

VON DUPRIN®

Price book 9

Effective April 3, 2021

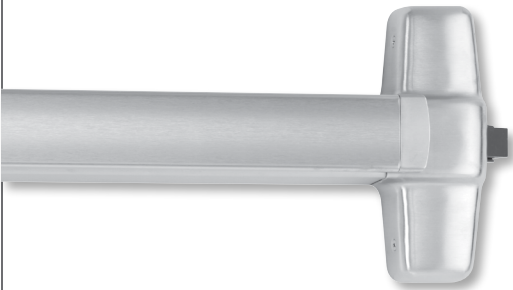
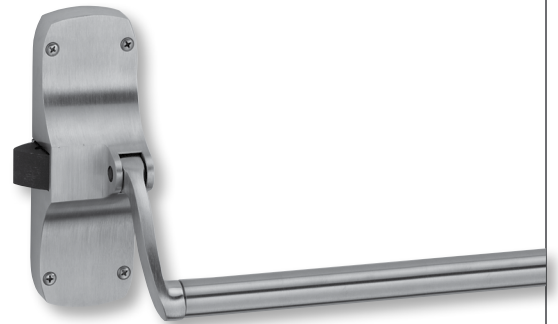

Customer Care

Our Customer Care Representatives are available for questions or assistance.

877-671-7011

Customer service

☎ Press **1**
✉ support@allegion.com

Technical support

☎ Press **2**
✉ Exits_TechProdSupport@allegion.com

For new projects or to locate an authorized distributor

☎ Press **3**

Administrative offices

Allegion administrative office

11819 N. Pennsylvania St.
Carmel, IN 46032
allegion.com/us

Placing orders

You can place orders with Allegion via the fax number or email listed below:

Email: Allegion_Orders@allegion.com
Fax#: 1-800-999-0328

Engineering Special Product Quotes

Email: VDI_Specials@allegion.com
Fax #: 1-877-730-6248

Request for quote

Carolinas

(North Carolina, South Carolina, Virginia)
Carolinas.Quotes@allegion.com

Central

(Arkansas, Illinois, Iowa, Kansas, Missouri, Nebraska, Oklahoma)
Central.Quotes@allegion.com

Chicago

(Illinois-Northern, Wisconsin)
Chicago.Quotes@allegion.com

Florida

Florida.Quotes@allegion.com

Great Lakes

(New York, Pennsylvania)
GreatLakes.Quotes@allegion.com

Metro New York

Metro.Quotes@allegion.com

Michigan

Michigan.Quotes@allegion.com

Mid Atlantic North

(New York, Pennsylvania)
Mid.Atlantics.North.Quotes@allegion.com

Mid Atlantic South

(Delaware, Maryland, New Jersey)
Mid.Atlantics.South.Quotes@allegion.com

Midwest

(Indiana, Kentucky, Ohio, West Virginia)
Midwest.Quotes@allegion.com

Mountain States

(Colorado, Idaho, Montana, Nevada, Utah, Wyoming)
Mtn.States.Quotes@allegion.com

New England

(Connecticut, Main, Massachusetts, New Hampshire, Rhode Island, Vermont)
NewEngland.Quotes@allegion.com

North Central

(Minnesota, North Dakota, South Dakota)
NorthCentral.Quotes@allegion.com

Northern California

NoCal.Quotes@allegion.com

Northwest

(Alaska, Oregon, Washington)
Northwest.Quotes@allegion.com

South

(Alabama, Georgia, Louisiana, Mississippi, Tennessee)
South.Quotes@allegion.com

Southern California

(California-Southern, Hawaii)
SoCal.Quotes@allegion.com

Southwest

(Arizona, New Mexico)
Southwest.Quotes@allegion.com

Texas

Texas.Quotes@allegion.com

Contents

Doing business with Allegion	5	98/99 Series	81
About the Allegion Catalog Nomenclature (ACNs)	6	98/99 Series Overview	81
Styles	7	98/99 Series Configure a product.....	86
General information	11	Rim devices	86
How to order	12	Surface vertical rod devices (27).....	87
Mortise lock order form	13	Concealed vertical rod devices (47).....	88
Special order products	14	Wood Door Concealed vertical rod devices (47-WDC)	89
Exit devices	19	Wood Door Concealed vertical rod devices (47-WDC)	90
22 Series	20	Concealed vertical rod devices (48)	91
22 Series Overview	20	Surface three point latch devices (57)	92
22 Series Configure a product.....	23	Mortise lock devices (75).....	93
Rim devices	23	Concealed vertical cable devices (49)	94
Surface vertical rod devices (27A).....	24	Wood Door Concealed vertical cable devices (50-WDC) ...	95
Options.....	25	Pool exit hardware (52)	96
Parts and accessories.....	26	Options.....	97
33A/35A Series	28	Kits.....	102
33A/35A Series Overview	28	Parts and accessories.....	104
33A/35A Series Configure a product.....	33	XP98/XP99 Series	114
Rim devices	33	XP98/XP99 Series Overview.....	114
Surface vertical rod devices (27A).....	34	XP98/XP99 Series Configure a product	118
Concealed vertical rod devices (47A)	35	Rim devices	118
Concealed vertical rod devices		Options.....	119
for hollow metal doors (48A)	36	Kits.....	122
Options.....	39	Parts and accessories.....	123
Kits.....	43	94/95 Inpact Series.....	124
Parts and accessories.....	45	94/95 Series Overview.....	124
55 Series	53	94/95 Series Configure a product	127
55 Series Overview	53	Concealed vertical rod devices (47)	127
55 Series Configure a product.....	56	Concealed vertical rod devices (48)	128
Rim devices	56	Mortise lock devices (75).....	129
Concealed vertical rod devices (47).....	57	Options.....	130
Wood Door Concealed vertical rod devices (47-WDC)	58	Kits.....	130
Mortise lock devices (75).....	59	Parts and accessories.....	131
Options.....	60	2670 Guard-X Series	132
Parts and accessories.....	61	2670 Guard-X Series Overview.....	132
88 Series	66	2670 Guard-X Configure a product	134
88 Series Overview.....	66	Parts and accessories.....	134
88 Series Configure a product	70		
Rim devices	70		
Surface vertical rod devices (27).....	71		
Concealed vertical rod devices (47).....	72		
Mortise lock devices (75).....	73		
Options.....	74		
Parts and accessories.....	75		

- 22 SERIES
- 33A/35A SERIES
- 55 SERIES
- 88 SERIES
- 98/99 SERIES
- XP98/XP99 SERIES
- 94/95 SERIES
- GUARD-X SERIES
- ACCESSORIES / PARTS
- ELECTRICAL / PARTS

Accessories and parts..... 135

Dummy cross/touch bars..... 136

Strikes..... 137

Trims..... 139

 22 Series..... 139

 33A/35A Series..... 139

 55 Series..... 140

 88 Series..... 140

 98/99 Series..... 141

 94/95 Series..... 143

 Parts and accessories..... 144

Control trims..... 151

 360 Series..... 151

 370 Series..... 152

 Parts and accessories..... 153

Cylinder controls..... 158

Cover plates, cylinders and glass bead kits..... 159

Mullions..... 160

Rod and latch guards..... 162

Mortise locks..... 163

237 Two point latch..... 164

Extension rod kits..... 166

Security screw packages..... 167

Sex bolts..... 168

SLM blocking mounting packages..... 168

Screw packs/Shims/Miscellaneous..... 169

Maintenance kit and replacement packages..... 170

Service replacement parts..... 171

Electrical products and parts 173

Alarm kits..... 174

Mortise locks..... 175

Switches..... 175

Delayed exit system..... 176

Interface boxes/relays..... 176

Allegion Connect..... 177

Electric power transfers..... 177

Power supplies..... 178

Electric strikes..... 180

Schlage® Electronic exit trim..... 185

Electrified kits..... 191

Part number cross reference..... 195

Wiring diagrams..... 197

Policies and Documents

The purchase of Allegion products is governed by the Allegion Authorized Seller Program. For program terms and conditions, and other program details, please visit: www.allegion.com/AuthorizedSeller.

For Warranty information, visit us.allegion.com/warranty or contact Customer Service at 877-671-7011.

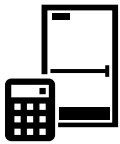

ONLINE ORDERING IS AVAILABLE THROUGH ESTIMATE TO ORDER (ETO)

ETO offers much more than placing online orders including:

- Net price and list price are both displayed based on your buying program.
- Configure products, build hardware sets and place an order, or you can export to Excel.
- Build a dynamic cross-reference between your part numbers and Allegion part numbers. Any time a description, price or other product data is changed, your cross-reference will automatically be updated.
- Request a quote or quote revision directly from an estimate

Visit <http://360portal.allegion.com> to get started or email online.ordering.access@allegion.com to sign up.

To learn more about how ETO works and its features, visit: us.allegion.com/ETODirect.

Traditional ordering methods:

Email: allegion_orders@allegion.com

Fax: 1-800-248-1460

When using traditional ordering methods, list the product attributes in the order outlined in this price book, which follow the ACN format guidelines.

You can **configure and price a full range of products** using the tables and rules shown in this book.

THE SIMPLIFIED STRUCTURE OF PRICING AND PRODUCT DATA IN THIS BOOK CREATES AN EASIER CONFIGURATION EXPERIENCE AND A QUICKER UPDATE PROCESS FOR FUTURE PRICE INCREASES. PRICING LOGIC USED IN THIS FORMAT MAKES THE PRODUCT AND PRICE EASIER TO UNDERSTAND AND HAS ENABLED ALLEGION TO PROVIDE CUSTOMERS WITH A **DIGITAL DATA SET OF PRICING, AVAILABLE FOR DOWNLOAD AT** [HTTP://360PORTAL.ALLEGION.COM](http://360portal.allegion.com).

AS A RESULT, THE **HOW TO ORDER FORMATS HAVE BEEN UPDATED TO MATCH THE ALLEGION CATALOG NOMENCLATURE (ACN) LOGIC**. ACNS ARE DESCRIPTIVE, UNIQUE IDENTIFIERS THAT SET STANDARDS ON HOW TO ORDER PRODUCTS AND REQUIRE DEFAULT, CONSISTENT NAMING CONVENTIONS FOR ALL PRODUCT ATTRIBUTES ACROSS ALLEGION BRANDS.

For more information about ACNs, please visit us.allegion.com/acnsupport or email ACNHelp@allegion.com.

FINISHES

BHMA	US	DESCRIPTION
605	US3	Brass, Polished
606	US4	Brass, Satin
611	US9	Bronze, Polished
612	US10	Bronze, Satin
613	US10B	Bronze, Oil-Rubbed Satin
619	US15	Nickel, Satin
622	US19	Matte Black
625	US26	Chrome, Polished
626	US26D	Chrome, Satin
626AM	US26D-AM	Chrome, Satin with Antimicrobial Coating
628	US28	Aluminum, Anodized

BHMA	US	DESCRIPTION
629	US32	Stainless Steel, Polished
630	US32D	Stainless Steel, Satin
630AM	US32D-AM	Stainless Steel, Satin with Antimicrobial Coating
643e		Aged Bronze
689	SP28	Aluminum, Sprayed
693	SPBLK	Black, Paint (not flat powder)
695	SP313	Sprayed Duranodic
710	313	Duranodic Dark Bronze
711	315	Flat Black
721	US3A	Brass, Polished - no lacquer
728	US4A	Brass Satin - no lacquer

Note: See device finish pages for available finishes offered for each device.

SPLIT FINISHES:

When split finish is desired, the finish listed first is understood to be the finish on the trim/control on the outside of door.

TOUCHBAR TRIM FINISHES:

When purchased as part of a device, optional touchbar trims are furnished at no additional charge. See device finish page for available finishes per device.

SPECIAL FINISHES

Optional powder coat finishes available on 33A, 35A, 55, 88, 94, 95, 98, 99, XP98 and XP99 Series devices. To have a specific color matched and powder coat availability please contact:

TIGER Drylac U.S.A., Inc.
3945 Swenson Ave.
St. Charles, IL. 60174 USA
800-243-8148
www.tiger-coatings.us

Powder coat must be selected from Tiger Drylac **Series 38 or 49**.

Please specify both the full powder coat product number and the RAL number when placing your order with Von Duprin.

Example: 49/15320 RAL 1015

CUSTOM GRAPHICS

Custom logo or unique artwork on push bar trim is available. Must provide a graphic file of artwork to be applied. The graphic should be native (not scaled) and must not exceed 16"x2". File format should be in Photoshop or .TIFF file format. The graphic file should be emailed to VDI_Specials@allegion.com. Contact customer care for more details.

List add **\$98/device** plus non-discountable **\$250** set-up charge per order.

SPECIAL FINISH PRICING













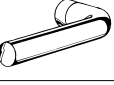

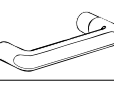



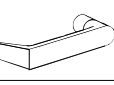

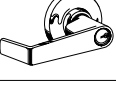









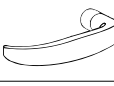













33A, 35A, 94, 95, 98, 99, XP98, XP99 devices 24% list add to 628 price
22 devices 24% list add to 689 price, special finishes limited to 622, 706, 691, and 693
55 and 88 devices..... 24% list add to 606 price
Steel Mullions..... 24% list add to 689 price

For other finishes not listed in this pricebook, consult factory for pricing.

REFERENCE

Devices ordered in 628 and 630 will be supplied with Trims in 630 unless SS levers are specified.

STANDARD LEVER DESIGNS

VON DUPRIN EXIT DEVICES 33A/35A, 94/95, 98/99	L-LOCK	ND	AL	S	F/FA
01 	01 				
02 	02 				
03 	03 	Tubular 			
05 	05 				
06 	06 	Rhodes 	Saturn 	Saturn 	Elan 
07 	07 	Athens 	Jupiter 	Jupiter 	Jazz 
12 	12 				Manhattan 
17 	17 	Sparta 	Neptune 	Neptune 	
18 	18 				
Latitude 	Latitude 				Latitude 
Longitude 	Longitude 				
16 	Omega 	Omega 	Omega 		
Asti 	Asti 			Flair 	Flair 
Merano 	Merano 				Merano 
Accent 	Accent 				Accent 

Note: Table shows matching lever styles among brands for suiting purposes.

M COLLECTION LEVER DESIGNS (CAST OR FORGED)

M51

Tactile option: 851 (knurled)

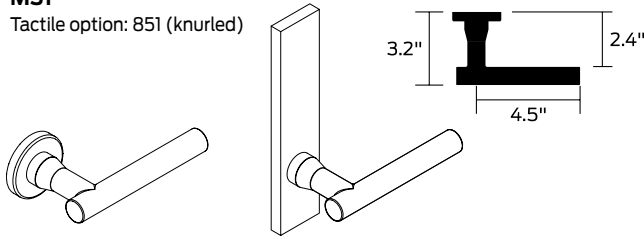

M52

Tactile option: 852 (knurled)

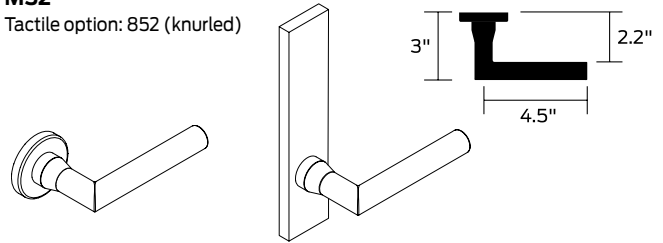

Available roses: A (shown), B, C

Available escutcheons: L (shown), N

Available roses: A (shown), B, C

Available escutcheons: L (shown), N

M53

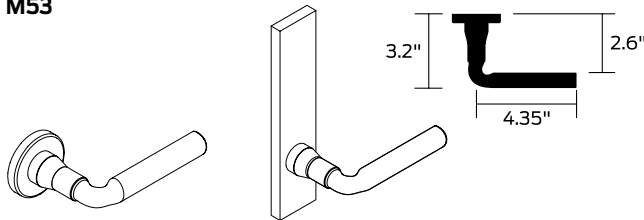

M54

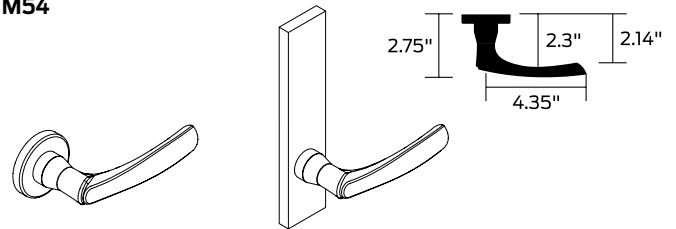

Available roses: A (shown), B, C

Available escutcheons: L (shown), N

Available roses: A (shown), B, C

Available escutcheons: L (shown), N

M55

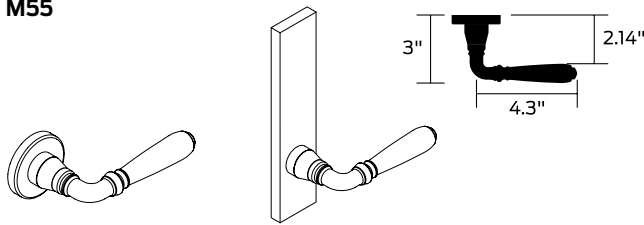

M56

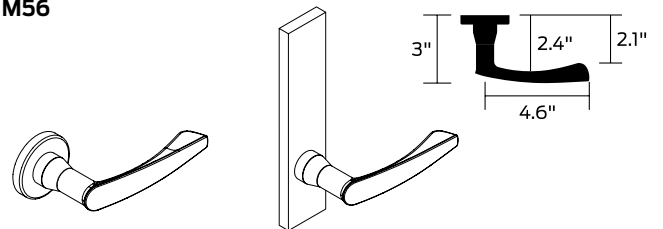

Available roses: A (shown), B, C

Available escutcheons: L (shown), N

Available roses: A (shown), B, C

Available escutcheons: L (shown), N

M57

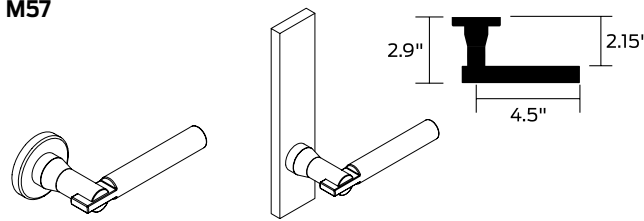

M61

Handing required

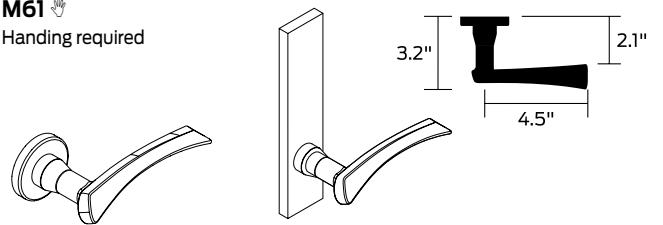

Available roses: A (shown), B, C

Available escutcheons: L (shown), N

Available roses: A (shown), B, C

Available escutcheons: L (shown), N

M62

Handing required

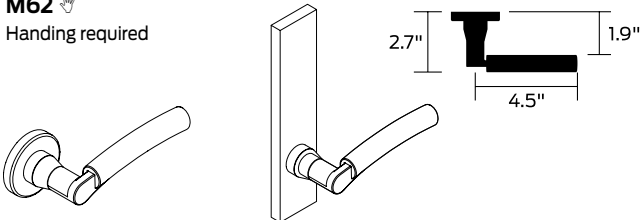

M63

Handing required

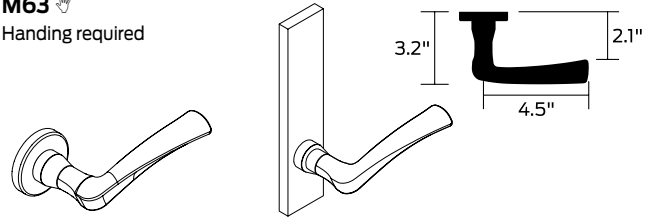

Available roses: A (shown), B, C

Available escutcheons: L (shown), N

Available roses: A, B (shown), C

Available escutcheons: L (shown), N

M COLLECTION LEVER DESIGNS (CAST OR FORGED)

M81

Tactile option: 881 (knurled)

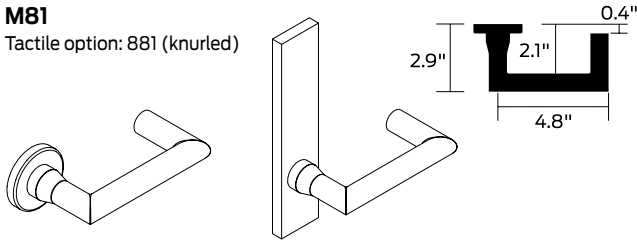

M82

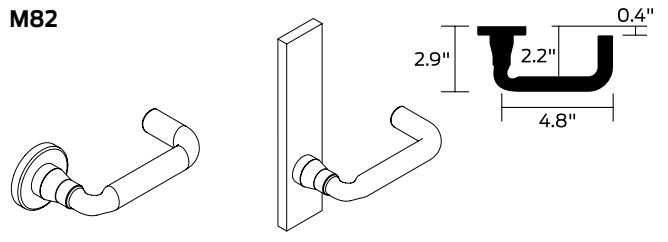

Available roses: A, AVA, B (shown), C

Available escutcheons: L (shown), N

Available roses: A (shown), B, C

Available escutcheons: L (shown), N

M83

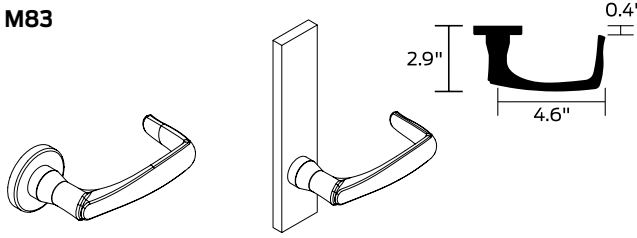

M84

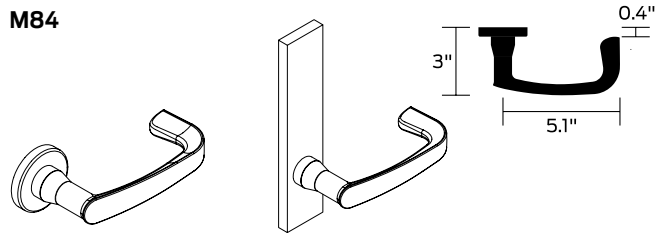

Available roses: A (shown), B, C

Available escutcheons: L (shown), N

Available roses: A, B (shown), C, MER

Available escutcheons: L (shown), N

M85

Handing required

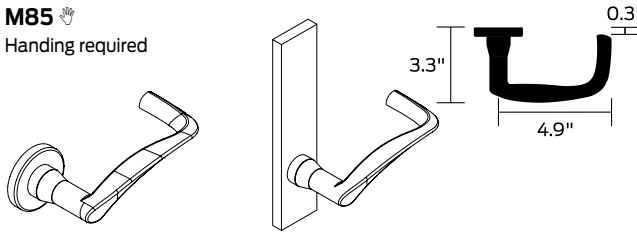

ME1

Tactile option: 8ME1 (milled)

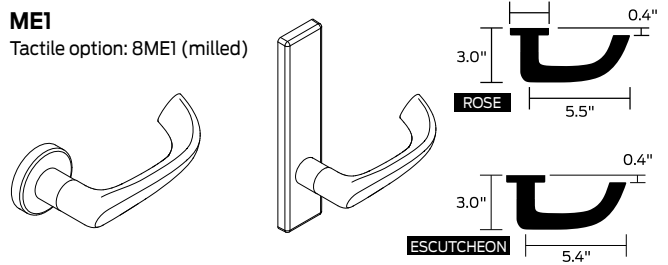

Available roses: A (shown), B, C

Available escutcheons: L (shown), N

Available roses: A (shown), B, C

Available escutcheons: L (shown), N

ME2

Tactile option: 8ME2 (milled)

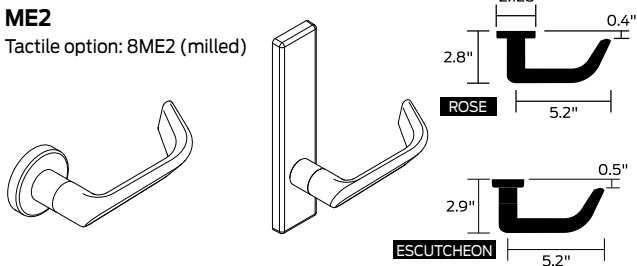

ME3

Tactile option: 8ME3 (milled)

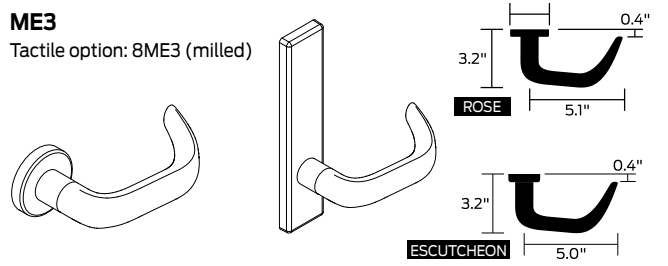

Available roses: A (shown), B, C

Available escutcheons: L (shown), N

Available roses: A (shown), B, C

Available escutcheons: L (shown), N

DOOR WIDTHS

EXIT DEVICES for door widths exceeding 4'0" are custom applications. Door width is assumed 3'0" unless specified otherwise. Specify the exact door width and consult factory for price or see page 17.

DOOR THICKNESS

EXIT DEVICES are furnished at prices listed for door thicknesses of 1-3/4" and 2-1/4" with standard centerlines. Other door thicknesses and/or offset installations may require additional charges for the device, trim, control and/or strike. Consult factory for price or see pages 15, 16, and 17. Some extended door thickness applications are standard, see device option pages.

DOOR HEIGHTS/DEVICE CENTERLINE

SURFACE VERTICAL ROD DEVICES are furnished at prices listed for door heights up to 7'0". For heights above 7'0", extension rods are furnished at prices shown on page 166. For doors higher than 10'0" or when centerline is other than standard, specify exact height and/or centerline. Consult factory for price or see device page. ADA centerline of 37" is available at no additional charge, must be specified. Door height is assumed 7'0" unless specified otherwise.

CONCEALED VERTICAL ROD DEVICES are furnished at prices listed for door heights 6'8" to 8'4" on touch bar devices, and up to 8'0" on crossbar devices. For extension rods up to 10'0", see page 166 for prices. For heights other than this or when centerline is other than standard, specify exact height. Consult factory for price or see device page. Door height is assumed 7'0" unless specified otherwise.

HANDING

DEVICES: Furnished RHR when handing is not specified.

LEVER TRIMS: Trims are furnished RHR when handing is not specified.

CYLINDERS

We do not offer custom keying.

MARKING CARTONS

Markings (e.g., door locations, stock reference numbers) on acknowledgements and individual product cartons will be provided at no additional charge.

SUBSTITUTION OF OUTSIDE TRIM OR STRIKES

When standard is not desired, deduct price of standard and add price of item used. Check catalog for compatibility. Refer to device Product Catalogs for specific door application strike requirements.

ELECTRIC ACCESSORIES

When specifying Electrical Products, consult Product Catalog or factory to insure all required accessories have been specified.

PRODUCT CATALOGS

Refer to the Product Catalogs for required accessories and specific requirements.

LEVER DESIGNS

- The #06 lever is furnished standard.
- Optional lever designs, #01, #02, #03, #05, #07, #12, #16, #17, #18, Accent, Asti, Merano are available at no additional charge.
- Optional Stainless Steel levers, 03 SS, 06 SS, 17 SS, Latitude SS and Longitude SS are available at no additional charge.
- Optional Brass levers, Latitude and Longitude are available at no additional charge.
- Optional Knurled Levers available on #02, 03, 07, and 17 Lever designs. M51, M52, and M81 lever designs can be supplied Knurled as a Special. Refer to device pages for Levers offered per device.



605	606	611	612	613	619	622	625	626	626AM	628	629
US3	US4	US9	US10	US10B	US15	US19	US26	US26D	US26DAM	US28	US32
630	630AM	643e	689	691	693	695	706	710	711	721	728
US32D	US32DAM	-	SP28	SP10	SPBLK	SP313	SP4	313	315	US3A	US4A

Prefix	Device series/type		Trim/rating		Suffix/finish		Door width	Handing	Less bottom rod/cable	Trim options/finish	Strike/lever style	Accessories	Other information												
1	2	3	4	5	6	7	8	9	10	11	12	13	14												
QEL	-	98	-	27	-	L	-	F	-	-	626	-	3'	-	RHR	-	LBR	-	996/626	-	299F/06	-	SNB	-	HM

Detail

1 Prefixes

None	Standard
AX	Accessible device
CD	Cylinder dogging - panic only
CX	Chexit
E	Electric locking mortise/lever
EL	Electric latch retraction
HH	Hurrican device
LX	Latch bolt monitoring
PL	Pullman latch
PN	Pneumatic latch retraction
QEL	Quiet electric latch retraction
QM	Quiet mechanical
RX	Request to exit
RX2	Double request to exit
SD	Special dogging -panic only
SS	Signal switch
WS	Windstorm (FEMA rated) surface vertical rod device
XP	Heavy protection - rim

2 Device series

22	Push bar device
33A/35A	Push bar device
55	Cross bar device
88	Cross bar device
94/45	Recessed device
98/99	Push bar device

3 Device type

None	Rim device
27	Surface mounted vertical rod device
47	Concealed vertical rod device
47WDC	Concealed vertical rod wood door device
48	Concealed vertical rod device
49	Concealed vertical cable device (see CVC how to order form)
50WDC	Concealed vertical cable wood door device
52	Rim device with remote trim input (pool exit hardware)
57	Three-point latch device
75	Mortise lock device

4 Trim functions

EO	AD trim (to come from client)
DT	Dummy trim
EO	Exit only
HL	Hospital pull trim
K	Knob
K-BE	Knob - blank escutcheon

4 Trim functions

K-DT	Knob, rigid - dummy trim
K-NL	Knob, rigid - night latch
L	Lever (classroom)
L-BE	Lever - blank escutcheon
L-DT	Lever, rigid - dummy trim
L-NL	Lever, rigid - night latch
NL	Night latch
NL-OP	Night latch cylinder assembly, optional pull
TL	Turn lever
TL-BE	Turn lever - blank escutcheon
TP	Thumbpiece
TP-BE	Thumbpiece - blank escutcheon

5 Rating

F	Fire exit hardware
Blank	Panic exit hardware

6 Suffix

-2	Double cylinder (rim and mortise only)
-2SI	Double cylinder with security indicator (rim only)
CON	Connectors
WH	Weep holes

7 Finish

605	Bright Brass
606	Satin Brass
612	Satin Bronze
619	Satin Nickel
625	Bright Chrome
626	Satin Chrome
626AM	Satin Chrome, Antimicrobial
628	Aluminum, Anodized
630	Satin Stainless
630AM	Satin Stainless, Antimicrobial
643e	Aged Bronze
710	Dark Brown, Anodized
711	Flat Black

8 Door width Door thickness

3'	Standard default	1 3/4"	Standard
4'		2 1/4"	Optional
2'			

9 Handing

LHR	Left hand reverse
RHR	Right hand reverse

10 Less bottom rod/cable

LBR	Less bottom rod
LBL	Less bottom latch
LBR-AFL	LBR with fire pin
LBL-AFL	LBL with fire pin

11 Trim options/finish

See trim options/finish for each device type

12 Lever style

06	Standard default (optional levers available)
-----------	--

13 Accessories

CYL	Cylinder
GBK	Glass bead kit
SEC	Security screws
SLM	SLM blocking
SNB	Sex bolts

14 Other information

Touchbar options

BRAILLE	Vision impaired touchpad, raised letter, and braille
EMB	Touchbar trim embossed 'PUSH'
RSS	Red silk-screened lettered touchbar trim
KN	Knurled touchbar
SG	Safety glow

Miscellaneous

CE	CE labeled
LCP	Less cover plate
10WDA	#10WDA cover plate
RAT REL	Ratchet release assy

Door material

ALD	Aluminum door
HMD	Hollow metal
WD	Wood door
CP	Composite door
INS2	Insulclad - 1/2"
INS4	Insulclad - 1/4"
SC	Steelcraft, HH device only

Door application

DE	Double egress
PR	Pair of doors
SLG	Single door

Note: Not all options are listed. Not all options are available on all series. See the specific series pages for complete options available. Please contact customer care for questions.

MORTISE LOCK ORDER FORM

For door thickness between 2 1/4" - 4 1/2". See page 15 for pricing.

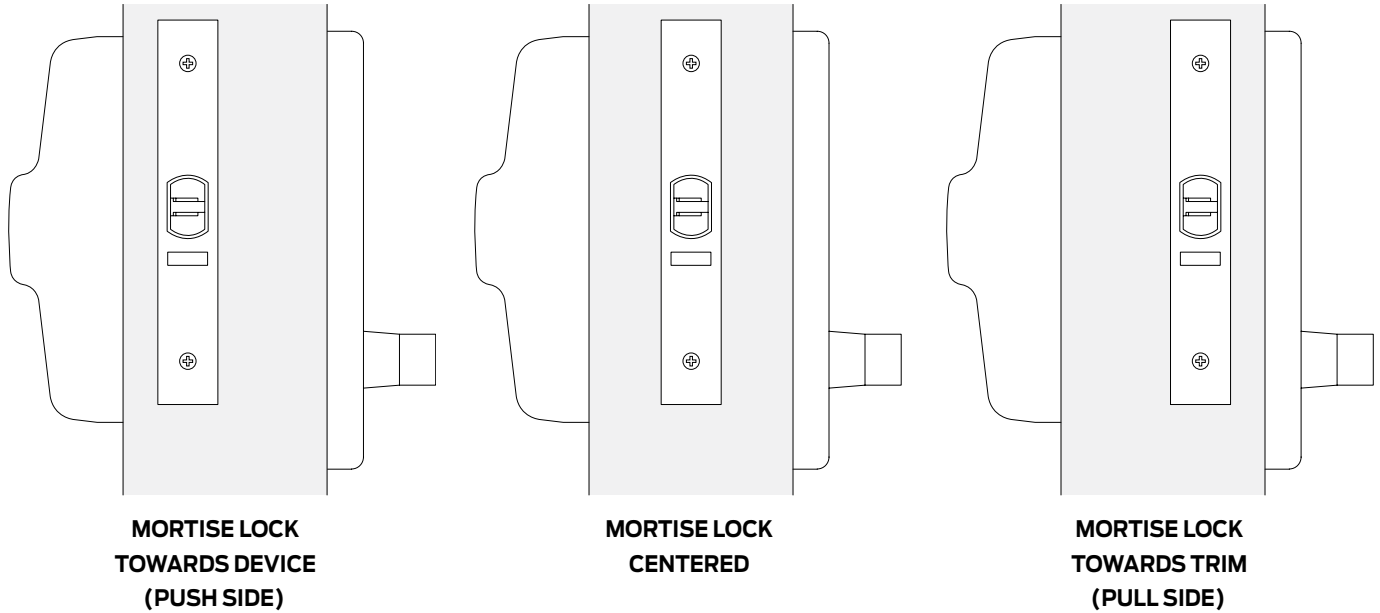

1. SELECT MORTISE LOCK POSITION (USING ILLUSTRATION ABOVE). Please check box in left column to indicate lock location.

	Push side. Please provide centerline dimension from push side .
	Center. Please provide centerline dimension from center .
	Pull side. Please provide centerline dimension from pull side .

2. SPECIFY DOOR THICKNESS.

	Please provide door thickness in box to the left.
--	--

3. SPECIFY MORTISE LOCK CONFIGURATION (5575 / 8875 / 98/9975 / -F). Example: 9875-EO x 3' x US26D.

PRODUCTS TO BE SUPPLIED:

<p>Mortise device - lock towards device (push) side</p> <ul style="list-style-type: none"> ▪ Special strike ▪ Special screw pack ▪ Special trim (if not EO) 	<p>Mortise device - lock centered</p> <ul style="list-style-type: none"> ▪ Special device ▪ Special strike ▪ Special trim (if not EO) 	<p>Mortise device - lock towards trim (pull) side</p> <ul style="list-style-type: none"> ▪ Special device
--	--	--



22 SERIES

33A/35A SERIES

55 SERIES

88 SERIES

98/99 SERIES

XP98/XP99 SERIES

94/95 SERIES

GUARD-X SERIES

ACCESSORIES / PARTS

ELECTRICAL / PARTS

SPECIAL ORDER PRODUCTS

DOOR THICKNESS - DEVICES ONLY

Prices shown are for a door thickness over 2-1/4" up to 4-1/4".

Trims for a door thickness other than standard are priced separately on pages 16 and 17.

22 SERIES			
Description	Specify	Price adjustment	Notes
No specials are available on the 22 Series	22	\$,0.00	

55 SERIES			
Description	Specify	Price adjustment	Notes
Rim Device	55	\$96.00	Special Screw Pack
Mortise Device, Lock towards device (push) side	5575/5575-F	\$302.00	Special Device Special Screw Package Special Trim (if not EO)
Mortise Device, Lock centered		\$580.00	Special Device Special Strike Special Trim (if not EO)
Mortise Device, Lock towards trim (pull) side		\$558.00	Special Device
Concealed Vertical Rod Device	5547/5547WDC/-F	\$96.00	Special Screw Pack

88 SERIES			
Description	Specify	Price adjustment	Notes
Rim device with sexbolts	88/88-F	\$96.00	Special Screw Pack
Mortise Device, Lock towards device (push) side	8875/8875-F	\$294.00	Special Strike Special Screw Package Special Trim (if not EO)
Mortise Device, Lock centered		\$563.00	Special Device Special Strike Special Trim (if not EO)
Mortise Device, Lock towards trim (pull) side		\$259.00	Special Device Special Screw Package

98/99 SERIES			
Description	Specify	Price adjustment	Notes
Mortise Device Lock towards Device(Push) Side	98/9975/-F	\$302.00	Special Strike Special Screw Package Special Trim (if not EO)
Mortise Device Lock Centered		\$580.00	Special Device Special Strike Special Trim (if not EO)
Mortise Device Lock towards Trim(Pull) Side		\$268.00	Special Device Special Screw Package

NOTE: Other special door and frame conditions may require additional charges. Consult factory for pricing.

Location of Mortise Lock must be provided when ordering. Please use forms on page 13 to provide correct information.

22 SERIES
 33A/35A SERIES
 55 SERIES
 88 SERIES
 98/99 SERIES
 XP98/XP99 SERIES
 94/95 SERIES
 GUARD-X SERIES
 ACCESSORIES / PARTS
 ELECTRICAL / PARTS

DOOR THICKNESS - TRIMS ONLY

Prices shown are for a door thickness over 2-1/4" up to 4-1/4".
See specific product below for maximum door thickness. Devices for a door thickness other than standard are priced separately on page 15.

33A/35A SERIES TRIM			
Description	Specify	Price adjustment	Notes
Dummy or Night Latch Trim	386DT and NL	\$96.00	Screw Pack for Device
Night Latch Cylinder Trim - 33A/35A	388	\$96.00	Screw Pack for Device
Dummy Trim	550DT	\$96.00	Screw Pack
Dummy Trim	392-6	\$96.00	Screw Pack
Thumbturn	360T and TBE	\$139.00	

55 SERIES TRIM			
Description	Specify	Price adjustment	Notes
Dummy Trim	550DT	\$96.00	Screw Pack
Night Latch Trim	555NL/556NL	\$96.00	Screw Pack
Night Latch Cylinder Assembly	555NL-CA/556NL-CA	\$96.00	Screw Pack
Night Latch Cylinder Assembly	110MD-NL/WD-NL	\$96.00	Screw Pack

88 SERIES TRIM			
Description	Specify	Price adjustment	Notes
Exit Only, Dummy or Night Latch Trim	880EO, DT or NL	\$96.00	Screw Pack
Thumbpiece, up to 3-1/4"	880/608TP/TP-BE	\$257.00	Thumbpiece and Screw Pack
Thumbpiece, over 3-1/4" up to 4-1/4"		\$431.00	Thumbpiece and Screw Pack
Knob, up to 4-1/4"	880/606K/K-BE/K-NL	\$326.00	Spindle and Screw Pack
Knob Dummy	880K-DT	\$96.00	Screw Pack
Dummy or Night Latch Trim	608DT or NL	\$96.00	Screw Pack
Knob Dummy	606K-DT	\$96.00	Screw Pack

98/99 SERIES TRIM			
Description	Specify	Price adjustment	Notes
Exit Only, Dummy or Night Latch Trim	990EO, DT or NL	\$96.00	Screw Pack
Dummy or Night Latch Trim	696/697DT or NL	\$96.00	Screw Pack
Thumbpiece, up to 4-1/4"	990/696/697TP/TP-BE	\$266.00	Thumbpiece and Screw Pack
Knob	996K/K-BE/K-NL	\$315.00	Spindle and Screw Pack
Knob Dummy	996K-DT	\$96.00	Screw Pack
Exit Only Plate	996EO	\$178.00	Screw Pack and Studs
Lever up to 4"	996L/L-BE	\$558.00	Finger and Studs
Night Latch Lever up to 4"	996L-NL	\$112.00	Studs
Lever Dummy up to 4"	996L-DT	\$112.00	Screw Pack
Dummy Trim	392-7	\$92.00	Screw Pack

NOTE: Other special door and frame conditions may require additional charges. Consult factory for pricing.

DOOR THICKNESS - CONTROLS ONLY

Prices shown are for a door thickness over 2-1/4" up to 4-1/4".

Devices for a door thickness other than standard are priced separately on page 15.

CONTROLS			
Description	Specify	Price adjustment	Special items required
Lever	371L/LBE	\$337.00	Cam and Screw Pack
Lever, up to 3-3/8" dr for 88L	373L/L-BE	\$94.00	Screw Pack
Lever, over 3-3/8" up to 4-1/4" for 88L		\$452.00	Spindle and Screw Pack
Lever, up to 2-11/16" for 8827L		\$94.00	Screw Pack
Lever, over 2-11/16" up to 4-1/4" for 8827L		\$452.00	Spindle and Screw Pack
Lever, up to 3-5/8" for 8875L		\$94.00	Screw Pack
Lever, over 3-5/8" up to 4-1/4" for 8875L		\$452.00	Spindle and Screw Pack
Lever Dummy	373L-DT	\$94.00	Screw Pack
Lever, up to 3-5/8" for 5575L	375L/L-BE	\$94.00	Screw Pack
Lever, over 3-5/8" up to 4-1/4" for 5575L		\$452.00	Spindle and Screw Pack
Lever Dummy	375L-DT	\$94.00	Screw Pack
Lever	378L/L-BE	\$337.00	Cam and Screw Pack
Lever	379L/L-BE	\$452.00	Spindle and Screw Pack
Thumbturn	374T/T-BE	\$263.00	Rod Member and Screw Pack
Thumbturn	376T/T-BE	\$472.00	Rod Cam and Screw Pack
Thumbturn	376T-WDC/T-BE	\$472.00	Rod Member and Screw Pack
Thumbturn, 2" door	377T/T-BE	\$252.00	Rod Cam and Screw Pack
Thumbturn, over 2 1/4" door	377T/T-BE	\$472.00	Rod Cam and Screw Pack

DOOR WIDTH - DEVICES ONLY

Prices shown are for door widths over 4' up to 6'.

33/35/98/99 SERIES			
Description	Specify	Price adjustment	Notes
All finishes	> 4' up to 5'	\$235.00	Device will ship less label

33/35/98/99 SERIES			
Description	Specify	Price adjustment	Notes
All finishes	> 5' up to 6'	\$322.00	Device will ship less label

55 OR 88 SERIES			
Description	Specify	Price adjustment	Notes
626 or 625	> 4' up to 5'	\$287.00	Device will ship less label
605, 606, 612, 613, 693	> 4' up to 5'	\$450.00	Device will ship less label

Note: Device will be supplied with a 49" reinforcement crossbar kit. Actual crossbar length is 54".

For Special Order Product Quotes: Email: VDI_Specials@allegion.com Fax: 1-877-730-6248

DOOR WIDTH - DEVICES ONLY

Prices shown are for door widths over 4' up to 6'.

55 OR 88 SERIES			
Description	Specify	Price adjustment	Notes
626 or 625	> 5' up to 6'	\$376.00	Device will ship less label
605, 606, 612, 613, 693	> 5' up to 6'	\$543.00	Device will ship less label

Note: Device will be supplied with a 61" reinforcement crossbar kit. Actual crossbar length is 66".

For Special Order Product Quotes: Email: VDI_Specials@allegion.com Fax: 1-877-730-6248

SPECIAL DEVICE TYPES		
Description	Price adjustment	Notes
Modified California Special - Centerline at 38"	\$556.00	5547WDC Only
Balanced Door - 3' Device with 4' Mechanism Case	\$97.00	33/35/98/99 Series

SPECIAL TRIMS		
Description	Price adjustment	Notes
990 with 697 Pull	\$84.00	

SPECIAL ELECTRIC STRIKE		
Description	Price adjustment	Notes
6221/6223/6226 with "A" Back Box	\$90.00	

SPECIAL MULLION		
Description	Price adjustment	Notes
Aluminum Mullions >10' up to 11'	\$904.00	5654/5754
Steel Mullions >10' up to 14'	\$604.00	1654/4754/4854/4954/9854/9954

SPECIAL CENTERLINE (OTHER THAN 39-11/16")		
Description	Price adjustment	Notes
Steel Mullion	\$100.00	
Aluminum Mullion	\$466.00	

ADA centerline height of 37" is available at no additional charge, must be specified.

EXIT DEVICES

EXIT DEVICES
22 SERIES
33A/35A SERIES
55 SERIES
88 SERIES
98/99 SERIES
XP98/XP99 SERIES
94/95 SERIES
GUARD-X SERIES
ACCESSORIES / PARTS
ELECTRICAL / PARTS

22 SERIES

605	606	611	612	613	619	622	625	626	626AM	628	629
US3	US4	US9	US10	US10B	US15	US19	US26	US26D	US26DAM	US28	US32
630	630AM	643e	689	691	693	695	706	710	711	721	728
US32D	US32DAM	-	SP28	SP10	SPBLK	SP313	SP4	313	315	US3A	US4A

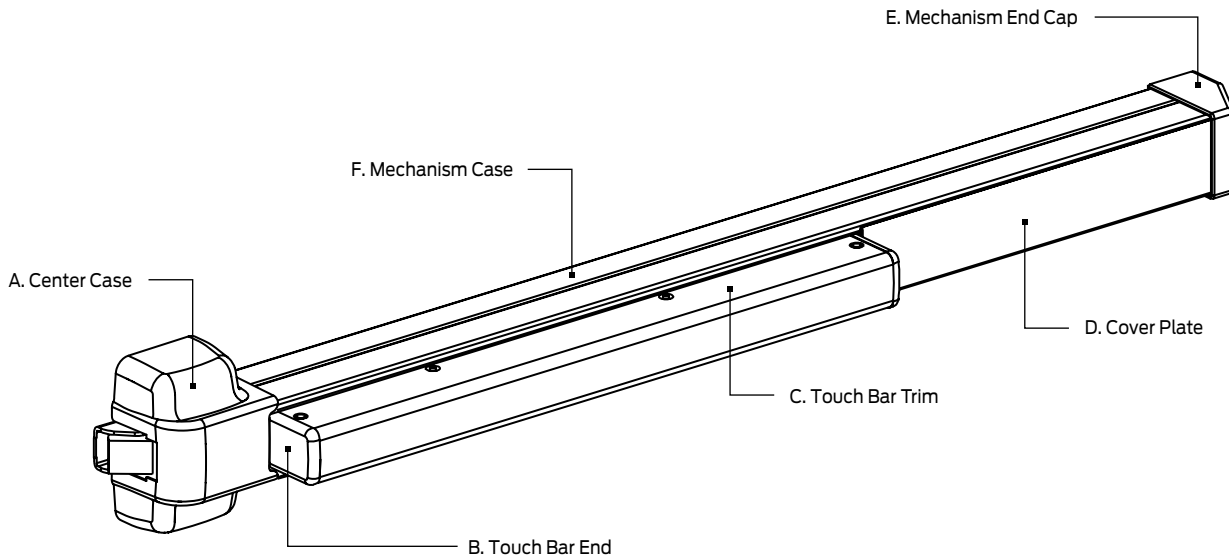

STANDARD FINISHES					
COLOR	US NUMBER	BHMA NUMBER	A, B, E	C - TOUCH BAR TRIM FINISHES	D, F
Sprayed Aluminum	SP28	689	(A) Powder Coat (B, E) Molded Plastic	Sprayed Aluminum, 689 (SP28)	Powder Coat
Duranodic Dark Bronze	SP313	695	(A) Powder Coat (B, E) Molded Plastic	Powder Coat, 695 (SP313)	Powder Coat

22 SERIES SEX BOLT QUANTITIES			
APPLICATION	SEX BOLT 425 (OPTIONAL)	WITH 499 STRIKE 425 SEX BOLT (OPTIONAL)	325 SEX BOLTS FOR SURFACE VERTICAL LATCHES (SUPPLIED)
EO (exit only device)	6	8	4
NLOP Device with 110 MD/WD	6	8	4
EO Device with 230EO trim	2	4	4
K, KBE, DT or NL Device with 210 trim	2	4	4
L, LBE, TP or TPBE Device with 230 trim	2	4	4

Note: Sex bolts are supplied for use on wood and composite fire doors.

 Indicates products that have EPD documentation available and meet LEED v4.

22 SERIES

605	606	611	612	613	619	622	625	626	626AM	628	629
US3	US4	US9	US10	US10B	US15	US19	US26	US26D	US26DAM	US28	US32
630	630AM	643e	689	691	693	695	706	710	711	721	728
US32D	US32DAM	-	SP28	SP10	SPBLK	SP313	SP4	313	315	US3A	US4A

TYPE OF DEVICE	
22	2227
Rim	Surface Vertical Rod

FUNCTION			
EO: Exit Only	DT: Dummy Trim	L: Lever, 06 Standard	LBE: Lever, Blank Escutcheon
NL: Night Latch, Key Retracts	NLOP: Night Latch, Opt. Pull	K: Knob	KBE: Knob, Blank Escutcheon
TP: Thumbpiece	TPBE: Thumbpiece, Blank Escutcheon		

RATING	
None: Panic Exit Device	F: Fire Exit Device

DEVICE FINISH	
689: Sprayed Aluminum (SP28)	695: Duranodic Dark Bronze (SP313)

DEVICE LENGTH (FEET AND INCHES)	
3ft: 3' Device for 2' 4" - 3' Door	4ft: 4' Device for 2' 10" - 4' Door

DEVICE HANDING	
RHR: Right Hand Reverse	LHR: Left Hand Reverse

TRIM OPTIONS			
LT: Less trim	210: Standard for DT, NL and K trim	230: Standard for L, TP trim	110WD-NL / 110MD-NL: Night Latch Cyl-WD door/MD door

TRIM FINISH			
613: Satin Bronze-Oil Rubbed (US10B)	626: Satin Chrome (US26D)	628: Powder Coat Aluminum (US28)	695: Duranodic Dark Bronze, (SP313)

STRIKE FINISH			
613: Satin Bronze-Oil Rubbed (US10B)	622: Flat Black (US19)	626: Satin Chrome (US26D)	630: Satin Stainless (US32D)
695: Dark Bronze (SP313)			

DOGGING OPTIONS
LD: Less Dogging

DEVICE OPTIONS			
ALK: Standard Alarm Kit	SNB: Include # of Sex Bolts	GBK: Include GBK	CYL: Include Cylinder
SEC: Include Security Screws	AX: Accessible Device	RX: Request to Exit	LX: Latchbolt Monitoring

RODS FOR SURFACE VERTICAL DEVICES ONLY	
LBR: Less Bottom Rod	LBRAFL: LBR with Aux. Fire Pin

22 SERIES

605	606	611	612	613	619	622	625	626	626AM	628	629
US3	US4	US9	US10	US10B	US15	US19	US26	US26D	US26DAM	US28	US32
630	630AM	643e	689	691	693	695	706	710	711	721	728
US32D	US32DAM	-	SP28	SP10	SPBLK	SP313	SP4	313	315	US3A	US4A

MISC

CE: CE Labeled

CON: Connectors

DOOR MATERIAL

ALD: Aluminum Door

HMD: Hollow Metal

WD: Wood Door

CP: Composite Door

FRAME MATERIAL

ALF: Aluminum Frame

HMF: Hollow Metal Frame

WDF: Wood Frame

DOOR THICKNESS

DT1-3/4: 1-3/4" Standard

DT2: 2" thickness

DT2-1/4: 2-1/4" thickness

DOOR MODE/APPLICATION

DE: Pair Double egress doors

PR: Pair of doors

SGL: Single door

22 SERIES

605	606	611	612	613	619	622	625	626	626AM	628	629
US3	US4	US9	US10	US10B	US15	US19	US26	US26D	US26DAM	US28	US32
630	630AM	643e	689	691	693	695	706	710	711	721	728
US32D	US32DAM	-	SP28	SP10	SPBLK	SP313	SP4	313	315	US3A	US4A

Rim devices

ACN							PRICE BASED ON FINISH		Default trim, included
Device type	Function	Fire	Finish	Device size	Handing	Lever design	689 or 695		
EXIT HARDWARE							3' DEVICE PRICING SHOWN. 4' ADD \$19.00 LIST		
22	EO	.	[]	[]	.	[]	\$483.00		N/A
22	DT	.	[]	[]	.	[]	\$538.00		210DT
22	NL	.	[]	[]	.	[]	\$546.00		210NL
22	NL-OP	.	[]	[]	.	[]	\$623.00		110MD/WD
22	K ¹	.	[]	[]	.	[]	\$732.00		210K
22	K-BE	.	[]	[]	.	[]	\$732.00		210K-BE
22	L	.	[]	[]	[]	[]	\$727.00		230L
22	L-BE	.	[]	[]	[]	[]	\$727.00		230L-BE
22	TP	.	[]	[]	.	[]	\$726.00		230TP
22	TP-BE	.	[]	[]	.	[]	\$726.00		230TP-BE
FIRE EXIT HARDWARE							3' DEVICE PRICING SHOWN. 4' ADD \$19.00 LIST		
22	EO	F	[]	[]	.	[]	\$610.00		N/A
22	DT	F	[]	[]	.	[]	\$665.00		210DT
22	NL	F	[]	[]	.	[]	\$673.00		210NL
22	NL-OP	F	[]	[]	.	[]	\$750.00		110MD/WD
22	K	F	[]	[]	.	[]	\$859.00		210K
22	K-BE	F	[]	[]	.	[]	\$859.00		210K-BE
22	L	F	[]	[]	[]	[]	\$854.00		230L
22	L-BE	F	[]	[]	[]	[]	\$854.00		230L-BE
22	TP	F	[]	[]	.	[]	\$853.00		230TP
22	TP-BE	F	[]	[]	.	[]	\$853.00		230TP-BE

¹ K: Includes cylinder

DEFAULT ATTRIBUTES

Pricing includes default options shown below. Additional options and configurations available.

Cylinders:	Sex bolts	Door thickness	Center line
Included only for K function	Not included	1-3/4"	39-13/16"

Strike(s):

Exit hardware:

- Includes 299 strike

Fire exit hardware:

- Single door applications: Includes 299F strike
- Double door applications: 499F strike will be supplied at an additional \$112 list add

22 SERIES

605	606	611	612	613	619	622	625	626	626AM	628	629
US3	US4	US9	US10	US10B	US15	US19	US26	US26D	US26DAM	US28	US32
630	630AM	643e	689	691	693	695	706	710	711	721	728
US32D	US32DAM	-	SP28	SP10	SPBLK	SP313	SP4	313	315	US3A	US4A

Surface vertical rod devices (27A)

ACN							PRICE BASED ON FINISH	
Device type	Function	Fire	Finish	Device size	Handing	Lever design	689 or 695	
							Default trim, included	
EXIT HARDWARE							3' DEVICE PRICING SHOWN. 4' ADD \$19.00 LIST	
2227	EO	[]	[]				\$835.00	N/A
2227	DT	[]	[]				\$890.00	210DT
2227	NL	[]	[]				\$898.00	210NL
2227	NL-OP	[]	[]				\$975.00	110MD/WD
2227	K ¹	[]	[]				\$1,084.00	210K
2227	K-BE	[]	[]				\$1,084.00	210K-BE
2227	L	[]	[]	[]	[]		\$1,079.00	230L
2227	L-BE	[]	[]	[]	[]		\$1,079.00	230L-BE
2227	TP	[]	[]				\$1,078.00	230TP
2227	TP-BE	[]	[]				\$1,078.00	230TP-BE
FIRE EXIT HARDWARE							3' DEVICE PRICING SHOWN. 4' ADD \$19.00 LIST	
2227	EO	F	[]	[]			\$1,091.00	N/A
2227	DT	F	[]	[]			\$1,146.00	210DT
2227	NL	F	[]	[]			\$1,154.00	210NL
2227	NL-OP	F	[]	[]			\$1,231.00	110MD/WD
2227	K ¹	F	[]	[]			\$1,340.00	210K
2227	K-BE	F	[]	[]			\$1,340.00	210K-BE
2227	L	F	[]	[]	[]	[]	\$1,335.00	230L
2227	L-BE	F	[]	[]	[]	[]	\$1,335.00	230L-BE
2227	TP	F	[]	[]			\$1,334.00	230TP
2227	TP-BE	F	[]	[]			\$1,334.00	230TP-BE

¹ K: Includes cylinder

DEFAULT ATTRIBUTES

Pricing includes default options shown below. Additional options and configurations available.

Cylinders:	Sex bolts	Door thickness	Center line
Included only for K function	Included for latches	1-3/4"	39-13/16"

Strike(s):

- Exit hardware: Includes 299 top strike, 248L-4 and 304L bottom strikes
- Fire exit hardware: Includes 299F top strike and 304L bottom strike

OPTIONS

605	606	611	612	613	619	622	625	626	626AM	628	629
US3	US4	US9	US10	US10B	US15	US19	US26	US26D	US26DAM	US28	US32
630	630AM	643e	689	691	693	695	706	710	711	721	728
US32D	US32DAM	-	SP28	SP10	SPBLK	SP313	SP4	313	315	US3A	US4A

ROD OPTIONS

Description	Specify	Price adjustment
Less bottom rod <ul style="list-style-type: none"> Available with UL Fire Label at no additional charge on 2227-F devices. LBR devices must be ordered in pairs of vertical rod devices with one AFL kit per pair (one device LBR, second device LBRAFL). 	LBR	-\$124.00
Less bottom rod with auxiliary fire latch	LBRAFL	\$0.00

DOGGING - NOT FOR USE WITH FIRE EXIT HARDWARE

Description	Specify	Price adjustment
Less dogging for 22 Series Panic Devices	LD	\$0.00

SWITCHES (AVAILABLE ON ALL 22 SERIES DEVICES)

Description	Specify	Price adjustment
Request to Exit	RX	\$266.00
Waterproof Request to Exit	WPRX	\$384.00
Request to Exit Low Current	RXLC	\$309.00
Request to Exit Double Switch	RX2	\$331.00
Latchbolt Monitoring	LX	\$266.00
Latchbolt Monitoring Low Current	LXLC	\$309.00
Request to Exit / Latchbolt Monitoring combination	LXRX	\$402.00
Request to Exit / Latchbolt Monitoring combination Low Current	LXRXLC	\$483.00

ACCESSIBLE DEVICE

Description	Specify	Price adjustment
<ul style="list-style-type: none"> Accessible device compliant with the California Building Code (Section 11B-309.4) requirement for 5 lb. maximum operational force. Available on AX22, AX22-F Rim, AX2227-LBR, AX2227-LBR-F. Trim functions available EO, DT, NL, L, and LBE. 	AX	\$26.00

EXIT ALARM

Description	Specify	Price adjustment
<ul style="list-style-type: none"> Exit alarm available on 22 Series Panic and Fire Devices. Price includes switch - "RX" switch, "LX" is optional at no additional charge. To order Less switch, deduct \$266.00 list. For vertical rod tampering monitoring on Surface Vertical Devices, specify device with LX (Latch Bolt Monitor Switch). 9 volt battery included. 	ALK	\$586.00

CONNECTORS

Description	Specify	Price adjustment
Cross-category solution using interconnect components for electrified options. Available with ALK, LX, LXLC, LXRX, LXRXLC, RX and RXLC switches.	CON	\$0.00

PARTS AND ACCESSORIES

605	606	611	612	613	619	622	625	626	626AM	628	629
US3	US4	US9	US10	US10B	US15	US19	US26	US26D	US26DAM	US28	US32
630	630AM	643e	689	691	693	695	706	710	711	721	728
US32D	US32DAM	-	SP28	SP10	SPBLK	SP313	SP4	313	315	US3A	US4A

CENTER CASE

Description	Specify		Non-Finished	689,695
	Part number	Finish		
22/22-F Rim Center Case Less Cover	109012	-	\$315.00	-
2227/27-F Center Case Less Cover	CASE.107	-	\$253.00	-
22/22-F Center Case Cover	041174	.[Finish]	-	\$59.00
2227/27-F Center Case Cover	041175	.[Finish]	-	\$59.00
22 Center Case Cover Screw Pkg/4	090077	-	\$12.00	-
22 Series Mounting Package	900392	-	\$26.00	-
Control Link Pin Kit	050529	-	\$14.00	-
Retaining Ring Pkg/10	090107	-	\$14.00	-
NL Drive Screw Pkg/10	090074	-	\$22.00	-
2227 Latchbolt Pin Pkg/10	090079	-	\$14.00	-
22 Pushbar Stop	965409	-	\$14.00	-

PUSH BAR

Description	Specify				Non-Finished	689,695
	Part number	Device type	Size	Finish		
22 Series Push Bar - 3'	PBKIT	.[]	.3ft	.[Finish]	-	\$204.00
22 Series Push Bar - 4'	PBKIT	.[]	.4ft	.[Finish]	-	\$215.00

MECHANISM CASE

Description	Specify		Non-Finished	689,695
	Part number	Finish		
22 End Cap Kit	900981	-	\$22.00	-
22/2227 Cover Plate - 3' Dr	968595	.[Finish]	-	\$57.00
22/2227 Cover Plate - 4' Dr	968596	.[Finish]	-	\$57.00
22-F/2227-F Cover Plate - 4' Dr	969126	.[Finish]	-	\$57.00
22-F/2227-F Cover Plate - 3' Dr	969127	.[Finish]	-	\$57.00
22 ALK Cover Plate - 3' Dr	971470	.[Finish]	-	\$57.00
22 ALK Cover Plate - 4' Dr	971471	.[Finish]	-	\$57.00
22 Mechanism Case - 3' Dr	970035	.[Finish]	-	\$202.00
22 Mechanism Case - 4' Dr	970036	.[Finish]	-	\$213.00
227 Dog Key 5/32" Pkg/2	090005	-	\$22.00	-
227 Dog Key 5/32" Pkg/10	090085	-	\$76.00	-
Cover Plate Bearing Insert	968592	-	\$14.00	-
Touch Bar Cover Bearing Insert	966268	-	\$14.00	-

BASEPLATE

Description	Specify		Non-Finished	689,695
	Part number	Finish		
Baseplate Bumper Pkg/4	090038	-	\$13.00	-
Baseplate Return Spring Pkg/10	090039	-	\$14.00	-
Dogging Shaft Pkg/2	090040	-	\$14.00	-
Dogging Spring Pkg/2	090041	-	\$13.00	-

PARTS AND ACCESSORIES

605	606	611	612	613	619	622	625	626	626AM	628	629
US3	US4	US9	US10	US10B	US15	US19	US26	US26D	US26DAM	US28	US32
630	630AM	643e	689	691	693	695	706	710	711	721	728
US32D	US32DAM	-	SP28	SP10	SPBLK	SP313	SP4	313	315	US3A	US4A

BASEPLATE

Description	Specify		Non-Finished	689, 695
	Part number	Finish		
Dogging Adaptor Spring Pkg/2	090042	-	\$17.00	-
Dogging Adaptor Pkg/2	090043	-	\$14.00	-
Dogging Hook Pkg/2	090044	-	\$14.00	-
Baseplate Bearing Strip Pkg/2	090048	-	\$14.00	-
22 Centercase Spacer	47289674	-	\$14.00	-

VERTICAL LATCHES

Description	Specify		Non-Finished	689, 695
	Part number	Finish		
2227 Bottom Latch Retrofit Kit (for devices shipped before October 1998)	050090	.[Finish]	-	\$155.00
2227 Top Latch Retrofit Kit (for devices shipped before October 1998)	050091	.[Finish]	-	\$155.00
2227 Bottom Latch Kit Less Cover (for devices shipped after October 1998)	050401	-	\$155.00	-
2227 Top Latch Kit Less Cover (for devices shipped after October 1998)	050400	-	\$155.00	-
2227 PL Latch Kit Less Cover	050402	-	\$155.00	-
2227 Latch Case Cover	050566	.[Finish]	-	\$58.00
2227 Latch Case Cover Screw Pkg	900850	.[Finish]	-	\$14.00
2227 Latch Case Mtg. Bracket Kit (for devices shipped after October 1998)	050546	-	\$31.00	-
2227 Top Latch Compression Spring Pkg/10	090056	-	\$14.00	-
2227 Top Latch Spring Pkg/10	090057	-	\$14.00	-
2227 Bolt Return Spring Pkg/10	090065	-	\$14.00	-
2227 Top Latch Aux. Bolt Spring Pkg/10	090076	-	\$14.00	-
2227 Latch Case Screw Pkg 1-3/4" Door (for devices shipped after October 1998)	900589	-	\$14.00	-

VERTICAL RODS

Description	Specify		Non-Finished	689, 695
	Part number	Finish		
2227 Top Vertical Rod	109361	.[Finish]	-	\$115.00
2227 Bottom Vertical Rod	109362	.[Finish]	-	\$115.00
2227 Extension Rod 36" Kit	051804	.[Finish]	-	\$31.00
2227 Rod Guide Package	112063	.[Finish]	-	\$57.00
2227 Rod Guide Mtg. Package	900919	.[Finish]	-	\$14.00
2227 Rod Connector - Latch Pkg/2	090067	-	\$22.00	-
2227 Rod Connector - Center Case Pkg/2	090068	-	\$22.00	-
2227 Top or Bottom Rod Connector	050547	-	\$12.00	-
2227 Rod Extension Connector Pkg/4	090075	-	\$15.00	-
2227 Rod Roll Pin Pkg/10	090054	-	\$15.00	-

33A/35A SERIES

605	606	611	612	613	619	622	625	626	626AM	628	629
US3	US4	US9	US10	US10B	US15	US19	US26	US26D	US26DAM	US28	US32
630	630AM	643e	689	691	693	695	706	710	711	721	728
US32D	US32DAM	-	SP28	SP10	SPBLK	SP313	SP4	313	315	US3A	US4A

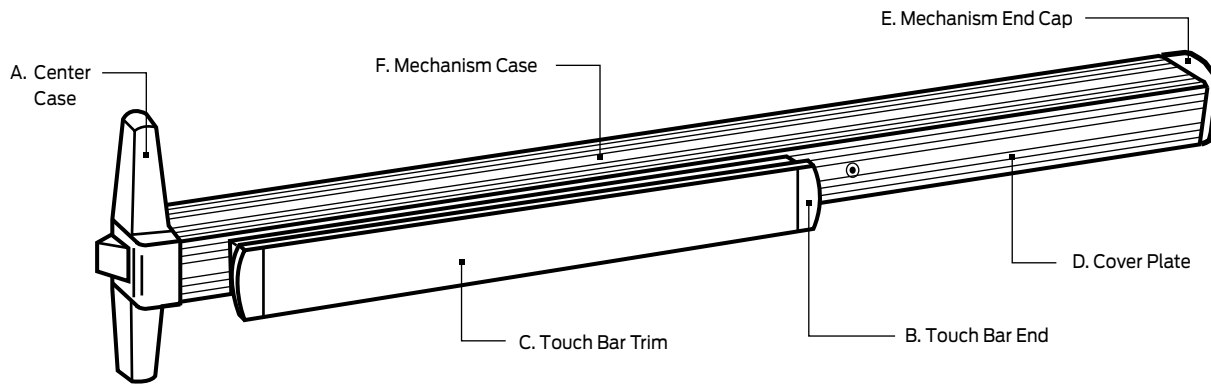

STANDARD FINISHES					
COLOR	US NUMBER	BHMA NUMBER	A, B, E	C - TOUCH BAR TRIM FINISHES	D, F
Bright Brass	US3	605	(A) Buffed Anodized (Dull) (B, E) Bright Brass	Bright Brass, 605 (US3)	Buffed Anodized
Satin Brass	US4	606	(A) Anodized (B, E) Bright Brass	Satin Brass, 606 (US4)	Anodized
Satin Bronze	US10	612	Plated/Anodized	Satin Bronze, 725 (US10)	Anodized
Satin Bronze, Oil-Rubbed	US10B	613	(A) Powder Coat (B, E) Oil-Rubbed	Oil Rubbed, 613 (US10B)	Powder Coat
Satin Nickel	US15	619	Plated, Clear Powder Coat	Satin Stainless Steel, 630 (US32D)	Anodized
Polished Chrome	US26	625	Plated	Bright Stainless Steel, 629 (US32)	Buffed Anodized
Satin Chrome	US26D	626	Plated	Satin Stainless Steel, 630 (US32D)	Anodized
Satin Chrome, Antimicrobial	US26D-AM	626AM	AM Clear over Chrome	AM Clear over Satin Stainless Steel, 630 (US32D)	AM Clear over Anodized
Anodized Aluminum	US28	628	(A, B) Anodized (E) Plated	Satin Stainless Steel, 630 (US32D)	Anodized
Duranodic Dark Bronze	313	710	Powder Coat	Powder Coat, 710 (313)	Powder Coat
Black	315	711	Powder Coat	Powder Coat, 711 (315)	Powder Coat
Aged Bronze	--	643E	(A) Aged Bronze, No Relief (B, E) Relieved Aged Bronze	Relieved Aged Bronze	Aged Bronze No Relief

619 available on 35A only

SPECIAL FINISHES					
COLOR	US NUMBER	BHMA NUMBER	A, B, E	C - TOUCH BAR TRIM FINISHES	D, F
Bright Bronze	US9	611	Plated	Bright Bronze, 611 (US9)	Buffed Anodized
Powder Coat	RAL # *	--	Powder Coat	Powder Coat	Powder Coat

* See Finish page for optional RAL color information.

33A/35A SERIES SEX BOLT QUANTITIES		
APPLICATION	425 SEX BOLTS (SUPPLIED)	FOR LATCHES 325 SEX BOLTS (SUPPLIED)
EO (exit only device)	2	4
DT device with 550 trim	2	4
NLOP device with 388 trim	2	4
3327A or 3347A TLOP with 374T trim	2	2

 Indicates products that have EPD documentation available and meet LEED v4.

33A/35A SERIES

605	606	611	612	613	619	622	625	626	626AM	628	629
US3	US4	US9	US10	US10B	US15	US19	US26	US26D	US26DAM	US28	US32
630	630AM	643e	689	691	693	695	706	710	711	721	728
US32D	US32DAM	-	SP28	SP10	SPBLK	SP313	SP4	313	315	US3A	US4A

TYPE OF DEVICE 33A (GROOVED) 35A (SMOOTH)			
33A or 35A Rim	3327A or 3527A Surface Vertical Rod	3347A/48A or 3547A/48A Concealed Vertical Rod	3349A or 3549A Concealed Vertical Cable
3350WDC or 3550WDC Wood Door Concealed Vertical Cable			

FUNCTION			
DT: Dummy Trim	EO: Exit Only	L: Lever, 06 Standard	LBE: Lever, Blank Escutcheon
LDT: Lever, Dummy Trim	NL: Night Latch, Key Retracts	NLOP: Night Latch, Opt. Pull	T: Thumbturn
TBE: Thumbturn - Blank Escutcheon	TL: Turn Lever	TLBE: Turn Lever, Blank Escutcheon	TLOP: Turn Lever, Opt. Pull







RATING	
None: Panic Exit Device	F: Fire Exit Device

DEVICE FINISH			
605: Bright Brass (US3)	606: Satin Brass (US4)	612: Satin Bronze (US10)	613: Satin Bronze-Oil Rubbed (US10B)
619: Satin Nickel (35A Series only, US15)	625: Bright Chrome (US26)	626: Satin Chrome (US26D)	626AM: Antimicrobial (US26D-AM)
628: Anodized Aluminum (US28)	710: Duranodic Dark Bronze (313)	711: Black (315)	

DEVICE SIZE (FEET AND INCHES)		
2ft: 2' Device for 2' Door - Vertical Device only	3ft: 3' Device for 2' 4" - 3' Door	4ft: 4' Device for 2' 10" - 4' Door

DEVICE HANDING	
RHR: Right Hand Reverse	LHR: Left Hand Reverse

TRIM / CONTROL TRIM			
LC: Less Control	LT: Less Trim	360: Lever Control	360T: Thumbturn Control - Rim
374T: Thumbturn Control - SV	376T: Thumbturn Control - CV	376TWDC: 376T for Wood Door	386: Standard DT/NL Trim
388: Night Latch Cylinder Trim	392-6: Optional Wire Pull Dummy Trim	550: Optional Offset Dummy Trim	E360: 360 Elec. Unlocking
E360T: 360T Elec. Unlocking	E374T: 374T Elec. Unlocking	E376T: 376T Elec. Unlocking	E376TWDC: 376TWDC Elec. Unlocking

CONTROL LEVER STYLES 06 LEVER STANDARD											
Standard levers:	01	02	03	05	06	07	12	16	17	18	
	ACC: Accent 		AST: Asti 		MER: Merano 		LAT: Latitude		LON: Longitude		
Knurled levers:	03K	06K									
M Collection lever:	M51	M52	M53	M54	M55	M56	M61 	M63 			
	M81	M82	M83	M84	M85 	ME1	ME2	ME3			
Stainless steel levers:	03SS	06SS	17SS	LATSS	M57	M62 					

TRIM/CONTROL FINISH			
605: Bright Brass (US3)	606: Satin Brass (US4)	612: Satin Bronze (US10)	613: Satin Bronze-Oil Rubbed (US10B)
625: Bright Chrome(US26)	626: Satin Chrome (US26D)	626AM: Antimicrobial (US26D-AM)	693: Painted Black (SPBLK)

33A/35A SERIES

605	606	611	612	613	619	622	625	626	626AM	628	629
US3	US4	US9	US10	US10B	US15	US19	US26	US26D	US26DAM	US28	US32
630	630AM	643e	689	691	693	695	706	710	711	721	728
US32D	US32DAM	-	SP28	SP10	SPBLK	SP313	SP4	313	315	US3A	US4A

RODS FOR SURFACE / CONCEALED VERTICAL DEVICES ONLY

LBR: Less Bottom Rod LBRAFL: LBR with Aux. Fire Pin OPR: 1 Piece Top Rod

DOGGING OPTIONS

CD: Cylinder Dogging, Panic Only CDSI: Cylinder Dogging with Indicator HD: Hex Dogging HDSI: Hex Dogging with Indicator

LD: Less Dogging

SWITCH OPTIONS

LX: Latchbolt Monitoring LXLC: LBM Low Current LXRX: LBM Request to Exit LXRXC: LBM Request to Exit Low Current

RX: Request to Exit RX2: Request to Exit Double Switch RXLC: Request to Exit Low Current SS: Signal Switch

WPRX: Waterproof Request to Exit

LATCH RETRACTION OPTIONS

EL: Electric Latch Retraction HD-EL: Electric latch retraction (panic only) HD-QEL: Quiet electric latch retraction with hex dogging (panic only) HD-QELX: Quiet electric latch retraction with hex dogging (panic only) for AX devices

PN: Pneumatic Latch Retraction QELA: Quiet Electric Latch Retraction QELX: Quiet electric latch retraction for AX devices

QUIET MECHANICAL - CONTROLS MOTION TO REDUCE OPERATIONAL NOISE

QM33/35A Rim QM33/3527A Surface Vertical Rod

CX DELAYED EGRESS

CX: Chexit - Controlled Exit CXRCM: Remote Chexit Module

ELECTRICAL LOCKING

ES: Pullman Latch for Electric Strike FS: Fail Safe FSE: Fail Secure

STORM RATING

HH: Hurricane device

ACCESSIBLE DEVICE

AX: Accessible device compliant with the California Building Code (Section 11B-309.4) requirement for 5 lb. maximum operational force.

STRIKE SERIES

LS: Less Strike	LTS: Less Top Strike	1410: Optional Rim	1439: Standard Rim
1439F: Optional Rim Fire	150: Standard CVC-WDC	1606: Optional Rim	1609: Optional Rim
249: Standard CVC	260U: Optional SV Flush Transom	260UF: Option SV Fire Flush Transom	264: Optional Rim or SV
266: Standard SV	283: Optional CV - Wood Frame	299: Optional Rim	299F: Standard SV Fire
338: Standard CV	499F: Standard SV Fire LBR		

605	606	611	612	613	619	622	625	626	626AM	628	629
US3	US4	US9	US10	US10B	US15	US19	US26	US26D	US26DAM	US28	US32
630	630AM	643e	689	691	693	695	706	710	711	721	728
US32D	US32DAM	-	SP28	SP10	SPBLK	SP313	SP4	313	315	US3A	US4A

BOTTOM STRIKE SERIES

LBS: Less Bottom Strike	248L4: Surface	304L: Mortise	349: Standard CVC
385A: Adjustable Mortise	450: Standard CVC-WDC		

ELECTRIC / MONITOR STRIKE

OTH: Other Mfg Strike	4263T1: Rim monitor strike	4263T1: Rim monitor strike	4690-1T2: for 33/3547A Non - Fire
4690T2: for 33/3547A-F	6111: Rim with Mullion 33/3527A LBR	6112: 33/35A Rim single door	6113: 33/35A Rim single door
6114: 33/35A Rim NL function	6121: 33/35A Rim double door no mullion	6213: Used with 33/3547A LBR	

STRIKE FINISH

605: Bright Brass (US3)	606: Satin Brass (US4)	612: Satin Bronze (US10)	613: Satin Bronze-Oil Rubbed (US10B)
625: Bright Chrome(US26)	626: Satin Chrome (US26D)	629: Bright Stainless (US32)	630: Satin Stainless (US32D)
691: Satin Bronze (SP10)	695: Duranodic Dark Bronze (313)	711: Flat Black (US19)	

TOUCH BAR TRIM OPTIONS

BR: Braille	EMB: Embossed "Push"	KN: Knurled	RSS: Emergency Exit (630 only)
SG: Safety Glow			

DRAINAGE / WEEP HOLES

WH: Drainage/Weep Holes in Mechanism Case (3' device will have 5 holes, 6" spacing; 4' device will have 7 holes, 6" spacing)

CX DELAYED EGRESS RELEASE DELAY

OSEC: 0 second delay	15SEC: 15 second delay	INFDEL: Infinite delay	M15SEC: 15 second mute delay
BOCA15SEC: BOCA 15 second delay	BOCA30SEC: BOCA 30 second delay		

MISC DEVICE OPTIONS

CE: CE Label	10WDA: WDA cover plate	33AWDA: 33A WDA cover plate	50WDC: 50WDC cover plate
ALK: Standard Alarm Kit	CYL: Include Cylinder	LCP: Less cover plate	PL: Include Pullman Latch

CONNECTOR

CON: Connectors

SECURITY SCREWS

SEC: Include Security Screws

GBK/SHIM KIT/RISES

GBK: Include GBK

DOOR THICKNESS

DT1-3/4: 1-3/4" Standard	DT2: 2" thickness	DT2-1/4: 2-1/4" thickness
--------------------------	-------------------	---------------------------

605	606	611	612	613	619	622	625	626	626AM	628	629
US3	US4	US9	US10	US10B	US15	US19	US26	US26D	US26DAM	US28	US32
630	630AM	643e	689	691	693	695	706	710	711	721	728
US32D	US32DAM	-	SP28	SP10	SPBLK	SP313	SP4	313	315	US3A	US4A

DOOR MATERIAL

ALD: Aluminum door	CP: Composite door	HMD: Hollow metal	WD: Wood door
INS2: Insulclad - 1/2"	INS4: Insulclad - 1/4"		

FRAME MATERIAL

ALF: Aluminum Frame	HMF: Hollow Metal Frame	WDF: Wood Frame
---------------------	-------------------------	-----------------

DOOR MODE/APPLICATION

DE: Pair Double egress doors	PR: Pair of doors	SGL: Single door
------------------------------	-------------------	------------------

MULLION APPLICATION

1654: Hollow metal (HM) used with 2 - 1606 strikes	4754: Hollow metal (HM) used with 2 - 4263 monitor strikes	5654: Aluminum (AL) used with 2 - 299 strikes
4954: Hollow metal (HM) used with 2 - 299/264 strikes	4854: Hollow metal (HM) used with a 299 and 611ES	5754: Aluminum (AL) 1408 strike installed

APPLICATION NOTE FOR 2' DEVICE

Available on Surface and Concealed Vertical (panic and fire).

When vertical rod devices are used on both doors of a pair, operation of the inactive door (smaller door) will not disengage the active door, creating a potential safety issue for those using the inactive door during an emergency. In addition, standard hex or cylinder dogging is not available. Dogging is not available for this application on 33/3527A/47/49A/50A-WDC devices.

For pairs of doors using one 2' door Von Duprin recommends the following hardware combinations listed below for optimum safety in an emergency.

1. Surface or Concealed Vertical device on the 2' door (inactive) and a mortise device on the larger door (active). This combination is used primarily on Hollow Metal door applications only.
2. Automatic Flush Bolt on the 2' door (inactive) and a Surface or Concealed Vertical device on the larger door (active).

Note: The 2' door width is not available with any electrical, Chexit, hurricane or windstorm options.

33A/35A SERIES

605	606	611	612	613	619	622	625	626	626AM	628	629
US3	US4	US9	US10	US10B	US15	US19	US26	US26D	US26DAM	US28	US32
630	630AM	643e	689	691	693	695	706	710	711	721	728
US32D	US32DAM	-	SP28	SPIO	SPBLK	SP313	SP4	313	315	US3A	US4A

Rim devices

ACN							PRICE BASED ON FINISH							Default trim, included						
Device type	Function	Fire	Finish	Device size	Handing	Lever design	626	628	710	612	606 [Ⓜ]	605 [Ⓜ] 619 ¹ 625 643E	711		613 ²					
							3' DEVICE PRICING SHOWN. 2' ADD \$78.00 LIST, 4' ADD \$19.00 LIST													
EXIT HARDWARE							3' DEVICE PRICING SHOWN. 2' ADD \$78.00 LIST, 4' ADD \$19.00 LIST													
[33A/35A]	EO	.	[]	.	[]		\$1,831	\$1,493	\$1,498	\$1,546	\$1,546	\$1,916	\$2,292	\$1,808	N/A					
[33A/35A]	DT	.	[]	.	[]		\$2,200	\$1,862	\$1,867	\$2,063	\$1,915	\$2,376	\$2,661	\$2,177	386DT					
[33A/35A]	NL	.	[]	.	[]	[]	\$2,487	\$2,149	\$2,154	\$2,350	\$2,202	\$2,663	\$2,948	\$2,464	386NL [Ⓜ]					
[33A/35A]	NL-OP	.	[]	.	[]		\$2,154	\$1,816	\$1,821	\$2,011	\$1,848	\$2,239	\$2,615	\$2,131	388					
[33A/35A]	L	.	[]	.	[]	[]	\$2,552	\$2,214	\$2,241	\$2,322	\$2,236	\$2,719	\$3,035	\$2,551	360L ³					
[33A/35A]	L-BE	.	[]	.	[]	[]	\$2,506	\$2,168	\$2,195	\$2,276	\$2,190	\$2,673	\$2,989	\$2,505	360L-BE ³					
[33A/35A]	L-DT	.	[]	.	[]	[]	\$2,497	\$2,159	\$2,186	\$2,267	\$2,181	\$2,664	\$2,980	\$2,496	360L-DT ³					
[33A/35A]	TL	.	[]	.	[]		\$2,613	\$2,275	\$2,280	\$2,388	\$2,220	\$2,758	\$3,074	\$2,590	360T ³					
[33A/35A]	TL-BE	.	[]	.	[]		\$2,570	\$2,232	\$2,237	\$2,345	\$2,177	\$2,715	\$3,031	\$2,547	360T-BE ³					
[33A/35A]	T	.	[]	.	[]		\$2,613	\$2,275	\$2,280	\$2,388	\$2,220	\$2,758	\$3,074	\$2,590	360T ³					
[33A/35A]	T-BE	.	[]	.	[]		\$2,570	\$2,232	\$2,237	\$2,345	\$2,177	\$2,715	\$3,031	\$2,547	360T-BE ³					
FIRE EXIT HARDWARE							3' DEVICE PRICING SHOWN. 2' ADD \$78.00 LIST, 4' ADD \$19.00 LIST													
[33A/35A]	EO	.	F	.	[]	[]	\$1,858	\$1,520	\$1,525	\$1,573	\$1,573	\$1,943	\$2,319	\$1,835	N/A					
[33A/35A]	DT	.	F	.	[]	[]	\$2,227	\$1,889	\$1,894	\$2,090	\$1,942	\$2,403	\$2,688	\$2,204	386DT					
[33A/35A]	NL	.	F	.	[]	[]	\$2,514	\$2,176	\$2,181	\$2,377	\$2,229	\$2,690	\$2,975	\$2,491	386NL [Ⓜ]					
[33A/35A]	NL-OP	.	F	.	[]	[]	\$2,181	\$1,843	\$1,848	\$2,038	\$1,875	\$2,266	\$2,642	\$2,158	388					
[33A/35A]	L	.	F	.	[]	[]	\$2,579	\$2,241	\$2,268	\$2,349	\$2,263	\$2,746	\$3,062	\$2,578	360L ³					
[33A/35A]	L-BE	.	F	.	[]	[]	\$2,533	\$2,195	\$2,222	\$2,303	\$2,217	\$2,700	\$3,016	\$2,532	360L-BE ³					
[33A/35A]	TL	.	F	.	[]	[]	\$2,640	\$2,302	\$2,307	\$2,415	\$2,247	\$2,785	\$3,101	\$2,617	360T ³					
[33A/35A]	TL-BE	.	F	.	[]	[]	\$2,597	\$2,259	\$2,264	\$2,372	\$2,204	\$2,742	\$3,058	\$2,574	360T-BE ³					
[33A/35A]	T	.	F	.	[]	[]	\$2,640	\$2,302	\$2,307	\$2,415	\$2,247	\$2,785	\$3,101	\$2,617	360T ³					
[33A/35A]	T-BE	.	F	.	[]	[]	\$2,597	\$2,259	\$2,264	\$2,372	\$2,204	\$2,742	\$3,058	\$2,574	360T-BE ³					

[Ⓜ] Consult factory for lead time

[Ⓜ] 386NL Series trim is handed and not field reversible. Please specify handing, RHR or LHR.

¹ 619 finish available only on 35A Series

² 613 finish has 710 finish device with 613 parts

³ Wood Doors - 33A-WDA cover plate is required for the 360 series control and will be supplied at an additional, \$56 list add.

DEFAULT ATTRIBUTES

Pricing includes default options shown below. Additional options and configurations available.

Cylinders:	Sex bolts	Door thickness	Center line
Not included	Included	1-3/4"	39-13/16"

Strike(s):

Exit hardware:

- ALF applications: Includes 1439 strike
- HMF and WDF applications: 299 strike is supplied at a \$91 list deduct

Fire exit hardware:

- Single door applications: Includes 299F strike
- Double door applications: 499F strike will be supplied at an additional \$112 list add

605	606	611	612	613	619	622	625	626	626AM	628	629
US3	US4	US9	US10	US10B	US15	US19	US26	US26D	US26DAM	US28	US32
630	630AM	643e	689	691	693	695	706	710	711	721	728
US32D	US32DAM	-	SP28	SP10	SPBLK	SP313	SP4	313	315	US3A	US4A

33A/35A SERIES

Surface vertical rod devices (27A)

ACN							PRICE BASED ON FINISH						Default trim, included		
Device type	Function	Fire	Finish	Device size	Handing	Lever design	626	628	710	612	606 ²	605 ² 619 ¹ 625 643E		711	613 ²
EXIT HARDWARE							3' DEVICE PRICING SHOWN. 2' ADD \$78.00 LIST, 4' ADD \$19.00 LIST								
[33/35]27A	EO	.	[] . []	.			\$2,598	\$2,204	\$2,248	\$2,300	\$2,297	\$2,692	\$3,163	\$2,737	N/A
[33/35]27A	DT	.	[] . []	.			\$2,967	\$2,573	\$2,617	\$2,817	\$2,666	\$3,152	\$3,532	\$3,106	386DT
[33/35]27A	NL	.	[] . []	.	[]		\$3,254	\$2,860	\$2,904	\$3,104	\$2,953	\$3,439	\$3,819	\$3,393	386NL ³
[33/35]27A	NL-OP	.	[] . []	.			\$2,921	\$2,527	\$2,571	\$2,765	\$2,599	\$3,015	\$3,486	\$3,060	388
[33/35]27A	L	.	[] . []	.	[] . []		\$3,319	\$2,925	\$2,991	\$3,076	\$2,987	\$3,495	\$3,906	\$3,480	360L ³
[33/35]27A	L-BE	.	[] . []	.	[] . []		\$3,273	\$2,879	\$2,945	\$3,030	\$2,941	\$3,449	\$3,860	\$3,434	360L-BE ³
[33/35]27A	L-DT	.	[] . []	.	[] . []		\$3,264	\$2,870	\$2,936	\$3,021	\$2,932	\$3,440	\$3,851	\$3,425	360L-DT ³
[33/35]27A	TL	.	[] . []	.			\$3,749	\$3,355	\$3,399	\$3,659	\$3,340	\$3,994	\$4,314	\$3,888	360T ³
[33/35]27A	TL-BE	.	[] . []	.			\$3,706	\$3,312	\$3,356	\$3,616	\$3,297	\$3,951	\$4,271	\$3,845	360T-BE ³
[33/35]27A	T	.	[] . []	.			\$3,380	\$2,986	\$3,030	\$3,142	\$2,971	\$3,534	\$3,945	\$3,519	360T ³
[33/35]27A	T-BE	.	[] . []	.			\$3,337	\$2,943	\$2,987	\$3,099	\$2,928	\$3,491	\$3,902	\$3,476	360T-BE ³
FIRE EXIT HARDWARE							3' DEVICE PRICING SHOWN. 2' ADD \$78.00 LIST, 4' ADD \$19.00 LIST								
[33/35]27A	EO	. F	[] . []	.			\$2,625	\$2,231	\$2,275	\$2,327	\$2,324	\$2,719	\$3,190	\$2,764	N/A
[33/35]27A	DT	. F	[] . []	.			\$2,994	\$2,600	\$2,644	\$2,844	\$2,693	\$3,179	\$3,559	\$3,133	386DT
[33/35]27A	NL	. F	[] . []	.	[]		\$3,281	\$2,887	\$2,931	\$3,131	\$2,980	\$3,466	\$3,846	\$3,420	386NL ³
[33/35]27A	NL-OP	. F	[] . []	.			\$2,948	\$2,554	\$2,598	\$2,792	\$2,626	\$3,042	\$3,513	\$3,087	388
[33/35]27A	L	. F	[] . []	.	[] . []		\$3,346	\$2,952	\$3,018	\$3,103	\$3,014	\$3,522	\$3,933	\$3,507	360L ³
[33/35]27A	L-BE	. F	[] . []	.	[] . []		\$3,300	\$2,906	\$2,972	\$3,057	\$2,968	\$3,476	\$3,887	\$3,461	360L-BE ³
[33/35]27A	TL	. F	[] . []	.			\$3,776	\$3,382	\$3,426	\$3,686	\$3,367	\$4,021	\$4,341	\$3,915	360T ³
[33/35]27A	TL-BE	. F	[] . []	.			\$3,733	\$3,339	\$3,383	\$3,643	\$3,324	\$3,978	\$4,298	\$3,872	360T-BE ³
[33/35]27A	T	. F	[] . []	.			\$3,407	\$3,013	\$3,057	\$3,169	\$2,998	\$3,561	\$3,972	\$3,546	360T ³
[33/35]27A	T-BE	. F	[] . []	.			\$3,364	\$2,970	\$3,014	\$3,126	\$2,955	\$3,518	\$3,929	\$3,503	360T-BE ³

☒ Consult factory for lead time

☞ 386NL Series trim is handed and not field reversible. Please specify handing, RHR or LHR.

¹ 619 finish available only on 35A Series

² 613 finish has 710 finish device with 613 parts

³ Wood Doors - 33A-WDA cover plate is required for the 360 series control and will be supplied at an additional, \$56 list add.

DEFAULT ATTRIBUTES

Pricing includes default options shown below. Additional options and configurations available.

Cylinders:	Sex bolts	Door thickness	Center line
Not included	Included	1-3/4"	39-13/16"

Strike(s):

Exit hardware:

- Includes 266, 248L-4 and 304L strikes

Fire exit hardware:

- Includes 299F and 304L strikes

33A/35A SERIES

605	606	611	612	613	619	622	625	626	626AM	628	629
US3	US4	US9	US10	US10B	US15	US19	US26	US26D	US26DAM	US28	US32
630	630AM	643e	689	691	693	695	706	710	711	721	728
US32D	US32DAM	-	SP28	SP10	SPBLK	SP313	SP4	313	315	US3A	US4A

Concealed vertical rod devices (47A)

ACN							PRICE BASED ON FINISH						Default trim, included		
Device type	Function	Fire	Finish	Device size	Handing	Lever design	626	628	710	612	606 ²	605 ² 619 ¹ 625 643E		711	613 ²
EXIT HARDWARE							3' DEVICE PRICING SHOWN. 2' ADD \$78.00 LIST, 4' ADD \$19.00 LIST								
[33/35]47A	EO		[] . [] .				\$2,591	\$2,197	\$2,241	\$2,293	\$2,290	\$2,685	\$3,156	\$2,730	N/A
[33/35]47A	DT		[] . [] .				\$2,960	\$2,566	\$2,610	\$2,810	\$2,659	\$3,145	\$3,525	\$3,099	386DT
[33/35]47A	NL		[] . [] . []				\$3,247	\$2,853	\$2,897	\$3,097	\$2,946	\$3,432	\$3,812	\$3,386	386NL ³
[33/35]47A	NL-OP		[] . [] .				\$2,914	\$2,520	\$2,564	\$2,758	\$2,592	\$3,008	\$3,479	\$3,053	388
[33/35]47A	L		[] . [] . [] . []				\$3,312	\$2,918	\$2,984	\$3,069	\$2,980	\$3,488	\$3,899	\$3,473	360L ³
[33/35]47A	L-BE		[] . [] . [] . []				\$3,266	\$2,872	\$2,938	\$3,023	\$2,934	\$3,442	\$3,853	\$3,427	360L-BE ³
[33/35]47A	L-DT		[] . [] . [] . []				\$3,257	\$2,863	\$2,929	\$3,014	\$2,925	\$3,433	\$3,844	\$3,418	360L-DT ³
[33/35]47A	TL		[] . [] .				\$3,742	\$3,348	\$3,392	\$3,652	\$3,333	\$3,987	\$4,307	\$3,881	360T ³
[33/35]47A	TL-BE		[] . [] .				\$3,699	\$3,305	\$3,349	\$3,609	\$3,290	\$3,944	\$4,264	\$3,838	360T-BE ³
[33/35]47A	T		[] . [] .				\$3,373	\$2,979	\$3,023	\$3,135	\$2,964	\$3,527	\$3,938	\$3,512	360T ³
[33/35]47A	T-BE		[] . [] .				\$3,330	\$2,936	\$2,980	\$3,092	\$2,921	\$3,484	\$3,895	\$3,469	360T-BE ³
FIRE EXIT HARDWARE							3' DEVICE PRICING SHOWN. 2' ADD \$78.00 LIST, 4' ADD \$19.00 LIST								
[33/35]47A	EO	F	[] . []				\$2,735	\$2,341	\$2,385	\$2,437	\$2,434	\$2,829	\$3,300	\$2,874	N/A
[33/35]47A	DT	F	[] . []				\$3,104	\$2,710	\$2,754	\$2,954	\$2,803	\$3,289	\$3,669	\$3,243	386DT
[33/35]47A	NL	F	[] . [] . []				\$3,391	\$2,997	\$3,041	\$3,241	\$3,090	\$3,576	\$3,956	\$3,530	386NL ³
[33/35]47A	NL-OP	F	[] . []				\$3,058	\$2,664	\$2,708	\$2,902	\$2,736	\$3,152	\$3,623	\$3,197	388
[33/35]47A	L	F	[] . [] . [] . []				\$3,456	\$3,062	\$3,128	\$3,213	\$3,124	\$3,632	\$4,043	\$3,617	360L ³
[33/35]47A	L-BE	F	[] . [] . [] . []				\$3,410	\$3,016	\$3,082	\$3,167	\$3,078	\$3,586	\$3,997	\$3,571	360L-BE ³
[33/35]47A	TL	F	[] . []				\$3,886	\$3,492	\$3,536	\$3,796	\$3,477	\$4,131	\$4,451	\$4,025	360T ³
[33/35]47A	TL-BE	F	[] . []				\$3,843	\$3,449	\$3,493	\$3,753	\$3,434	\$4,088	\$4,408	\$3,982	360T-BE ³
[33/35]47A	T	F	[] . []				\$3,517	\$3,123	\$3,167	\$3,279	\$3,108	\$3,671	\$4,082	\$3,656	360T ³
[33/35]47A	T-BE	F	[] . []				\$3,474	\$3,080	\$3,124	\$3,236	\$3,065	\$3,628	\$4,039	\$3,613	360T-BE ³

² Consult factory for lead time

³ 386NL Series trim is handed and not field reversible. Please specify handing, RHR or LHR.

¹ 619 finish available only on 35A Series

² 613 finish has 710 finish device with 613 parts

³ Wood Doors - 33A-WDA cover plate is required for the 360 series control and will be supplied at an additional, \$56 list add.

DEFAULT ATTRIBUTES

Pricing includes default options shown below. Additional options and configurations available.

Cylinders:	Sex bolts	Door thickness	Center line
Not included	Included	1-3/4"	39-13/16"

Strike(s):

Exit hardware:

- Includes 338 and 385A strikes

Fire exit hardware:

- Includes 338 and 385A strikes

33A/35A SERIES

605	606	611	612	613	619	622	625	626	626AM	628	629
US3	US4	US9	US10	US10B	US15	US19	US26	US26D	US26DAM	US28	US32
630	630AM	643e	689	691	693	695	706	710	711	721	728
US32D	US32DAM	-	SP28	SPI0	SPBLK	SP313	SP4	313	315	US3A	US4A

Concealed vertical rod devices for hollow metal doors (48A)

ACN							PRICE BASED ON FINISH						Default trim, included		
Device type	Function	Fire	Finish	Device size	Handing	Lever design	626	628	710	612	606 ²	605 ² 619 ¹ 625 643E		711	613 ²
EXIT HARDWARE							3' DEVICE PRICING SHOWN. 2' ADD \$78.00 LIST, 4' ADD \$19.00 LIST								
[33/35]48A	EO		[] . [] .				\$2,902	\$2,508	\$2,552	\$2,604	\$2,601	\$2,996	\$3,467	\$3,041	N/A
[33/35]48A	DT		[] . [] .				\$3,271	\$2,877	\$2,921	\$3,121	\$2,970	\$3,456	\$3,836	\$3,410	386DT
[33/35]48A	NL		[] . [] . []				\$3,558	\$3,164	\$3,208	\$3,408	\$3,257	\$3,743	\$4,123	\$3,697	386NL ³
[33/35]48A	NL-OP		[] . [] .				\$3,225	\$2,831	\$2,875	\$3,069	\$2,903	\$3,319	\$3,790	\$3,364	388
[33/35]48A	L		[] . [] . [] . []				\$3,623	\$3,229	\$3,295	\$3,380	\$3,291	\$3,799	\$4,210	\$3,784	360L
[33/35]48A	L-BE		[] . [] . [] . []				\$3,577	\$3,183	\$3,249	\$3,334	\$3,245	\$3,753	\$4,164	\$3,738	360L-BE
[33/35]48A	L-DT		[] . [] . [] . []				\$3,568	\$3,174	\$3,240	\$3,325	\$3,236	\$3,744	\$4,155	\$3,729	360L-DT
[33/35]48A	TL		[] . [] .				\$4,053	\$3,659	\$3,703	\$3,963	\$3,644	\$4,298	\$4,618	\$4,192	360T
[33/35]48A	TL-BE		[] . [] .				\$4,010	\$3,616	\$3,660	\$3,920	\$3,601	\$4,255	\$4,575	\$4,149	360T-BE
[33/35]48A	T		[] . [] .				\$3,684	\$3,290	\$3,334	\$3,446	\$3,275	\$3,838	\$4,249	\$3,823	360T
[33/35]48A	T-BE		[] . [] .				\$3,641	\$3,247	\$3,291	\$3,403	\$3,232	\$3,795	\$4,206	\$3,780	360T-BE
FIRE EXIT HARDWARE							3' DEVICE PRICING SHOWN. 2' ADD \$78.00 LIST, 4' ADD \$19.00 LIST								
[33/35]48A	EO	F	[] . []				\$3,040	\$2,646	\$2,690	\$2,742	\$2,739	\$3,134	\$3,605	\$3,179	N/A
[33/35]48A	DT	F	[] . []				\$3,409	\$3,015	\$3,059	\$3,259	\$3,108	\$3,594	\$3,974	\$3,548	386DT
[33/35]48A	NL	F	[] . [] . []				\$3,696	\$3,302	\$3,346	\$3,546	\$3,395	\$3,881	\$4,261	\$3,835	386NL ³
[33/35]48A	NL-OP	F	[] . []				\$3,363	\$2,969	\$3,013	\$3,207	\$3,041	\$3,457	\$3,928	\$3,502	388
[33/35]48A	L	F	[] . [] . [] . []				\$3,761	\$3,367	\$3,433	\$3,518	\$3,429	\$3,937	\$4,348	\$3,922	360L
[33/35]48A	L-BE	F	[] . [] . [] . []				\$3,715	\$3,321	\$3,387	\$3,472	\$3,383	\$3,891	\$4,302	\$3,876	360L-BE
[33/35]48A	L-DT	F	[] . [] . [] . []				\$3,706	\$3,312	\$3,378	\$3,463	\$3,374	\$3,882	\$4,293	\$3,867	360L-DT
[33/35]48A	TL	F	[] . []				\$4,191	\$3,797	\$3,841	\$4,101	\$3,782	\$4,436	\$4,756	\$4,330	360T
[33/35]48A	TL-BE	F	[] . []				\$4,148	\$3,754	\$3,798	\$4,058	\$3,739	\$4,393	\$4,713	\$4,287	360T-BE
[33/35]48A	T	F	[] . []				\$3,822	\$3,428	\$3,472	\$3,584	\$3,413	\$3,976	\$4,387	\$3,961	360T
[33/35]48A	T-BE	F	[] . []				\$3,779	\$3,385	\$3,429	\$3,541	\$3,370	\$3,933	\$4,344	\$3,918	360T-BE

² Consult factory for lead time

³ 386NL Series trim is handed and not field reversible. Please specify handing, RHR or LHR.

¹ 619 finish available only on 35A Series

² 613 finish has 710 finish device with 613 parts

DEFAULT ATTRIBUTES

Pricing includes default options shown below. Additional options and configurations available.

Cylinders:	Sex bolts	Door thickness	Center line
Not included	Included	1-3/4"	39-13/16"

Strike(s):

Exit hardware:

- Includes 338 and 385A strikes

Fire exit hardware:

- Includes 338 and 385A strikes

33A/35A SERIES

605	606	611	612	613	619	622	625	626	626AM	628	629
US3	US4	US9	US10	US10B	US15	US19	US26	US26D	US26DAM	US28	US32
630	630AM	643e	689	691	693	695	706	710	711	721	728
US32D	US32DAM	-	SP28	SP10	SPBLK	SP313	SP4	313	315	US3A	US4A

Concealed vertical rod devices for hollow metal doors (49A)

Prices shown are for door opening heights 6'0" -10'0"

ACN							PRICE BASED ON FINISH						Default trim, included		
Device type	Function	Fire	Finish	Device size	Handing	Lever design	626	628	710	612	606 ²	605 ² 619 ¹ 625 643E		711	613 ²
EXIT HARDWARE							3' DEVICE PRICING SHOWN. 2' ADD \$78.00 LIST, 4' ADD \$19.00 LIST								
[33/35]49A	EO		[] . [] .				\$2,602	\$2,208	\$2,252	\$2,304	\$2,301	\$2,696	\$3,167	\$2,741	N/A
[33/35]49A	DT		[] . [] .				\$2,971	\$2,577	\$2,621	\$2,821	\$2,670	\$3,156	\$3,536	\$3,110	386DT
[33/35]49A	NL		[] . [] . []				\$3,258	\$2,864	\$2,908	\$3,108	\$2,957	\$3,443	\$3,823	\$3,397	386NL ³
[33/35]49A	NL-OP		[] . [] .				\$2,925	\$2,531	\$2,575	\$2,769	\$2,603	\$3,019	\$3,490	\$3,064	388
[33/35]49A	L		[] . [] . [] . []				\$3,323	\$2,929	\$2,995	\$3,080	\$2,991	\$3,499	\$3,910	\$3,484	360L
[33/35]49A	L-BE		[] . [] . [] . []				\$3,277	\$2,883	\$2,949	\$3,034	\$2,945	\$3,453	\$3,864	\$3,438	360L-BE
[33/35]49A	L-DT		[] . [] . [] . []				\$3,268	\$2,874	\$2,940	\$3,025	\$2,936	\$3,444	\$3,855	\$3,429	360L-DT
[33/35]49A	T		[] . [] .				\$3,384	\$2,990	\$3,034	\$3,146	\$2,975	\$3,538	\$3,949	\$3,523	360T
[33/35]49A	T-BE		[] . [] .				\$3,341	\$2,947	\$2,991	\$3,103	\$2,932	\$3,495	\$3,906	\$3,480	360T-BE
FIRE EXIT HARDWARE							3' DEVICE PRICING SHOWN. 2' ADD \$78.00 LIST, 4' ADD \$19.00 LIST								
[33/35]49A	EO	F	[] . []				\$2,712	\$2,318	\$2,362	\$2,414	\$2,411	\$2,806	\$3,277	\$2,851	N/A
[33/35]49A	DT	F	[] . []				\$3,081	\$2,687	\$2,731	\$2,931	\$2,780	\$3,266	\$3,646	\$3,220	386DT
[33/35]49A	NL	F	[] . [] . []				\$3,368	\$2,974	\$3,018	\$3,218	\$3,067	\$3,553	\$3,933	\$3,507	386NL ³
[33/35]49A	NL-OP	F	[] . []				\$3,035	\$2,641	\$2,685	\$2,879	\$2,713	\$3,129	\$3,600	\$3,174	388
[33/35]49A	L	F	[] . [] . [] . []				\$3,433	\$3,039	\$3,105	\$3,190	\$3,101	\$3,609	\$4,020	\$3,594	360L
[33/35]49A	L-BE	F	[] . [] . [] . []				\$3,387	\$2,993	\$3,059	\$3,144	\$3,055	\$3,563	\$3,974	\$3,548	360L-BE
[33/35]49A	T	F	[] . []				\$3,494	\$3,100	\$3,144	\$3,256	\$3,085	\$3,648	\$4,059	\$3,633	360T
[33/35]49A	T-BE	F	[] . []				\$3,451	\$3,057	\$3,101	\$3,213	\$3,042	\$3,605	\$4,016	\$3,590	360T-BE

For Devices Less Cable System (LCS) Deduct \$1,036

² Consult factory for lead time

³ 386NL Series trim is handed and not field reversible. Please specify handing, RHR or LHR.

¹ 619 finish available only on 35A Series

² 613 finish has 710 finish device with 613 parts

DEFAULT ATTRIBUTES

Pricing includes default options shown below. Additional options and configurations available.

Cylinders:	Sex bolts	Door thickness	Door opening height
Not included	Included	1-3/4"	6'10' - 8' Specify door opening height if other than 6'10' - 8'.
			For door opening heights more than 10', consult factory

Strike(s):

Exit hardware:

- Includes 249 and 349 Strikes

Fire exit hardware:

- Includes 249 and 349 Strikes

33A/35A SERIES

605	606	611	612	613	619	622	625	626	626AM	628	629
US3	US4	US9	US10	US10B	US15	US19	US26	US26D	US26DAM	US28	US32
630	630AM	643e	689	691	693	695	706	710	711	721	728
US32D	US32DAM	-	SP28	SP10	SPBLK	SP313	SP4	313	315	US3A	US4A

Wood door concealed vertical cable devices (50A-WDC)

Prices shown are for door opening heights 6'0" -10'0"

ACN								PRICE BASED ON FINISH						Default trim, included		
Device type	Function	Fire	Finish	Device size	Door height	Handing	Lever design	626	628	710	612	606 ²	605 ² 619 ¹ 625 643E		711	613 ²
EXIT HARDWARE								3' DEVICE PRICING SHOWN. 2' ADD \$78.00 LIST, 4' ADD \$19.00 LIST								
[33/35]50A-WDC	EO	.	[]	[]	[]	[]		\$2,606	\$2,365	\$2,537	\$2,627	\$2,709	\$2,888	\$3,259	\$3,108	N/A
[33/35]50A-WDC	DT	.	[]	[]	[]	[]		\$2,975	\$2,734	\$2,906	\$3,144	\$3,078	\$3,348	\$3,628	\$3,477	386DT
[33/35]50A-WDC	NL	.	[]	[]	[]	[]	[]	\$3,262	\$3,021	\$3,193	\$3,431	\$3,365	\$3,635	\$3,915	\$3,764	386NL
[33/35]50A-WDC	NL-OP	.	[]	[]	[]	[]		\$2,929	\$2,688	\$2,860	\$3,092	\$3,011	\$3,211	\$3,582	\$3,431	388
[33/35]50A-WDC	L	.	[]	[]	[]	[]	[]	\$3,383	\$3,142	\$3,336	\$3,459	\$3,455	\$3,747	\$4,058	\$3,907	360L/33A-WDA ³
[33/35]50A-WDC	L-BE	.	[]	[]	[]	[]	[]	\$3,337	\$3,096	\$3,290	\$3,413	\$3,409	\$3,701	\$4,012	\$3,861	360L-BE/33A-WDA ³
[33/35]50A-WDC	L-DT	.	[]	[]	[]	[]	[]	\$3,328	\$3,087	\$3,281	\$3,404	\$3,400	\$3,692	\$4,003	\$3,852	360L-DT/33A-WDA ³
[33/35]50A-WDC	T	.	[]	[]	[]	[]		\$3,444	\$3,203	\$3,375	\$3,525	\$3,439	\$3,786	\$4,097	\$3,946	360T/33A-WDA ³
[33/35]50A-WDC	T-BE	.	[]	[]	[]	[]		\$3,401	\$3,160	\$3,332	\$3,482	\$3,396	\$3,743	\$4,054	\$3,903	360T-BE/33A-WDA ³

For Devices Less Cable System (LCS) Deduct \$1,186

FIRE EXIT HARDWARE								3' DEVICE PRICING SHOWN. 2' ADD \$78.00 LIST, 4' ADD \$19.00 LIST								
[33/35]50A-WDC	EO	.	F	[]	[]	[]		\$2,918	\$2,677	\$2,849	\$2,939	\$3,021	\$3,200	\$3,571	\$3,420	N/A
[33/35]50A-WDC	DT	.	F	[]	[]	[]		\$3,287	\$3,046	\$3,218	\$3,456	\$3,390	\$3,660	\$3,940	\$3,789	386DT
[33/35]50A-WDC	NL	.	F	[]	[]	[]	[]	\$3,574	\$3,333	\$3,505	\$3,743	\$3,677	\$3,947	\$4,227	\$4,076	386NL
[33/35]50A-WDC	NL-OP	.	F	[]	[]	[]		\$3,241	\$3,000	\$3,172	\$3,404	\$3,323	\$3,523	\$3,894	\$3,743	388
[33/35]50A-WDC	L	.	F	[]	[]	[]	[]	\$3,695	\$3,454	\$3,648	\$3,771	\$3,767	\$4,059	\$4,370	\$4,219	360L ³
[33/35]50A-WDC	L-BE	.	F	[]	[]	[]	[]	\$3,649	\$3,408	\$3,602	\$3,725	\$3,721	\$4,013	\$4,324	\$4,173	360L-BE ³
[33/35]50A-WDC	T	.	F	[]	[]	[]		\$3,756	\$3,515	\$3,687	\$3,837	\$3,751	\$4,098	\$4,409	\$4,258	360T ³
[33/35]50A-WDC	T-BE	.	F	[]	[]	[]		\$3,713	\$3,472	\$3,644	\$3,794	\$3,708	\$4,055	\$4,366	\$4,215	360T-BE ³

For Devices Less Cable System (LCS) Deduct \$1,498

² Consult factory for lead time

³ 386NL Series trim is handed and not field reversible. Please specify handing, RHR or LHR.

¹ 619 finish available only on 35A Series

² 613 finish has 710 finish device with 613 parts

Door opening height - must be specified when placing an order.

Other heights over 10' are available, consult factory for lead time.

Non-standard center lines or threshold installed - consult customer support.

DEFAULT ATTRIBUTES

Pricing includes default options shown below. Additional options and configurations available.

Cylinders:	Sex bolts	Door thickness	Scalp plate
Not included	Included	1-3/4"	Included

Strike(s):

Exit hardware:

- Includes 150 and 450 strikes

Fire exit hardware:

- Includes 150 and 450 strikes

OPTIONS

605	606	611	612	613	619	622	625	626	626AM	628	629
US3	US4	US9	US10	US10B	US15	US19	US26	US26D	US26DAM	US28	US32
630	630AM	643e	689	691	693	695	706	710	711	721	728
US32D	US32DAM	-	SP28	SP10	SPBLK	SP313	SP4	313	315	US3A	US4A

LESS BOTTOM ROD (LBR/LBL Fire-Rated Devices must be ordered in pairs, and one Auxiliary Fire Pin (AFL) is furnished per pair.)	Specify (Suffix)	Price adjustment
33/3527LBR	LBR	-\$124.00
33/3527-F-LBR (First Leaf)	LBR	\$0.00
33/3527-F-LBR-AFL (Second Leaf)	LBR-ALF	\$0.00
33/3547LBR	LBR	-\$133.00
33/3547-F-LBR (First Leaf)	LBR	\$0.00
33/3547-F-LBR-AFL (Second Leaf)	LBR-ALF	\$0.00

LESS BOTTOM LATCH (LBR/LBL Fire-Rated Devices must be ordered in pairs, and one Auxiliary Fire Pin (AFL) is furnished per pair.)	Specify (Suffix)	Price adjustment
33/3549LBL	LBL	-\$133.00
33/3549-F-LBL (First Leaf)	LBL	-\$133.00
33/3549-F-LBL-AFL (Second Leaf)	LBL-AFL	\$29.00
33/3550WDC-LBL	LBL	-\$133.00
33/3550WDC-F-LBL (First Leaf)	LBL	-\$133.00
33/3550WDC-F-LBL-AFL (Second Leaf)	LBL-AFL	\$29.00

ANTIMICROBIAL COATING - Available in 626 (US26D) and 630 (US32D), use suffix "AM" when ordering. Example: 626AM	Specify (Suffix)	Price adjustment
For device with or without trim	AM	\$73.00
For trim only	AM	\$34.00

CYLINDER DOGGING - Not for use with fire exit hardware	Specify (Prefix)	Price adjustment
Standard baseplate cylinder dogging	CD	\$104.00
Less dogging	LD	\$0.00
Cylinder dogging with indicator	CDSI	\$342.00
Hex dogging with indicator	HDSI	\$246.00

VON DUPRIN REMOTE UNDOGGING AND REMOTE MONITORING KIT	Consult your access control software provider for pricing and specific scope of support.
<ul style="list-style-type: none"> Modular retrofit kit for 98/99 and 33A/35A Series devices Access control managed via an IP or RS1/ RS-485 connection to the gateway through Allegion software alliance members ENGAGE enabled undogging available. See RU/RM data sheet. For details regarding the configurations that are available, please see page 276 of the Schlage Electronics Price Book 	

SWITCHES - Available on all 33A/35A Series devices	Specify (Prefix)	Price adjustment
Request to Exit	RX	\$266.00
Waterproof Request to Exit	WP-RX	\$384.00
Request to Exit Low Current	RX-LC	\$309.00
Request to Exit Double Switch	RX-2	\$331.00
RX to RX-2 Conversion (order part number 050271)	RX-AUX	\$277.00

OPTIONS

605	606	611	612	613	619	622	625	626	626AM	628	629
US3	US4	US9	US10	US10B	US15	US19	US26	US26D	US26DAM	US28	US32
630	630AM	643e	689	691	693	695	706	710	711	721	728
US32D	US32DAM	-	SP28	SP10	SPBLK	SP313	SP4	313	315	US3A	US4A

SWITCHES - Available on all 33A/35A Series devices	Specify (Prefix)	Price adjustment
Latchbolt Monitoring	LX ¹	\$266.00
Latchbolt Monitoring Low Current	LX-LC ¹	\$309.00
Request to Exit / Latchbolt Monitoring combination	LX-RX ¹	\$402.00
Request to Exit / Latchbolt Monitoring combination Low Current	LX-RX-LC ¹	\$483.00
Signal Switch - for Rim and Vertical Rod Devices	SS	\$545.00

¹ For 33/3549A and 33/3550A-WDC, LX switch monitors trim input or electric dogging of EL/QEL devices. LX switch does not monitor latch condition.

See page 175-176 for field-installed switch kit part numbers.

LATCH RETRACTION - See 33A/35A product catalog for required accessory equipment	Specify (Prefix)	Price adjustment
Electric latch retraction	EL	\$1,015.00
Electric latch retraction with hex dogging (panic only)	HD-EL	\$1,015.00
Quiet electric latch retraction	QEL	\$979.00
Quiet electric latch retraction with hex dogging (panic only)	HD-QEL	\$979.00
Quiet electric latch retraction for AX devices	QELX	\$1,041.00
Quiet electric latch retraction with hex dogging (panic only) for AX devices	HD-QELX	\$1,041.00
Pneumatic	PN	\$1,514.00

QUIET MECHANICAL	Specify (Prefix)	Price adjustment
Controls motion to reduce operational noise. The QM device option provides damper-controlled re-latching. Available on 33A/35A rim and 33/3527A devices. Compatible with most of the device options including QEL, EL, AX, RX, and CD. Not available with CX and LX.	QM	\$199.00

CHEXIT - Available on all 33A/35A Series devices	Specify (Prefix)			Price adjustment
	Prefix	Finish	Release delay	
Chexit – Controlled exit device (15 second delay furnished standard) <ul style="list-style-type: none"> Only available with EO, DT, L-DT, L-BE x E360, T-BE x E360T functions DT Function requires an electric strike to access opening Chexit is not available with any electrical options (EL, QEL, PN) Chexit is not available with any switches (RX, RXLC, RX2, WP-RX, LX, LXLC, LXR, LXRXC) For CX33/3527A panic and fire devices, two Rod Guards (RGO) supplied standard. Add \$622.00 list per device. For doors over 7' additional RGO's will be added as needed to protect the rods. For each additional RGO, add \$311.00 List. For latch protection, latch guards (LGO) found on page 162 can be ordered separately 	CXA	-	.[Release delay]	\$1,940.00
Remote Chexit module	RCM	.[Finish]	.[Release delay]	\$277.00
Chexit 10' cable	CXCAB	-	-	\$124.00

OPTIONS

605	606	611	612	613	619	622	625	626	626AM	628	629
US3	US4	US9	US10	US10B	US15	US19	US26	US26D	US26DAM	US28	US32
630	630AM	643e	689	691	693	695	706	710	711	721	728
US32D	US32DAM	-	SP28	SP10	SPBLK	SP313	SP4	313	315	US3A	US4A

RELEASE DELAY	Specify	Price adjustment
0 Second Delay	0 Delay	\$142.00
30 Second Delay ¹	30 Delay ¹	\$142.00
15 second delay with BOCA Modification	BOCA-15 Delay [ⓧ]	\$142.00
30 second delay with BOCA Modification ¹	BOCA-30 Delay ¹ [ⓧ]	\$142.00
2-60 Seconds in 2 Second Intervals or infinite delay ¹	Other Delays ¹ [ⓧ]	\$190.00

15 second Module sold separately, specify part number 040086.

¹ Over 15 second delay requires a letter of approval from the authority having local jurisdiction over the premises prior to the installation of the device. Allegion cannot grant such approval nor does it warrant local jurisdiction compliance.

[ⓧ] Consult factory for lead time.

EXIT ALARM	Specify	Price adjustment
Exit alarm <ul style="list-style-type: none"> Available on 33A, 35A Series panic and fire devices Price includes RX switch; can substitute with LX switch at no additional charge For vertical rod tampering monitoring on Surface Vertical Devices, specify device with LX (Latch Bolt Monitor Switch) To order Less Switch, deduct \$266 list 9 volt battery included 	ALK	\$660.00

PULLMAN LATCHES - Not for use with fire exit hardware	Specify	Price adjustment
33A/3527A device PL top and PL bottom	PL	\$278.00
33A/3547A device PL top and PL bottom	PL	\$386.00
33A/3527A device LBR with PL top latch for electric strike application (a panic LBR device is one-point latching not two point, the security of the opening may be compromised)	ES	\$139.00
33A/3547A device LBR with PL top latch for electric strike application (a panic LBR device is one-point latching not two point, the security of the opening may be compromised)	ES	\$193.00

ELECTRIC UNLOCKING	Specify (Prefix)	Price adjustment
<ul style="list-style-type: none"> Electric unlocking of outside lever or thumbturn controls (-BE trims only) 24VDC furnished standard. 12VDC available, consult factory for lead time. Specify Fail Secure (FSE) or Fail Safe (FS). Prefix lever or thumbturn control with "E" Example: E360L-BE, E360T-BE E374TL-BE and E376TL-BE available, consult factory for lead time. 	E	\$661.00

STORM RATING	Specify (Prefix)	Price adjustment
Hurricane device - 33/3547A-F device with standard strikes	HH	\$0.00

ACCESSIBLE DEVICE	Specify (Prefix)	Price adjustment
<ul style="list-style-type: none"> Accessible device compliant with the California Building Code (Section 11B-309.4) requirement for 5 lb. maximum operational force. Available on AX33/35A, AX33/35A-F Rim, AX33/3549A LBL and LBL-AFL Trim functions available EO, DT, NL, L, LBE, LDT, T, and TBE EL and QELX options available Not available with CX 	AX	\$67.00

OPTIONS

605	606	611	612	613	619	622	625	626	626AM	628	629
US3	US4	US9	US10	US10B	US15	US19	US26	US26D	US26DAM	US28	US32
630	630AM	643e	689	691	693	695	706	710	711	721	728
US32D	US32DAM	-	SP28	SP10	SPBLK	SP313	SP4	313	315	US3A	US4A

PUSHBAR OPTIONS	Specify		Price adjustment
	Suffix	Handing	
Vision impaired touchpad, raised letters and braille, 630 finish. Standard reads "Caution Stairwell." Optional up to 20 alpha / numeric characters on single line, consult factory.	BRAILLE	.[RHR, LHR]	\$134.00
Brass, bronze and stainless touchbar trims embossed "PUSH". No additional charge when specified with device.	EMB	.[RHR, LHR]	\$0.00
Red silk screened touchbar trims (standard on SS devices). "Emergency Exit Only, Push to Open and Sound Alarm" No additional charge when specified with device.	RSS	.[RHR, LHR]	\$0.00
Knurled touchpad. No additional charge when specified with device.	KN	-	\$0.00
Safety glow feature for 3' device	SG	-	\$488.00
Safety glow feature for 4' device	SG	-	\$508.00

WEEP HOLES	Specify	Price adjustment
Drainage (weep) holes in mechanism case. 3' device will have 5 holes - 6" spacing, 4' device will have 7 holes	WH	\$96.00

CONNECTORS	Specify	Price adjustment
Cross-category solution using interconnect components for electrified options. Available with ALK, LX, LXLC, LXR, LXRXL, RX and RXLC switches, CX, EL and QEL	CON	\$0.00

NON-STANDARD DOOR THICKNESS	Specify	Price adjustment
Door thickness > 2-1/4" - <= 4 1/4"		
33A/35A with EO (exit only no trim)	.DT[]	\$96.00
33A/35A with DT (386), NL (386) or NL-OP (388)	.DT[]	\$192.00
33A/35A with L, L-BE (360)	.DT[]	\$235.00
33A/35A with L-DT (360)	.DT[]	\$190.00

INSULCLAD OR APPLIED PANEL - Not available for fire door applications	Specify	Price adjustment
1/2" Panel - for 33/3547A devices	INS-2	\$72.00
1/4" Panel - for 33/3547A devices	INS-4	\$72.00
1/2" Panel - for 33/3549A devices	INS-2	\$72.00
1/4" Panel - for 33/3549A devices	INS-4	\$72.00

KITS

605	606	611	612	613	619	622	625	626	626AM	628	629
US3	US4	US9	US10	US10B	US15	US19	US26	US26D	US26DAM	US28	US32
630	630AM	643e	689	691	693	695	706	710	711	721	728
US32D	US32DAM	-	SP28	SP10	SPBLK	SP313	SP4	313	315	US3A	US4A

QUIET MECHANICAL RETROFIT KITS	Specify	Price each
QM Rim Device Retrofit Kit - 33A/35A Rim	47259560	\$199.00
QM SVR Device Retrofit Kit - 33/3527A	47263418	\$199.00

EL CONVERSION KITS - Field conversion kits for Electric Latch Retraction	Specify				Price each
	Standard		Allegion Connect -CON		
	3' device	4' device	3' device	4' device	
EL baseplate conversion kit	050070	050078	050853	050854	\$1,184.00
HD-EL baseplate conversion kit (hex dogging included, panic only)	050384	050385	050855	050856	\$1,184.00

QEL CONVERSION KITS - Field conversion kits for Quiet Electric Latch Retraction	Specify				Price each
	Standard		Allegion Connect -CON		
	3' device	4' device	3' device	4' device	
Baseplate conversion kits (may be used for ANY conversion application)					
QEL baseplate conversion kit	958003	040065	040063	040066	\$1,029.00
HD-QEL baseplate conversion kit (hex dogging included, panic only)	958004	040067	040064	040068	\$1,029.00
QELX baseplate conversion kit for AX devices	041166	041167	041168	041169	\$1,091.00
HD-QELX Baseplate Conversion Kit for AX devices (hex dogging included, panic only)	041170	041171	041172	041173	\$1,091.00
Modular conversion kits (for non-EL panic devices, for non-EL fire-rated devices sold after October 2014, or for replacing existing motor)					
QEL modular conversion kit	114317	114317	040061	040061	\$979.00
HD-QEL modular conversion kit (hex dogging included, panic only)	958002	958002	040062	040062	\$979.00
QELX modular conversion kit for AX devices	041162	041162	041163	041163	\$1,041.00
HD-QELX modular conversion kit for AX devices (hex dogging Included, panic only)	041164	041164	041165	041165	\$1,041.00

ESL (EMERGENCY SECURE LOCKDOWN) KITS	Specify			Price each
	3' device	4' device	Finish	
33A ESL Kit - Retrofit kit for QEL 33A devices; Panic or Fire (not available in 619 or 630)	967240	967241	.[Finish]	\$425.00
35A ESL Kit - Retrofit kit for QEL 35A, devices; Panic or Fire	967242	967243	.[Finish]	\$425.00

- No WS
- No mechanical dogging of QEL (SD-QEL, HD-QEL)
- Unit requires a standard 1 1/4" (32mm) mortise cylinder with an inverted straight cam and compression ring and spring. Kit does not come with cylinder or thumbturn, must be ordered separately. Examples: Schlage conventional cylinder: 20-001 1 1/4" XQ11-949; Schlage thumbturn cylinder: 09-904 1 1/4" B502-191 XQ11-949; Schlage ADA thumbturn cylinder: 09-904 1 1/4" XB11-720 B502-191 XQ11-949
- Install in alignment with 2018 IBC 1010.2.8 NFPA 101 14.2.2.2.4 or per local AHJ - Only allowed with trim functions: NL, K-NL, L-NL, NL-OP, T-NL

CX OPTIONS	Specify		Price each
	Part number	Finish	
RCM KIT-33A Less Module	040198-00	.[Finish]	\$278.00
RCM KIT-35A Less Module	040199-00	.[Finish]	\$278.00

Z2 SERIES
 33A/35A SERIES
 55 SERIES
 88 SERIES
 98/99 SERIES
 XP98/XP99 SERIES
 94/95 SERIES
 GUARD-X SERIES
 ACCESSORIES / PARTS
 ELECTRICAL / PARTS

KITS

605	606	611	612	613	619	622	625	626	626AM	628	629
US3	US4	US9	US10	US10B	US15	US19	US26	US26D	US26DAM	US28	US32
630	630AM	643e	689	691	693	695	706	710	711	721	728
US32D	US32DAM	-	SP28	SP10	SPBLK	SP313	SP4	313	315	US3A	US4A

LBR/LBL RETROFIT KITS FOR FIRE-RATED DEVICES	Specify	Price each
33/3527-F LBR Kit - Auxiliary fire pin and two required 499F Strikes	050171-32	\$492.00
33/3547-F/47WDC-F/49-F LBR/LBL Kit - Auxiliary fire pin only	051860-32	\$162.00
33/3550WDC-F LBL Kit - Auxiliary fire pin, auxiliary fire latch strike, sleeve, and screws	48968887	\$174.00

49 CABLE SYSTEM Device type and door opening height must be specified when ordering	Specify			Price each
	Device type	Part number	Door height Specify height between 6'0" - 10'0"	
Complete cable system Includes: Top and bottom strikes, latches, centerslides, cables and mounting packs	[]	CS	[]	\$1,036.00
Cable system, less bottom latch Includes: Top strike, top latch, top cable, centerslides and mounting packs	[]	CS-LBL	[]	\$903.00
Cable system, less bottom latch with fire pin kit Includes: Top strike, top latch, top cable, centerslides, mounting packs and fire pin kit	[]	CS-LBL-49AFL	[]	\$1,065.00

For door opening heights less than 6'10" and more than 10', consult factory.
Consult customer support for non-standard center lines or if a threshold is installed.

50 WDC CABLE SYSTEM Device type and door opening height must be specified when ordering	Specify			Price each
	Device type	Part number	Door height Specify height between 6'0" - 10'0"	
Complete cable system Includes: Top and bottom latches, strikes, cables, centerslide and mounting packs	[]	CS	[]	\$1,186.00
Fire-rated complete cable system Includes: Top and bottom latches, strikes, cables, centerslide, mounting packs, fire kit	[]	CS-F	[]	\$1,498.00
Cable system - Less bottom latch Includes: Top latch, strike, cable, centerslide and mounting packs	[]	CS-LBL	[]	\$1,052.00
Fire-rated cable system - Less bottom latch Includes: Top latch, strike, cable, centerslide, mounting packs, fire kit, fire pin kit	[]	CS-LBL-F	[]	\$1,527.00

INSULCLAD OR APPLIED PANEL KITS - Not available for fire door applications	Specify	Price each
1/2" Panel Kit - for 33/3547A devices	050399	\$72.00
1/4" Panel Kit - for 33/3547A devices	050398	\$72.00
1/2" Panel Kit - for 33/3549A devices	24122277	\$72.00
1/4" Panel Kit - for 33/3549A devices	24122293	\$72.00

PARTS AND ACCESSORIES

605	606	611	612	613	619	622	625	626	626AM	628	629
US3	US4	US9	US10	US10B	US15	US19	US26	US26D	US26DAM	US28	US32
630	630AM	643e	689	691	693	695	706	710	711	721	728
US32D	US32DAM	-	SP28	SPIO	SPBLK	SP313	SP4	313	315	US3A	US4A

CENTER CASE										
Description	Specify		Non-Finished	628	626	710	612	606	605	
	Part number	Finish							619 ¹	625
33A/35A Rim Center Case Kit L/Cover	050403	-	\$360.00	-	-	-	-	-	-	-
33/3527A Center Case Kit L/Cover	050404	-	\$360.00	-	-	-	-	-	-	-
33/3547A Center Case Kit L/Cover	050405	-	\$360.00	-	-	-	-	-	-	-
33A/35A-F Rim Center Case Kit L/Cover	117000	-	\$483.00	-	-	-	-	-	-	-
33A/35A Rim Center Case Cover Kit	050483	.[Finish]	-	\$58.00	\$103.00	\$74.00	\$68.00	\$68.00	\$134.00	
33/3527A Center Case Cover Kit	050484	.[Finish]	-	\$58.00	\$103.00	\$74.00	\$68.00	\$68.00	\$134.00	
33/3547A/49A Center Case Cover Kit	050485	.[Finish]	-	\$58.00	\$103.00	\$74.00	\$68.00	\$68.00	\$134.00	
33/35A Center Case Cover Screws	900892	.[Finish]	-	\$14.00	\$14.00	\$14.00	\$14.00	\$14.00	\$14.00	
Control Link Pin Kit	050529	-	\$14.00	-	-	-	-	-	-	
Retaining Ring Pkg/10	090107	-	\$14.00	-	-	-	-	-	-	
Control Link Pin Pkg/10	090031	-	\$17.00	-	-	-	-	-	-	
33A/35A Device Mtg Package - 1 3/4" - 2 1/4" Dr	900619	-	\$14.00	-	-	-	-	-	-	
33/3547A Wood Door Mtg Package	900856	-	\$14.00	-	-	-	-	-	-	

COVER PLATE / CONVERSION KITS										
Description	Specify		Non-Finished	628	626	710	612	606	605	
	Part number	Finish							619 ¹	625
33A Hex Dog Conversion Kit	050114	.[Finish]	-	\$78.00	-	\$78.00	\$78.00	\$78.00	\$78.00	
35A Hex Dog Conversion Kit	050117	.[Finish]	-	\$78.00	-	\$78.00	\$78.00	\$78.00	\$78.00	
33A CD Conversion Kit	050115	.[Finish]	-	\$104.00	-	\$104.00	\$104.00	\$104.00	\$104.00	
35A CD Conversion Kit	050132	.[Finish]	-	\$104.00	-	\$104.00	\$104.00	\$104.00	\$104.00	
33A CDSI Kit 3'4'	040070/040071	.[Finish]	-	\$342.00	\$342.00	\$342.00	\$342.00	\$342.00	\$342.00	
33A HDSI Kit 3'4'	040072/040073	.[Finish]	-	\$246.00	\$246.00	\$246.00	\$246.00	\$246.00	\$246.00	
35A CDSI Kit 3'4'	040074/040075	.[Finish]	-	\$342.00	\$342.00	\$342.00	\$342.00	\$342.00	\$342.00	
35A HDSI Kit 3'4'	040076/040077	.[Finish]	-	\$246.00	\$246.00	\$246.00	\$246.00	\$246.00	\$246.00	
CDSI/HDSI Configuration Pkg	900416-00	-	\$18.00	-	-	-	-	-	-	
33A Fire or Less Dogging Cover Plate Kit	050133	.[Finish]	-	\$48.00	-	\$48.00	\$48.00	\$48.00	\$48.00	
35A Fire or Less Dogging Cover Plate Kit	050109	.[Finish]	-	\$48.00	-	\$48.00	\$48.00	\$48.00	\$48.00	
33A ALK Cover Plate Kit	050406	.[Finish]	-	\$114.00	-	\$114.00	\$114.00	\$114.00	\$114.00	
35A ALK Cover Plate Kit	050407	.[Finish]	-	\$114.00	-	\$114.00	\$114.00	\$114.00	\$114.00	
33A Center Case Cover Plate (1.42")	050474	.[Finish]	-	\$31.00	-	\$31.00	\$31.00	\$31.00	\$31.00	
35A Center Case Cover Plate (1.42")	050475	.[Finish]	-	\$31.00	-	\$31.00	\$31.00	\$31.00	\$31.00	
Cover Plate Anti-Rattle Spring Pkg/10	090036	-	\$14.00	-	-	-	-	-	-	
Dogging Shaft Pkg/2	090040	-	\$14.00	-	-	-	-	-	-	

¹ 619 finish available with Series 35A, only.

Items in **bold print** indicate same part number is used for the old 33/35 Series devices.

PARTS AND ACCESSORIES

605	606	611	612	613	619	622	625	626	626AM	628	629
US3	US4	US9	US10	US10B	US15	US19	US26	US26D	US26DAM	US28	US32
630	630AM	643e	689	691	693	695	706	710	711	721	728
US32D	US32DAM	-	SP28	SP10	SPBLK	SP313	SP4	313	315	US3A	US4A

END CAP										
Description	Specify			Non-Finished	628	626	710	612	606	605 619' 625 711
	Part number	Finish								
33A/35A Impact Resistant End Cap Kit	050014	[Finish]		-	\$86.00	\$96.00	\$86.00	\$107.00	\$97.00	\$97.00
33A/35A Impact Resistant End Cap Scr Pkg	900597	[Finish]		-	-	\$14.00	\$14.00	\$17.00	\$14.00	\$14.00
33A/35A Impact Resistant End Cap Bracket	050524	-		\$12.00	-	-	-	-	-	-
33A/35A-F Impact Resistant End Cap Kit	957901	[Finish]		-	\$82.00	\$92.00	\$82.00	\$103.00	\$94.00	\$94.00

PUSH BAR											
Description	Specify				Non-Finished	628	626	710	612	606	605 619' 625 711
	Part number	Device type	Size	Finish							
33A/35A Push Bar Retrofit Kit - 3' Dr	PBKIT	[]	[]	[Finish]	-	\$223.00	\$263.00	\$242.00	\$360.00	\$348.00	\$412.00
33A/35A Push Bar Retrofit Kit - 4' Dr	PBKIT	[]	[]	[Finish]	-	\$240.00	\$289.00	\$259.00	\$376.00	\$360.00	\$426.00
33A/35A Push Bar Guide Pkg/10	090049			-	\$15.00	-	-	-	-	-	-

MECHANISM CASE										
Description	Specify			Non-Finished	628	626	710	612	606	605 619' 625 711
	Part number	Finish								
33A Mechanism Case - 3' Dr	050486	[Finish]		-	\$155.00	-	\$193.00	\$193.00	\$193.00	\$220.00
33A Mechanism Case - 4' Dr	050487	[Finish]		-	\$220.00	-	\$254.00	\$254.00	\$254.00	\$287.00
35A Mechanism Case - 3' Dr	050488	[Finish]		-	\$155.00	-	\$193.00	\$193.00	\$193.00	\$220.00
35A Mechanism Case - 4' Dr	050489	[Finish]		-	\$220.00	-	\$254.00	\$254.00	\$254.00	\$287.00
CD/SS Cylinder Mtg Kit	107813	[Finish]		-	-	\$64.00	\$68.00	\$68.00	\$68.00	\$74.00
CD/SS Cylinder Locating Washer Pkg	050490			\$17.00	-	-	-	-	-	-
CD/SS Mortise Cylinder Collar Pkg	050525	[Finish]		-	-	\$48.00	\$48.00	\$58.00	\$48.00	\$58.00
CD/SS Cylinder Lock Nut Pkg	050526			\$15.00	-	-	-	-	-	-
CD Actuator Pkg/2	090045	-		\$14.00	-	-	-	-	-	-
CD Dogging Plug Pkg/2 (devices shipped after July 1997)	090046	-		\$13.00	-	-	-	-	-	-
227 Dog Key 5/32" Pkg/2	090005	-		\$22.00	-	-	-	-	-	-
227 Dog Key 5/32" Pkg/10	090085	-		\$76.00	-	-	-	-	-	-
Mechanism Case Brkt Kit	050530	-		\$12.00	-	-	-	-	-	-
Mechanism Case Brkt Screw Pkg/10	090073	-		\$12.00	-	-	-	-	-	-
33A/35A Device Mtg Pkg 1 3/4" - 2 1/4" Door	900619	-		\$14.00	-	-	-	-	-	-
33A/35A Device Mtg Pkg 2 1/4" - 2 3/4"	900380	-		\$33.00	-	-	-	-	-	-
33A/35A Device Mtg Pkg 2 3/4" - 3 1/4"	900429	-		\$95.00	-	-	-	-	-	-
33A/35A Device Mtg Pkg 3 1/4" - 4 1/4"	900430	-		\$95.00	-	-	-	-	-	-
33/3547A Wood Door Mtg Pkg	900856	-		\$14.00	-	-	-	-	-	-

¹ 619 finish available with Series 35A, only.

Items in **bold print** indicate same part number is used for the old 33/35 Series devices.

PARTS AND ACCESSORIES

605	606	611	612	613	619	622	625	626	626AM	628	629
US3	US4	US9	US10	US10B	US15	US19	US26	US26D	US26DAM	US28	US32
630	630AM	643e	689	691	693	695	706	710	711	721	728
US32D	US32DAM	-	SP28	SP10	SPBLK	SP313	SP4	313	315	US3A	US4A

BASEPLATE

Description	Specify		Non-Finished	628	626	710	612	606	605 619 ¹ 625 711
	Part number	Finish							
Shock Absorber Pkg	050491	-	\$33.00	-	-	-	-	-	-
Baseplate Screw Pkg/10	090037	-	\$13.00	-	-	-	-	-	-
Baseplate Bumper Pkg/4	090038	-	\$13.00	-	-	-	-	-	-
Baseplate Return Spring Pkg/10	090039	-	\$14.00	-	-	-	-	-	-
Dogging Shaft Pkg/2	090040	-	\$14.00	-	-	-	-	-	-
Dogging Spring Pkg/2	090041	-	\$13.00	-	-	-	-	-	-
Dogging Adapter Spring Pkg/2	090042	-	\$17.00	-	-	-	-	-	-
Dogging Adapter Pkg/2	090043	-	\$14.00	-	-	-	-	-	-
Dogging Hook Pkg/2	090044	-	\$14.00	-	-	-	-	-	-
227 Dog Key 5/32" Pkg/2	090005	-	\$22.00	-	-	-	-	-	-
227 Dog Key 5/32" Pkg/10	090085	-	\$76.00	-	-	-	-	-	-
EL Dogging Rod Kit - 3'	050531	-	\$67.00	-	-	-	-	-	-
EL Dogging Rod Kit - 4'	050532	-	\$67.00	-	-	-	-	-	-
QEL/MEL Motor Cable with 6' Harness	47269206	-	\$62.00	-	-	-	-	-	-
EL Potted Circuit Breaker	050534	-	\$327.00	-	-	-	-	-	-
EL Solenoid/Plunger	050535	-	\$371.00	-	-	-	-	-	-
HD-EL Solenoid	050536	-	\$371.00	-	-	-	-	-	-
HD-EL Solenoid Plunger	050537	-	\$136.00	-	-	-	-	-	-
EL Dogging Rod Retainer	050538	-	\$15.00	-	-	-	-	-	-
EL Receptacle Connector	050539	-	\$14.00	-	-	-	-	-	-
EL Female Terminal	050540	-	\$14.00	-	-	-	-	-	-
HD-EL Dog Screw	050541	-	\$17.00	-	-	-	-	-	-
HD-EL Solenoid Bracket	050542	-	\$30.00	-	-	-	-	-	-
HD-EL Dogging Spring	050543	-	\$17.00	-	-	-	-	-	-
SS Cable	050544	-	\$146.00	-	-	-	-	-	-
SS Housing	050545	-	\$487.00	-	-	-	-	-	-

VERTICAL LATCHES

Description	Specify		Non-Finished	628	626	710	612	606	605 619 ¹ 625 711
	Part number	Finish							
33/3527A Top Latch Kit Less Cover	050400	-	\$155.00	-	-	-	-	-	-
33/3527A Bottom Latch Kit Less Cover	050401	-	\$155.00	-	-	-	-	-	-
33/3527A Pullman Latch Kit Less Cover	050402	-	\$155.00	-	-	-	-	-	-
33/3547A Top Latch Kit	050492	-	\$302.00	-	-	-	-	-	-
33/3547A Bottom Latch Kit	050493	-	\$245.00	-	-	-	-	-	-
ES33/3547A Top Latch Kit	050128	-	\$220.00	-	-	-	-	-	-
33/3548A Top Latch Kit-(non EL)	050494	-	\$441.00	-	-	-	-	-	-
For service replacement only. Refer to Retrofit Kits 050047, 050048, 050522 and 050523 to convert 33/3547, 33/3547A Device to 33/3548 or 33A/3548A.									

¹ 619 finish available with Series 35A, only.

Items in **bold print** indicate same part number is used for the old 33/35 Series devices.

PARTS AND ACCESSORIES

605	606	611	612	613	619	622	625	626	626AM	628	629
US3	US4	US9	US10	US10B	US15	US19	US26	US26D	US26DAM	US28	US32
630	630AM	643e	689	691	693	695	706	710	711	721	728
US32D	US32DAM	-	SP28	SPIO	SPBLK	SP313	SP4	313	315	US3A	US4A

VERTICAL LATCHES

Description	Specify		Non-Finished	628	626	710	612	606	605 619' 625 711
	Part number	Finish							
EL33/3548A Top Latch Kit For service replacement only. Refer to Retrofit Kits 050047, 050048, 050522 and 050523 to convert 33/3547, 33/3547A Device to 33/3548 or 33A/3548A.	050516	-	\$417.00	-	-	-	-	-	-
33/3548A Bottom Latch Kit For service replacement only. Refer to Retrofit Kits 050047, 050048, 050522 and 050523 to convert 33/3547, 33/3547A Device to 33/3548 or 33A/3548A.	050495	-	\$474.00	-	-	-	-	-	-
33/3548A Latch Retrofit Kit-(non EL)	050047	-	\$739.00	-	-	-	-	-	-
33/3548A-F Latch Retrofit Kit-(non EL)	050048	-	\$739.00	-	-	-	-	-	-
EL33/3548A Latch Retrofit Kit	050522	-	\$739.00	-	-	-	-	-	-
EL33/3548A-F Latch Retrofit Kit	050523	-	\$739.00	-	-	-	-	-	-
33/3527A Latch Cover Kit w/Screws	050496	.[Finish]	-	\$82.00	\$140.00	\$94.00	\$82.00	\$82.00	\$142.00
33/3527A Latch Cover Screw Pkg	900850	.[Finish]	-	\$14.00	\$14.00	\$14.00	\$14.00	\$14.00	\$14.00
33/3527A Top Latch Compression Spring Pkg/10	090056	-	\$14.00	-	-	-	-	-	-
33/3527A PL Top Latch Spring Pkg/10	090057	-	\$14.00	-	-	-	-	-	-
33/3527A Top Latch Aux. Bolt Spring Pkg/10	090076	-	\$14.00	-	-	-	-	-	-
33/3527A-F AFL Strike Hole Plug	050509	-	\$12.00	-	-	-	-	-	-
33/3527A Latch Mtg Bracket Kit	050546	-	\$31.00	-	-	-	-	-	-
33/3527A Latch Screw Pkg	900589	-	\$14.00	-	-	-	-	-	-
33/3527A-F LBR Latch Mounting Package	900980	-	\$13.00	-	-	-	-	-	-
LBR Fire Latch/Strike Kit	050171	-	\$492.00	-	-	-	-	-	-
LBR Strike Plug & Screw Package	900973	-	\$14.00	-	-	-	-	-	-
33/3547A Latch Mounting Bracket Kit	109324	-	\$60.00	-	-	-	-	-	-
33/3548A Latch Mounting Bracket Kit	112868	-	\$68.00	-	-	-	-	-	-
33/3547A Latch Brkt Mtg. Screw (Latch) Pkg/6	090059	-	\$14.00	-	-	-	-	-	-
33/3547A Latch Brkt Mtg. Screw (Door) Pkg/6	090061	-	\$14.00	-	-	-	-	-	-
33/3547A/48A Latch Linkage Pin Retaining Ring Pkg/10	090063	-	\$14.00	-	-	-	-	-	-
33/3547A Latch Link Pin Pkg/10	090064	-	\$14.00	-	-	-	-	-	-
33/3547A Bolt Return Spring Pkg/10	090065	-	\$14.00	-	-	-	-	-	-
33/3547A Top Latch Compression Spring Pkg/10	090066	-	\$13.00	-	-	-	-	-	-
33/3547A Rod Connecting Screw-Latch Pkg/2	090071	-	\$17.00	-	-	-	-	-	-
33/3548A Rod Connecting Screw-Latch Pkg/2	090072	-	\$17.00	-	-	-	-	-	-

VERTICAL RODS

Description	Specify		Non-Finished	628	626	710	612	606	605 619' 625 711
	Part number	Finish							
3327A Top Rod Kit	050512	.[Finish]	-	\$84.00	-	\$99.00	\$115.00	\$115.00	\$115.00
3527A Top Rod Kit	050513	.[Finish]	-	\$84.00	\$99.00	\$99.00	\$115.00	\$115.00	\$115.00

¹ 619 finish available with Series 35A, only.

Items in **bold print** indicate same part number is used for the old 33/35 Series devices.

PARTS AND ACCESSORIES

605	606	611	612	613	619	622	625	626	626AM	628	629
US3	US4	US9	US10	US10B	US15	US19	US26	US26D	US26DAM	US28	US32
630	630AM	643e	689	691	693	695	706	710	711	721	728
US32D	US32DAM	-	SP28	SP10	SPBLK	SP313	SP4	313	315	US3A	US4A

VERTICAL RODS

Description	Specify		Non-Finished	628	626	710	612	606	605 619 ¹ 625 711
	Part number	Finish							
3327A Bottom Rod Kit	050514	.[Finish]	-	\$84.00	-	\$99.00	\$115.00	\$115.00	\$115.00
3527A Bottom Rod Kit	050515	.[Finish]	-	\$84.00	-	\$99.00	\$115.00	\$115.00	\$115.00
33/3547A/48A Adj. Top Rod Kit - 6'8"-8'4" Dr	050519	-	\$99.00	-	-	-	-	-	-
33/3547A/48A Bottom Rod Kit	050520	-	\$99.00	-	-	-	-	-	-
3327A One Piece Top Rod Kit - 8'	050650	.[Finish]	-	\$249.00	\$249.00	\$249.00	\$158.00	\$126.00	\$249.00
3327A One Piece Top Rod Kit - 10'	050651	.[Finish]	-	\$275.00	\$275.00	\$275.00	\$174.00	\$152.00	\$269.00
3327A One Piece Top Rod Kit - 12'	050652	.[Finish]	-	\$291.00	\$291.00	\$291.00	\$192.00	\$179.00	\$302.00
3527A One Piece Top Rod Kit - 8'	050653	.[Finish]	-	\$249.00	\$249.00	\$249.00	\$158.00	\$126.00	\$249.00
3527A One Piece Top Rod Kit - 10'	050654	.[Finish]	-	\$275.00	\$275.00	\$275.00	\$174.00	\$152.00	\$269.00
3527A One Piece Top Rod Kit - 12'	050655	.[Finish]	-	\$291.00	\$291.00	\$291.00	\$192.00	\$179.00	\$302.00
3327A Extension Rod 36" Kit	051807	.[Finish]	-	\$31.00	\$31.00	\$31.00	\$31.00	\$31.00	\$31.00
3527A Extension Rod 36" Kit	051811	.[Finish]	-	\$31.00	\$31.00	\$31.00	\$31.00	\$31.00	\$31.00
3327A Extension Rod 60" Kit	050643	.[Finish]	-	\$277.00	-	\$277.00	\$322.00	\$314.00	\$336.00
3527A Extension Rod 60" Kit	050645	.[Finish]	-	\$277.00	-	\$277.00	\$322.00	\$314.00	\$336.00
33/3547A/48A Extension Rod Kit - Adj 8'4"-10'	051808	-	\$31.00	-	-	-	-	-	-
33/3547A/48A Extension Rod Kit - Adj 10'-11'8"	050622	-	\$103.00	-	-	-	-	-	-
33/3547A/48A Extension Rod Kit - Adj 11'8"-13'4"	050623	-	\$115.00	-	-	-	-	-	-
33/3547A/48A Extension Rod Kit - Adj 13'4"-15'	050624	-	\$115.00	-	-	-	-	-	-
33/3527A Rod Guide Pkg	105952	.[Finish]	-	\$86.00	\$130.00	\$90.00	\$90.00	\$90.00	\$130.00
33/3527A Rod Guide Mtg Pkg	900565	-	\$14.00	-	-	-	-	-	-
33/3527A Rod Roll Pin Pkg/10	090054	-	\$15.00	-	-	-	-	-	-
33/3527A Rod Connector-Latch Pkg/2	090067	-	\$22.00	-	-	-	-	-	-
33/3527A Rod Connector-C/Case Pkg/2	090068	-	\$22.00	-	-	-	-	-	-
33/3547A Ratchet Release Pkg	106222	.[Finish]	-	\$146.00	-	\$146.00	\$146.00	\$146.00	-
33/3547A Ratchet Release Spacer 1/8"	970978	.[Finish]	-	\$23.00	-	\$23.00	\$23.00	\$23.00	-
33/3547A Ratchet Lever Spring Pkg/2	090069	-	\$13.00	-	-	-	-	-	-
33/3547A Ratchet Release Screw Pkg/2	090070	-	\$17.00	-	-	-	-	-	-
33/3547A/-F Rod Connector Extension Bracket	969989	-	\$14.00	-	-	-	-	-	-
33/3547A/-F Rod Connector Screw	972408	-	\$11.00	-	-	-	-	-	-
33/3547A Rod Adjusting Pkg	900620	-	\$23.00	-	-	-	-	-	-
33/3547A 1/4" Insulclad Kit 1 3/4" Dr	050398	-	\$72.00	-	-	-	-	-	-
33/3547A 1/2" Insulclad Kit 1 3/4" Dr	050399	-	\$72.00	-	-	-	-	-	-

PNEUMATIC ACCESSORIES

	Specify	Price each
PNT-1 - Pneumatic power transfer	012014-36	\$664.00
PN connector - PN adapter kit - 5/32" to 1/4" LCN tubing	051827-00	\$41.00
PN 5/32" tubing - 25' length	051828-00	\$27.00
PN 5/32" tubing - 50' length	051823-00	\$35.00

¹ 619 finish available with Series 35A, only.

Items in **bold print** indicate same part number is used for the old 33/35 Series devices.

PARTS AND ACCESSORIES

605	606	611	612	613	619	622	625	626	626AM	628	629
US3	US4	US9	US10	US10B	US15	US19	US26	US26D	US26DAM	US28	US32
630	630AM	643e	689	691	693	695	706	710	711	721	728
US32D	US32DAM	-	SP28	SP10	SPBLK	SP313	SP4	313	315	US3A	US4A

PNEUMATIC ACCESSORIES	Specify	Price each
PN 5/32" tubing - 100' length	051824-00	\$60.00
PN 5/32" tubing - 200' length	051825-00	\$113.00

33A/3549A Series

VERTICAL LATCHES	Specify	Price each
49 Top Latch Assembly	24090110	\$274.00
49 Bottom Latch Assembly	24090128	\$295.00
49 LBL-AFL Fire Pin Kit	051860	\$162.00

CENTERSLIDE KITS	Specify	Price each
33/3549 Centerslide Kit	24090136	\$420.00

49 CABLE	Specify	Price each
For complete 49 Cable System kits, see page 44		
Top Cable Assembly Door Opening Heights 6'0" to 6'10"	47250398	\$238.00
Top Cable Assembly Door Opening Heights 6'10" to 8'0"	47250175	\$238.00
Top Cable Assembly Door Opening Heights >8'0" to 9'2"	47250176	\$238.00
Top Cable Assembly Door Opening Heights >9'2" to 10'4"	47250177	\$238.00
Bottom Cable Assembly Door Opening Heights 6'0" to 6'10"	47250403	\$238.00
Bottom Cable Assembly Door Opening Heights 6'10" to 8'0"	47250178	\$238.00
Bottom Cable Assembly Door Opening Heights >8'0" to 9'2"	47250179	\$238.00
Bottom Cable Assembly Door Opening Heights >9'2" to 10'4"	47250180	\$238.00
Replacement Cable Kit (10' core wire, end fitting, and sizing templates)	47250968	\$99.00

For door opening heights more than 10', consult factory. Consult customer support for non-standard center lines or if a threshold is installed.

MOUNTING PACKAGES	Specify	Price each
49 Bottom Mounting Package	23946437	\$75.00
49 Top Mounting Package	23946429	\$51.00
33/3549A HM/AL Centerside Mounting Package	23946460	\$33.00

MISC.	Specify	Price each
Cable Removal Tool - qty 1	24052979	\$16.00
Cable Removal Tool - Pkg/10	24090706	\$126.00
338 Filler Plate	24230914	\$95.00
Spacer Block Kit 3/4" undercut	24231516	\$32.00
Damper Assembly 996	47259557	\$67.00

33A/3550AWDC Series

VERTICAL LATCHES	Specify	Price each
Top Latch Kit with mounting pack	48968820	\$384.00
Bottom Latch Kit with mounting pack	48968838	\$321.00

PARTS AND ACCESSORIES

605	606	611	612	613	619	622	625	626	626AM	628	629
US3	US4	US9	US10	US10B	US15	US19	US26	US26D	US26DAM	US28	US32
630	630AM	643e	689	691	693	695	706	710	711	721	728
US32D	US32DAM	-	SP28	SP10	SPBLK	SP313	SP4	313	315	US3A	US4A

CENTERSLIDE KITS	Specify	Price each
3350A-WDC Centerslide kit with mounting pack	48973309	\$630.00

FIRE KITS	Specify	Price each
33/3550AWDC-F Fire Kit (fire barrier, intumescent for scalp plate and barrier, mounting packs)	48968879	\$327.00

MOUNTING KIT	Specify	Price each
Top, Bottom, and centerslide Mounting Pkg	24685505	\$33.00
Top Latch Mounting Kit	49000409	\$14.00
Bottom Latch Mounting Kit	49000391	\$14.00

CABLES	Specify	Price each
Top Cable 6'8"-7'0" WDC	24648180	\$58.00
Top Cable 7'1"-8'0" WDC	24647273	\$58.00
Top Cable 8740" WDC	24647281	\$66.00
Top Cable 97-10'0" WDC	24647299	\$66.00
Bottom Cable WDC	24647265	\$58.00

FIRE PIN KIT	Specify	Price each
50WDC Fire pin Kit (current fire pin, fire pin sleeve, fire pin strike)	48968887	\$174.00

LIFT FINGER KIT	Specify	Price each
3350AWDC Lift Finger Kit	24685562	\$97.00

PARTS AND ACCESSORIES

605	606	611	612	613	619	622	625	626	626AM	628	629
US3	US4	US9	US10	US10B	US15	US19	US26	US26D	US26DAM	US28	US32
630	630AM	643e	689	691	693	695	706	710	711	721	728
US32D	US32DAM	-	SP28	SP10	SPBLK	SP313	SP4	313	315	US3A	US4A

PUSH BAR

Push Bar Assemblies are for the SS & RX 330/350 only. Push bars can not be replaced on the standard 330/350 Dummy Push Bar.

Description	Specify				Non-Finished	628	626	710	612	606	605 619' 625 711
	Part number	Device type	Size	Finish							
33A/35A Push Bar Retrofit Kit - 3' Dr	PBKIT	[].	[]	[Finish]	-	\$223.00	\$263.00	\$242.00	\$360.00	\$348.00	\$412.00
33A/35A Push Bar Retrofit Kit - 4' Dr	PBKIT	[].	[]	[Finish]	-	\$240.00	\$289.00	\$259.00	\$376.00	\$360.00	\$426.00
33A/35A Push Bar Guide Pkg/10		090049		-	\$15.00	-	-	-	-	-	-
33A Fire or Less Dogging Cover Plate Kit	050133	[].	[]	[Finish]	-	\$48.00	-	\$48.00	\$48.00	\$48.00	\$48.00
35A Fire or Less Dogging Cover Plate Kit	050109	[].	[]	[Finish]	-	\$48.00	-	\$48.00	\$48.00	\$48.00	\$48.00
RX/SS 330/350 Spacer Pkg/2	090047	[].	[]	-	\$29.00	-	-	-	-	-	-
RX/SS 330/350 Baseplate Bearing Strip Pkg/2	090048	[].	[]	-	\$14.00	-	-	-	-	-	-

SCREW PACKS

Description	Specify		Non-Finished	628	626	710	612	606	605 619' 625 711
	Part number	Finish							
330/350 Push Bar 1 3/4" Door	900835	-	\$14.00	-	-	-	-	-	-
330/350 Push Bar 2 1/4" Door	900836	-	\$14.00	-	-	-	-	-	-
230/990DT x 330/350 1 3/4" Dr	050140	[Finish]	-	-	\$17.00	\$17.00	\$17.00	\$17.00	\$17.00
230/990DT x 330/350 2 1/4" Dr	050141	[Finish]	-	-	\$17.00	\$17.00	\$17.00	\$17.00	\$17.00
696/697DT x 330/350 1 3/4" Dr	050142	[Finish]	-	-	\$17.00	\$17.00	\$17.00	\$17.00	\$17.00
696/697DT x 330/350 2 1/4" Dr	050143	[Finish]	-	-	\$17.00	\$17.00	\$17.00	\$17.00	\$17.00

55 SERIES

605	606	611	612	613	619	622	625	626	626AM	628	629
US3	US4	US9	US10	US10B	US15	US19	US26	US26D	US26DAM	US28	US32
630	630AM	643e	689	691	693	695	706	710	711	721	728
US32D	US32DAM	-	SP28	SP10	SPBLK	SP313	SP4	313	315	US3A	US4A

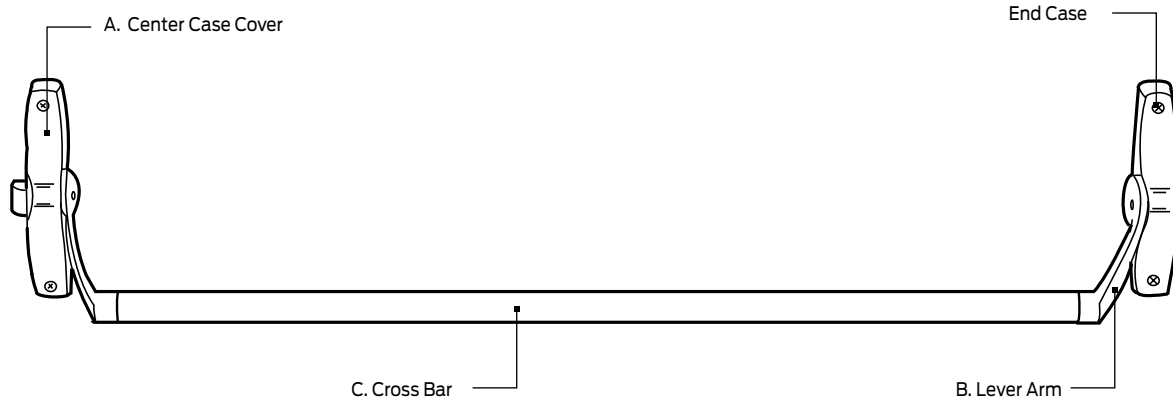

STANDARD FINISHES				
COLOR	US NUMBER	BHMA NUMBER	A, B	C
Bright Brass	US3	605	Buffed Brass, Clear Coat	Buffed Brass, Clear Coat
Satin Brass	US4	606	Satin Brass, Clear Coat	Satin Brass, Clear Coat
Satin Bronze	US10	612	Plated, Clear Coat	Plated, Clear Coat
Satin Bronze, Oil-Rubbed	US10B	613	Oil-Rubbed	Oil-Rubbed
Polished Chrome	US26	625	Plated	Bright Stainless Steel US32, 629
Satin Chrome	US26D	626	Plated	Satin Stainless Steel US32D, 630
Satin Chrome - Antimicrobial	US26D-AM	626-AM	AM Clear over Chrome	AM Clear over Stainless
Aged Bronze	643E	-	Aged Bronze, Relieved	Aged Bronze, no Relief

SPECIAL FINISHES				
COLOR	US NUMBER	BHMA NUMBER	A, B	C
Bright Brass - no Lacquer	US3A	721	Buffed Brass	Bright Brass US3A
Satin Brass - no Lacquer	US4A	728	Satin Brass	Satin Brass US4A
Painted Black	SPBLK	693	Painted	Painted Black, SPBLK

55 SERIES SEX BOLT QUANTITIES	
APPLICATION	625 SEX BOLTS (SUPPLIED)
55 and 5547WDC	4
5547 and 5575	2
5547 EO, DT, NL on Wood Door	4

22 SERIES
 33A/35A SERIES
 55 SERIES
 88 SERIES
 98/99 SERIES
 XP98/XP99 SERIES
 94/95 SERIES
 GUARD-X SERIES
 ACCESSORIES / PARTS
 ELECTRICAL / PARTS

55 SERIES

605	606	611	612	613	619	622	625	626	626AM	628	629
US3	US4	US9	US10	US10B	US15	US19	US26	US26D	US26DAM	US28	US32
630	630AM	643e	689	691	693	695	706	710	711	721	728
US32D	US32DAM	-	SP28	SP10	SPBLK	SP313	SP4	313	315	US3A	US4A

TYPE OF DEVICE			
55 Rim	5547 Concealed Vertical Rod	5547WDC Wood Door Concealed Vertical Rod	5575 Mortise Lock

FUNCTION			
DT: Dummy Trim	EO: Exit Only	L: Lever-06 Standard	LBE: Lever, Blank Escutcheon
LDT: Lever, Dummy Trim	NL: Night Latch, Key Retracts	NLOP: Night Latch, Opt. Pull	TL: Turn Lever
TLBE: Turn Lever, Blank Escutcheon	TLOP: Turn Lever, Opt. Pull		

RATING	
None: Panic Exit Device	- F: Fire Exit Device

DEVICE FINISH			
605: Bright Brass (US3)	606: Satin Brass (US4)	612: Satin Bronze (US10)	613: Satin Bronze-Oil Rubbed (US10B)
625: Bright Chrome (US26)	626: Satin Chrome (US26D)	693: Painted Black (SPBLK)	

DEVICE HANDING	
RHR: Right Hand Reverse	LHR: Left Hand Reverse

TRIM / CONTROL TRIM			
LC: Less Control	LT: Less Trim	110MD-NL: Night Latch with Cyl-HM	110WD-NL: Night Latch with Cyl-WD
371: Lever Control - 5547	375: Lever Control - 5575	376L: Standard 5547 Lever	376L-BE: Lvr-Blank Escutcheon
376T (Thumbturn Control - 5547)	376T WDC: 376T for Wood Door	376WDC-L: 5547 Lever	376WDC-LBE: LBE for Wood Door
379L: Rim - Standard 55 Lever	379L-BE: Lvr-Blank Escutcheon	550DT: Dummy Trim	555NL: Night Latch - HM
555NL-CA: Night Latch with Cyl-HM	556NL: Night Latch - WD	556NL-CA: Night Latch with Cyl-WD	609DT: Dummy Trim
E376L-BE: E-Trim	E376WDC-L-BE: E-Trim	E379L-BE: E-Trim	

CONTROL LEVER STYLES 06 LEVER STANDARD										
Standard levers:	01	02	03	06	07	12	17			
Knurled levers:	03K	06K								

TRIM/CONTROL FINISH			
605: Bright Brass (US3)	606: Satin Brass (US4)	611: Bright Bronze - no Lacquer (US9A)	612: Satin Bronze (US10)
616: Satin Bronze -no Lacquer (US10A)	613: Satin Bronze-Oil Rubbed (US10B)	625: Bright Chrome (US26)	626: Satin Chrome (US26D)

MORTISE LOCK		
LL: Less Lock	7500: Standard Mortise	E7500: Electric Unlocking ¹

¹ For E7500, specify FS (Fail Safe) or FSE (Fail Secure). DC standard, specify AC if required. 24VDC standard, specify 12VDC if required.

MORTISE LOCK FINISH			
605: Bright Brass (US3)	606: Satin Brass (US4)	612: Satin Bronze (US10)	613: Satin Bronze-Oil Rubbed (US10B)
630: Satin Stainless (US32D)	693: Painted Black (SPBLK)	622: Matte Black (US19)	629: Bright Stainless Steel (US32)

55 SERIES

605	606	611	612	613	619	622	625	626	626AM	628	629
US3	US4	US9	US10	US10B	US15	US19	US26	US26D	US26DAM	US28	US32
630	630AM	643e	689	691	693	695	706	710	711	721	728
US32D	US32DAM	-	SP28	SP10	SPBLK	SP313	SP4	313	315	US3A	US4A

RODS FOR CONCEALED VERTICAL DEVICES ONLY

LBR: Less Bottom Rod

SWITCH OPTIONS

RX : Request to Exit

ELECTRICAL LOCKING

E: Electric Locking - Mortise, FS or FSE ES: Pullman Latch for Electric Strike

STRIKE SERIES

LS: Less Strike	LTS: Less Top Strike	1409: Standard 55 Rim	1410: Optional Rim
1609: Optional Rim	1606: Optional Rim	264: Optional Rim or SV	299: Optional Rim
338: Standard CV 5547	471U: Standard CV 5547	472U: Optional 5547WDC 1-3/4	473U: Optional 5547WDC 2-1/4
575: Standard 5575 Mortise	575-2: Optional 5575 Mortise	576A: Optional 5575 1-3/4	576B: Optional 5575 2-1/4

BOTTOM STRIKE SERIES

LBS: Less Bottom Strike	301L: Standard 5547-F	304L: Standard 5547	385A: Optional
-------------------------	-----------------------	---------------------	----------------

STRIKE FINISH

605: Bright Brass (US3)	606: Satin Brass (US4)	612: Satin Bronze (US10)	613: Satin Bronze-Oil Rubbed (US10B)
622: Matte Black (US19)	625: Bright Chrome (US26)	626: Satin Chrome (US26D)	629: Bright Stainless (US32)
630: Satin Stainless (US32D)	691: Satin Bronze (SP10)	695: Duranodic Dark Bronze (313)	MD: e-Moly
611: Bright Bronze - no Lacquer (US9A)	616: Satin Bronze -no Lacquer (US10A)		

CROSS BAR OPTIONS

RCB: Reinforced Crossbar KN: Knurled

CENTERLINE OPTIONS

NY5547: Lever at 45 13/16" NYCA5547: Lever at 44"

MISC DEVICE OPTIONS

10WDA: #10WDA Cover Plate 589: WD Cover Plate CYL: Include Cylinder

SLM BLOCKING

SLM: Include SLM Blocking

DOOR MATERIAL

ALD: Aluminum door CP: Composite door HMD: Hollow metal WD: Wood door

DOOR THICKNESS

DT1-3/4: 1-3/4" Standard DT2: 2" thickness DT2-1/4: 2-1/4" thickness

DOOR/MODE APPLICATION

DE: Pair Double egress doors PR: Pair of doors SGL: Single door

55 SERIES

605	606	611	612	613	619	622	625	626	626AM	628	629
US3	US4	US9	US10	US10B	US15	US19	US26	US26D	US26DAM	US28	US32
630	630AM	643e	689	691	693	695	706	710	711	721	728
US32D	US32DAM	-	SP28	SP10	SPBLK	SP313	SP4	313	315	US3A	US4A

Rim devices

ACN						PRICE BASED ON FINISH						Default trim, included
Device type	Function	Finish	Device size	Handing	Lever design	626	613	612	606	605	625	
						643E	693					
EXIT HARDWARE						3' DEVICE PRICING SHOWN. 4' ADD \$19.00 LIST						
55	. EO	. []	. []			\$2,940	\$2,920	\$2,755	\$2,637	\$3,181	\$3,181	N/A
55	. DT	. []	. []			\$3,532	\$3,512	\$3,354	\$3,105	\$3,791	\$3,791	550DT
55	. NL	. []	. []	. []		\$3,672	\$3,652	\$3,494	\$3,235	\$3,931	\$3,931	550DT/110MD/WD
55	. NL-OP	. []	. []			\$3,080	\$3,060	\$2,895	\$2,767	\$3,321	\$3,321	110MD/WD
55	. L	. []	. []	. []	. []	\$3,885	\$3,855	\$3,700	\$3,469	\$4,205	\$4,116	379L ¹
55	. L-BE	. []	. []	. []	. []	\$3,846	\$3,816	\$3,661	\$3,430	\$4,166	\$4,077	379L-BE ¹

☞ Consult factory for lead time.

¹ Wood Doors - #10 WDA cover plate is supplied at an additional, \$56 list add.

☞ 55 Series devices are handed and field reversible. RHR handing is furnished standard when handing is not specified.

Lever trim is handed and not field reversible, specify handing RHR or LHR.

DEFAULT ATTRIBUTES

Pricing includes default options shown below. Additional options and configurations available.

Cylinders:	Sex bolts	Door thickness	Center line
Not included	Included	1-3/4"	39-13/16"

Strike(s):

Exit hardware:
 ■ Includes 1409 strike

55 SERIES

Concealed vertical rod devices (47)

605	606	611	612	613	619	622	625	626	626AM	628	629
US3	US4	US9	US10	US10B	US15	US19	US26	US26D	US26DAM	US28	US32
630	630AM	643e	689	691	693	695	706	710	711	721	728
US32D	US32DAM	-	SP28	SP10	SPBLK	SP313	SP4	313	315	US3A	US4A

ACN							PRICE BASED ON FINISH						Default trim, included
Device type	Function	Fire	Finish	Device size	Handing	Lever design	626	613	612	606 [Ⓢ]	605 [Ⓢ] 625 643E	693 [Ⓢ]	
							3' DEVICE PRICING SHOWN. 4' ADD \$19.00 LIST						
EXIT HARDWARE							3' DEVICE PRICING SHOWN. 4' ADD \$19.00 LIST						
5547	. EO	. []	. []				\$3,618	\$3,836	\$3,544	\$3,441	\$4,019	\$4,019	N/A
5547	. DT	. []	. []				\$4,210	\$4,428	\$4,143	\$3,909	\$4,629	\$4,629	550DT
5547	. NL	. []	. []	. []	. []		\$4,397	\$4,615	\$4,330	\$4,096	\$4,816	\$4,816	555NL [Ⓢ]
5547	. NL-OP	. []	. []				\$4,003	\$4,221	\$3,929	\$3,765	\$4,404	\$4,404	555CA
5547	. L	. []	. []	. []	. []		\$4,541	\$4,749	\$4,467	\$4,251	\$5,021	\$4,932	376L
5547	. L-BE	. []	. []	. []	. []		\$4,504	\$4,712	\$4,430	\$4,214	\$4,984	\$4,895	376L-BE
5547	. TL	. []	. []				\$4,992	\$5,210	\$4,985	\$4,583	\$5,471	\$5,411	550DT/376T
5547	. TL-BE	. []	. []				\$4,949	\$5,167	\$4,942	\$4,540	\$5,428	\$5,368	550DT/376T-BE
FIRE EXIT HARDWARE²							3' DEVICE PRICING SHOWN. 4' ADD \$19.00 LIST						
5547	. EO	. F	. []	. []			\$3,965	\$4,183	\$3,891	\$3,788	\$4,366	\$4,366	N/A
5547	. DT	. F	. []	. []			\$4,557	\$4,775	\$4,490	\$4,256	\$4,976	\$4,976	550DT
5547	. L	. F	. []	. []	. []		\$4,747	\$4,955	\$4,673	\$4,457	\$5,227	\$5,138	371L
5547	. L-BE	. F	. []	. []	. []		\$4,711	\$4,919	\$4,637	\$4,421	\$5,191	\$5,102	371L-BE
5547	. TL	. F	. []	. []			\$5,150	\$5,368	\$5,136	\$4,773	\$5,654	\$5,551	609DT/376T
5547	. TL-BE	. F	. []	. []			\$5,107	\$5,325	\$5,093	\$4,730	\$5,611	\$5,508	609DT/376-BE

[Ⓢ] Consult factory for lead time.

¹ 5547L - Minimum control centerline of lever or thumbturn is 49-7/8" and the minimum stile width is 1-3/4". If lower lever mounting height is required, consider NY5547L for 45-13/16" or NYCA5547L for 44" lever mounting height.

² 5547-F - Flush transom installation, specify #900614 Release Bracket, \$130 list add per device.

[Ⓢ] 55 Series devices are handed and field reversible. RHR handing is furnished standard when handing is not specified.

Lever trim is handed and not field reversible, specify handing RHR or LHR.

DEFAULT ATTRIBUTES

Pricing includes default options shown below. Additional options and configurations available.

Cylinders:	Sex bolts	Door thickness	Center line
Not included	Included	1-3/4"	39-13/16"

Strike(s):

Exit hardware:

- Includes 471U and 304L strikes

Fire exit hardware:

- Hollow metal doors only
- Includes 301L strike

55 SERIES

605	606	611	612	613	619	622	625	626	626AM	628	629
US3	US4	US9	US10	US10B	US15	US19	US26	US26D	US26DAM	US28	US32
630	630AM	643e	689	691	693	695	706	710	711	721	728
US32D	US32DAM	-	SP28	SP10	SPBLK	SP313	SP4	313	315	US3A	US4A

Wood Door Concealed vertical rod devices (47-WDC)

ACN							PRICE BASED ON FINISH						Default trim, included
Device type	Function	Fire	Finish	Device size	Handing	Lever design	626	613	612	606 [Ⓜ]	605 [Ⓜ] 625 643E	693 [Ⓜ]	
							3' DEVICE PRICING SHOWN. 4' ADD \$19.00 LIST						
EXIT HARDWARE							3' DEVICE PRICING SHOWN. 4' ADD \$19.00 LIST						
5547-WDC	. EO	. []	. []				\$4,082	\$4,257	\$3,695	\$3,584	\$4,322	\$4,322	N/A
5547-WDC	. DT	. []	. []				\$4,674	\$4,849	\$4,294	\$4,052	\$4,932	\$4,932	550DT
5547-WDC	. NL	. []	. []	. []	. []		\$4,861	\$5,036	\$4,481	\$4,239	\$5,119	\$5,119	556NL [Ⓜ]
5547-WDC	. NL-OP	. []	. []				\$4,467	\$4,642	\$4,080	\$3,908	\$4,707	\$4,707	556CA
5547-WDC	. L ¹	. []	. []	. []	. []	. []	\$5,061	\$5,226	\$4,674	\$4,450	\$5,380	\$5,291	376WDC-L/10WDA
5547-WDC	. L-BE ¹	. []	. []	. []	. []	. []	\$5,024	\$5,189	\$4,637	\$4,413	\$5,343	\$5,254	376WDC-L-BE/10WDA
5547-WDC	. TL	. []	. []				\$5,512	\$5,687	\$5,192	\$4,782	\$5,830	\$5,770	550DT/376WDC-T/10WDA
5547-WDC	. TL-BE	. []	. []				\$5,469	\$5,644	\$5,149	\$4,739	\$5,787	\$5,727	550DT/376WDC-T-BE/10WDA
FIRE EXIT HARDWARE							3' DEVICE PRICING SHOWN. 4' ADD \$19.00 LIST						
5547-WDC	. EO	. F	. []	. []			\$4,262	\$4,437	\$3,875	\$3,764	\$4,502	\$4,502	N/A
5547-WDC	. DT	. F	. []	. []			\$4,854	\$5,029	\$4,474	\$4,232	\$5,112	\$5,112	550DT
5547-WDC	. NL	. F	. []	. []	. []		\$5,041	\$5,216	\$4,661	\$4,419	\$5,299	\$5,299	556NL [Ⓜ]
5547-WDC	. NL-OP	. F	. []	. []			\$4,647	\$4,822	\$4,260	\$4,088	\$4,887	\$4,887	556CA
5547-WDC	. L ¹	. F	. []	. []	. []	. []	\$5,241	\$5,406	\$4,854	\$4,630	\$5,560	\$5,471	376WDC-L/10WDA
5547-WDC	. L-BE ¹	. F	. []	. []	. []	. []	\$5,204	\$5,369	\$4,817	\$4,593	\$5,523	\$5,434	376WDC-L-BE/10WDA
5547-WDC	. TL	. F	. []	. []			\$5,692	\$5,867	\$5,372	\$4,962	\$6,010	\$5,950	550DT/376WDC-T/10WDA
5547-WDC	. TL-BE	. F	. []	. []			\$5,649	\$5,824	\$5,329	\$4,919	\$5,967	\$5,907	550DT/376WDC-T-BE/10WDA

[Ⓜ] Consult factory for lead time.

¹ 5547-WDC-L - Minimum centerline 45-13/16".

[Ⓜ] 55 Series devices are handed and field reversible. RHR handing is furnished standard when handing is not specified. Lever trim is handed and not field reversible, specify handing RHR or LHR.

Wood frame applications - specify 472U (1 3/4" Dr.) or 473U (2 1/4" Dr.) top strike.

DEFAULT ATTRIBUTES

Pricing includes default options shown below. Additional options and configurations available.

Cylinders:	Sex bolts	Door thickness	Scalp plate
Not included	Included	1-3/4"	Included

Strike(s):

Exit hardware:

- Includes 338 and 304L strikes

Fire exit hardware:

- Includes 338 and 304L strikes

55 SERIES

605	606	611	612	613	619	622	625	626	626AM	628	629
US3	US4	US9	US10	US10B	US15	US19	US26	US26D	US26DAM	US28	US32
630	630AM	643e	689	691	693	695	706	710	711	721	728
US32D	US32DAM	-	SP28	SP10	SPBLK	SP313	SP4	313	315	US3A	US4A

Mortise lock devices (75)

ACN							PRICE BASED ON FINISH					Default trim, included	
Device type	Function	Fire	Finish	Device size	Handing	Lever design	626	613	612	606 [Ⓢ]	605 [Ⓢ] 625 643E		693 [Ⓢ]
EXIT HARDWARE							3' DEVICE PRICING SHOWN. 4' ADD \$19.00 LIST						
5575	. EO	. []	. []				\$2,791	\$3,254	\$2,637	\$2,549	\$3,231	\$3,231	N/A
5575	. DT	. []	. []				\$3,383	\$3,846	\$3,236	\$3,017	\$3,841	\$3,841	550DT
5575	. NL	. []	. []	. []	. []		\$3,383	\$3,846	\$3,236	\$3,017	\$3,841	\$3,841	550DT
5575	. L	. []	. []	. []	. []		\$3,720	\$4,173	\$3,566	\$3,365	\$4,239	\$4,150	375L ¹
5575	. L-BE	. []	. []	. []	. []		\$3,677	\$4,130	\$3,523	\$3,322	\$4,196	\$4,107	375L-BE ¹
5575	. L-DT	. []	. []	. []	. []		\$3,664	\$4,117	\$3,510	\$3,309	\$4,183	\$4,094	375L-DT ¹
FIRE EXIT HARDWARE²							3' DEVICE PRICING SHOWN. 4' ADD \$19.00 LIST						
5575	. EO	. F	. []	. []			\$3,022	\$3,485	\$2,868	\$2,780	\$3,462	\$3,462	N/A
5575	. DT	. F	. []	. []			\$3,614	\$4,077	\$3,467	\$3,248	\$4,072	\$4,072	550DT
5575	. NL	. F	. []	. []	. []		\$3,614	\$4,077	\$3,467	\$3,248	\$4,072	\$4,072	550DT
5575	. L	. F	. []	. []	. []		\$3,951	\$4,404	\$3,797	\$3,596	\$4,470	\$4,381	375L ¹
5575	. L-BE	. []	. []	. []	. []		\$3,908	\$4,361	\$3,754	\$3,553	\$4,427	\$4,338	375L-BE ¹

[Ⓢ] Consult factory for lead time.

¹ Wood Doors - 589 cover plate is required for 5575 devices on wood doors and will be supplied at an additional price. Refer to page 159 for price by finish.

[Ⓢ] 55 Series devices are handed and field reversible. RHR handing is furnished standard when handing is not specified.

Lever trim is handed and not field reversible, specify handing RHR or LHR.

Door Thickness 2 1/4" - for wood door is a Special Order Product. Consult factory for lead time.

DEFAULT ATTRIBUTES

Pricing includes default options shown below. Additional options and configurations available.

Cylinders:	Sex bolts	Door thickness	Center line
Not included	Included	1-3/4"	39-13/16"

Strike(s):

Exit hardware:

- Includes 575 strike

Fire exit hardware:

- Includes 575 strike

OPTIONS

605	606	611	612	613	619	622	625	626	626AM	628	629
US3	US4	US9	US10	US10B	US15	US19	US26	US26D	US26DAM	US28	US32
630	630AM	643e	689	691	693	695	706	710	711	721	728
US32D	US32DAM	-	SP28	SP10	SPBLK	SP313	SP4	313	315	US3A	US4A

SWITCHES	Specify (Prefix)	Price adjustment
Request to Exit - Crossbar monitor switch in end case <ul style="list-style-type: none"> Factory install only 	RX	\$266.00
PULLMAN LATCHES - Not for use with fire exit hardware	Specify	Price adjustment
ES Pullman Top Latch for 5547 Device (Metal doors, LBR only)	ES	\$290.00
ELECTRIC UNLOCKING	Specify (Prefix)	Price adjustment
<ul style="list-style-type: none"> Electric unlocking of outside lever for all 5575 mortise devices Available with 5575 mortise L-BE and L-BE-F lever trim only For 24VAC installation a SO24 Rectifier Kit will be supplied at an additional \$45 list add. Specify FAIL SECURE (FSE) or FAIL SAFE (FS). SO rectifier kit intended for fail secure / momentary use only. Contact product support for assistance. 	E	\$661.00
<ul style="list-style-type: none"> Electric unlocking of outside 55 Series lever or thumbturn controls Available with 371L-BE, 376L-BE, 376WDC-L-BE, 379L-BE, 376T-BE, 376WDC-T-BE functions only 24VDC furnished standard Prefix Lever or Thumbturn Control with "E" Example: E371L-BE 		\$661.00
CROSSBAR OPTIONS	Specify (Prefix)	Price adjustment
Reinforced Crossbar	RCB	\$112.00
Knurled Crossbar (KN must be ordered as 4' device; cut bar as needed)	KN	\$130.00
CENTERLINE OPTIONS	Specify (Prefix)	Price adjustment
Lever at 45-13/16", device at standard centerline 39-13/16" from finished floor, Up to 10" opening (metal doors)	NY5547 (L, LBE, LDT)	\$0.00
Lever at 44", device at centerline 38" from finished floor, Up to 8' opening (metal doors)	NYCA5547 (L, LBE, LDT)	\$80.00

PARTS AND ACCESSORIES

605	606	611	612	613	619	622	625	626	626AM	628	629
US3	US4	US9	US10	US10B	US15	US19	US26	US26D	US26DAM	US28	US32
630	630AM	643e	689	691	693	695	706	710	711	721	728
US32D	US32DAM	-	SP28	SP10	SPBLK	SP313	SP4	313	315	US3A	US4A

CENTER CASE KITS (INCLUDES MOUNTING SCREWS)

Description	Specify		Non-Finished	613, 626	612	606	605, 625, 693
	Part number	Finish					
55EO Center Case Kit	050183	.[Finish]	-	\$899.00	\$970.00	\$899.00	\$1,142.00
55NL Center Case Kit	050184	.[Finish]	-	\$963.00	\$1,088.00	\$963.00	\$1,206.00
5575 Center Case RHR Kit	050185	.[Finish]	-	\$573.00	\$639.00	\$573.00	\$730.00
5575 Center Case LHR Kit	050186	.[Finish]	-	\$573.00	\$639.00	\$573.00	\$730.00
5575-F Center Case RHR Kit	050187	.[Finish]	-	\$636.00	\$706.00	\$636.00	\$797.00
5575-F Center Case LHR Kit	050188	.[Finish]	-	\$636.00	\$706.00	\$636.00	\$797.00
5547 RHR Center Case Kit	050189	.[Finish]	-	\$573.00	\$639.00	\$573.00	\$730.00
5547 LHR Center Case Kit	050191	.[Finish]	-	\$573.00	\$639.00	\$573.00	\$730.00
5547-F RHR Center Case Kit	050192	.[Finish]	-	\$636.00	\$706.00	\$636.00	\$797.00
5547-F LHR Center Case Kit	050193	.[Finish]	-	\$636.00	\$706.00	\$636.00	\$797.00
5547WDC RHR Center Case Kit	050194	.[Finish]	-	\$636.00	\$706.00	\$636.00	\$797.00
5547WDC LHR Center Case Kit	050195	.[Finish]	-	\$636.00	\$706.00	\$636.00	\$797.00

CENTER CASE PARTS - RIM

Description	Specify		Non-Finished	613, 626	612	606	605, 625, 693
	Part number	Finish					
55CK-NL Conversion Kit (Order Trim Separate)	050105	-	\$59.00	-	-	-	-
55 Rim Backplate w/Screws	050332	.[Finish]	-	\$77.00	\$82.00	\$77.00	\$82.00
55 Case Bushing	050333	-	\$17.00	-	-	-	-
55 Rim Spring Clip w/Screws	050334	-	\$25.00	-	-	-	-
55 Rim Latch Bolt w/Axle and Spring	050352	-	\$170.00	-	-	-	-
55 Rim Latch Bolt Axle	050353	-	\$14.00	-	-	-	-
55 Rim Latch Bolt Spring	050354	-	\$14.00	-	-	-	-
55NL CAM RH	050355	-	\$38.00	-	-	-	-
55NL CAM LH	050356	-	\$38.00	-	-	-	-
55 Axle Retainer Pkg/2	090023	-	\$30.00	-	-	-	-
55 Spring Anchor Screw Pkg/10	090024	-	\$12.00	-	-	-	-
55 Backplate Screw Pkg/10	090025	-	\$12.00	-	-	-	-
55 Rim Center Case Retaining Screw Pkg/2	090022	-	\$48.00	-	-	-	-
55 Rim Center Case Retaining Screw Pkg/10	090050	-	\$216.00	-	-	-	-
55 Rim Center Case Mounting Pkg	900507	.[Finish]	-	\$14.00	\$14.00	\$14.00	\$14.00
55 Rim 2" Dr SNB Mounting Pkg	900512	.[Finish]	-	\$14.00	\$14.00	\$14.00	\$14.00

PARTS AND ACCESSORIES

605	606	611	612	613	619	622	625	626	626AM	628	629
US3	US4	US9	US10	US10B	US15	US19	US26	US26D	US26DAM	US28	US32
630	630AM	643e	689	691	693	695	706	710	711	721	728
US32D	US32DAM	-	SP28	SP10	SPBLK	SP313	SP4	313	315	US3A	US4A

CENTER CASE PARTS - 5547

Description	Specify		Non-Finished	613, 626	612	606	605, 625, 693
	Part number	Finish					
5547 Control Lever	050357	-	\$54.00	-	-	-	-
55 Retaining Screw Pkg/10	090051	-	\$216.00	-	-	-	-
55 Retaining Screw Pkg/2	090026	-	\$48.00	-	-	-	-
55 Case Bushing	050333	-	\$17.00	-	-	-	-
5547 Center Case Mounting Pkg	900508	[Finish]	-	\$14.00	\$14.00	\$14.00	\$14.00
5547 2" Dr SNB Mounting Pkg	900514	[Finish]	-	\$14.00	\$14.00	\$14.00	\$14.00
5547 Blind Fastener Package	900539	-	\$49.00	-	-	-	-

CENTER CASE KITS – 5547–F/5547WDC/5575/5575–F

Description	Specify		Non-Finished	613, 626	612	606	605, 625, 693
	Part number	Finish					
5547-F/47WDC/75/75F Lift Member	050360	-	\$115.00	-	-	-	-
5547-F/47WDC Lift Member Channel	050359	-	\$43.00	-	-	-	-
5547/47–F Latch Release Spring	050362	-	\$14.00	-	-	-	-
5547-F/47WDC Spring Anchor	050363	-	\$17.00	-	-	-	-
5547-F/47WDC Lift Member Lever	050358	-	\$57.00	-	-	-	-
55 Case Bushing	050333	-	\$17.00	-	-	-	-
55 Retaining Screw Pkg/10	090051	-	\$216.00	-	-	-	-
55 Retaining Screw Pkg/2	090026	-	\$48.00	-	-	-	-
55 Spring Anchor Screw Pkg/10	090024	-	\$12.00	-	-	-	-
Lift Member Guide Screw Pkg/10	090027	-	\$12.00	-	-	-	-
5547-F/5575/75-F Center Case Mounting Pkg	900509	[Finish]	-	\$14.00	\$14.00	\$14.00	\$14.00
5547WDC Center Case Mounting Pkg	900507	[Finish]	-	\$14.00	\$14.00	\$14.00	\$14.00
5547WDC 2" Dr SNB Mounting Pkg	900512	[Finish]	-	\$14.00	\$14.00	\$14.00	\$14.00
5547/75 2" Dr SNB Mounting Pkg	900514	[Finish]	-	\$14.00	\$14.00	\$14.00	\$14.00

CROSSBARS

Description	Specify		Non-Finished	613, 626	612	606	605, 625, 693
	Part number	Finish					
42" Standard Crossbar Kit	050004	[Finish]	-	\$242.00	\$248.00	\$242.00	\$255.00
42" Knurled Crossbar Kit	050005	[Finish]	-	\$390.00	\$396.00	\$390.00	\$420.00
37" Crossbar Reinforcement Kit	050459	-	\$131.00	-	-	-	-

PARTS AND ACCESSORIES

605	606	611	612	613	619	622	625	626	626AM	628	629
US3	US4	US9	US10	US10B	US15	US19	US26	US26D	US26DAM	US28	US32
630	630AM	643e	689	691	693	695	706	710	711	721	728
US32D	US32DAM	-	SP28	SPIO	SPBLK	SP313	SP4	313	315	US3A	US4A

END CASE

Description	Specify		Non-Finished	613, 626	612	606	605, 625, 693
	Part number	Finish					
55R/5575/5547 RHR End Case Kit	050196	.[Finish]	-	\$387.00	\$420.00	\$387.00	\$547.00
55R/5575/5547 LHR End Case Kit	050197	.[Finish]	-	\$387.00	\$420.00	\$387.00	\$547.00
5547/75-F RHR End Case Kit	050198	.[Finish]	-	\$387.00	\$420.00	\$387.00	\$547.00
5547/75-F LHR End Case Kit	050199	.[Finish]	-	\$387.00	\$420.00	\$387.00	\$547.00
RX5547/75/-F LHR End Case Kit	040000	.[Finish]	-	\$728.00	\$763.00	\$728.00	\$893.00
RX5547/75/-F RHR End Case Kit	040001	.[Finish]	-	\$728.00	\$763.00	\$728.00	\$893.00
55 Series End Case Backplate	050364	-	\$17.00	-	-	-	-
55 Retaining Screw Pkg/10	090051	-	\$216.00	-	-	-	-
55 Retaining Screw Pkg/2	090026	-	\$48.00	-	-	-	-
55 End Case Spring Pkg/20	090052	-	\$84.00	-	-	-	-
55 End Case Spring Pkg/4	090028	-	\$41.00	-	-	-	-
55 End Case Spring Lever	050366	-	\$48.00	-	-	-	-
55 Series End Case Mounting Pkg	900507	.[Finish]	-	\$14.00	\$14.00	\$14.00	\$14.00

LEVER ARMS

Description	Specify		Non-Finished	613, 626	612	606	605, 625, 693
	Part number	Finish					
55 R/M/CV LH Lever Arm Kit	050112	.[Finish]	-	\$414.00	\$441.00	\$360.00	\$473.00
55 R/M/CV RH Lever Arm Kit	050136	.[Finish]	-	\$414.00	\$441.00	\$360.00	\$473.00
5547-F/75-F LH Lever Arm Kit	050137	.[Finish]	-	\$414.00	\$441.00	\$360.00	\$473.00
5547-F/75-F RH Lever Arm Kit	050139	.[Finish]	-	\$414.00	\$441.00	\$360.00	\$473.00

55 CROSSBAR MISC.

Description	Specify		Non-Finished	613, 626	612	606	605, 625, 693
	Part number	Finish					
55 Wedgetite Screw Pkg/2	090008	-	\$11.00	-	-	-	-
55 Wedgetite Screw Pkg/30	090081	-	\$57.00	-	-	-	-
Crossbar Tube Attaching Wedge Pkg/2	090020	-	\$14.00	-	-	-	-
Crossbar Tube Attaching Ring Pkg/2	090021	-	\$17.00	-	-	-	-
55 Dog Screw Pkg/2	090029	-	\$25.00	-	-	-	-
55 Dog Screw Pkg/10	090053	-	\$77.00	-	-	-	-
227 Dog Key 5/32" Pkg/2	090005	-	\$22.00	-	-	-	-
227 Dog Key 5/32" Hex Pkg/10	090085	-	\$76.00	-	-	-	-
55 Series Special Hex Key (Reversing Pkg)	103866	-	\$14.00	-	-	-	-

PARTS AND ACCESSORIES

605	606	611	612	613	619	622	625	626	626AM	628	629
US3	US4	US9	US10	US10B	US15	US19	US26	US26D	US26DAM	US28	US32
630	630AM	643e	689	691	693	695	706	710	711	721	728
US32D	US32DAM	-	SP28	SP10	SPBLK	SP313	SP4	313	315	US3A	US4A

VERTICAL LATCHES

Description	Specify		Non-Finished	613, 626	612	606	605, 625, 693
	Part number	Finish					
5547-F Soffit Latch Kit	114141	-	\$218.00	-	-	-	-
5547-F Release Guide Cover w/Screws	050278	.[Finish]	-	\$216.00	\$216.00	\$216.00	\$293.00
5547/47WDC Bottom Bracket Guide	050370	-	\$90.00	-	-	-	-
5547 Rod Connector Rivet Pkg/10	090011	-	\$12.00	-	-	-	-
5547WDC Top Plate Screw Pkg Pkg/10	090033	-	\$15.00	-	-	-	-
5547-F Plunger Release Brkt Screws Pkg/10	090034	.[Finish]	-	\$23.00	\$23.00	\$23.00	\$23.00
5547-F Flush Tran. Release Screws Pkg/10	090035	.[Finish]	-	\$17.00	\$17.00	\$17.00	\$17.00
5547/47WDC Top Plate	100316	-	\$132.00	-	-	-	-
5547 Soffit Latch Mounting Pkg	900502	-	\$12.00	-	-	-	-
5547-F Plunger Release Bracket	900576	.[Finish]	-	\$88.00	\$88.00	\$88.00	\$88.00
5547-F Flush Transom Release Brkt w/Screws	900614	.[Finish]	-	\$130.00	\$130.00	\$130.00	\$130.00
5547-F Top Latch Release Screws Pkg/20	PKGSRV.1018	-	\$14.00	-	-	-	-

VERTICAL RODS

Description	Specify		Non-Finished	613, 626	612	606	605, 625, 693
	Part number	Finish					
5547 Top Rod Kit 6'8"-8' Door	050053	-	\$421.00	-	-	-	-
5547-F Top Rod Kit 6'8"-8' Door	050457	.[Finish]	-	\$421.00	\$421.00	\$421.00	\$421.00
5547WDC Top Rod Kit 6'8"-8' Door	050110	-	\$421.00	-	-	-	-
ES5547 Top Latch/Rod Serv Kit	050656	-	\$475.00	-	-	-	-
5547 Top Rod Kit 8'-10' Door	050372	-	\$448.00	-	-	-	-
5547-F Top Rod Kit 8'-10' Door	050373	.[Finish]	-	\$448.00	\$448.00	\$448.00	\$448.00
5547WDC Top Rod Kit 8'-10' Door	050374	-	\$448.00	-	-	-	-
5547 Bottom Rod Kit	050036	-	\$421.00	-	-	-	-
5547-F Bottom Rod Kit	050458	-	\$421.00	-	-	-	-
5547WDC Bottom Rod Kit	050096	-	\$421.00	-	-	-	-
5547 Extension Rod Kit 8'-10' Door	051704	-	\$31.00	-	-	-	-
5547-F Extension Rod Kit 8'-10' Door	051705	-	\$31.00	-	-	-	-
5547WDC Extension Rod Kit 8'-10' Door	051707	-	\$31.00	-	-	-	-
5547 Extension Rod Kit 10'-12' Door	050631	-	\$102.00	-	-	-	-
5547-F Extension Rod Kit 10'-12' Door	050634	-	\$215.00	-	-	-	-
5547WDC Extension Rod Kit 10'-12' Door	050639	-	\$224.00	-	-	-	-
5547 Extension Rod Kit 12'-14' Door	050632	-	\$102.00	-	-	-	-
5547-F Extension Rod Kit 12'-14' Door	050635	-	\$215.00	-	-	-	-
5547WDC Extension Rod Kit 12'-14' Door	050640	-	\$224.00	-	-	-	-

PARTS AND ACCESSORIES

605	606	611	612	613	619	622	625	626	626AM	628	629
US3	US4	US9	US10	US10B	US15	US19	US26	US26D	US26DAM	US28	US32
630	630AM	643e	689	691	693	695	706	710	711	721	728
US32D	US32DAM	-	SP28	SP10	SPBLK	SP313	SP4	313	315	US3A	US4A

VERTICAL RODS

Description	Specify		Non-Finished	613, 626	612	606	605, 625, 693
	Part number	Finish					
5547 Extension Rod Kit 14'-16' Door	050633	-	\$102.00	-	-	-	-
5547-F Extension Rod Kit 14'-16' Door	050636	-	\$215.00	-	-	-	-
5547WDC Extension Rod Kit 14'-16' Door	050641	-	\$224.00	-	-	-	-
5547 Rod Control Housing	050367	-	\$383.00	-	-	-	-
5547 Top Rod Connector w/Pin	050368	-	\$51.00	-	-	-	-
5547 Bottom Rod Connector w/Pin	050369	-	\$48.00	-	-	-	-
5547-F Rod Guide Mounting Screws Pkg/10	090018	-	\$12.00	-	-	-	-
5547 Rod Connector Pin Pkg/2	090030	-	\$15.00	-	-	-	-
5547 Top Rod 1/8 x 5/8 Roll Pin Pkg/10	090032	-	\$12.00	-	-	-	-
5547WDC Latch Control	100315	-	\$408.00	-	-	-	-
5547-F Bottom Guide Package	100741	-	\$90.00	-	-	-	-
5547-F Rod Guide Package	105144	-	\$17.00	-	-	-	-
5547-F Rod Set Mounting Package	900541	-	\$12.00	-	-	-	-

88 SERIES

605	606	611	612	613	619	622	625	626	626AM	628	629
US3	US4	US9	US10	US10B	US15	US19	US26	US26D	US26DAM	US28	US32
630	630AM	643e	689	691	693	695	706	710	711	721	728
US32D	US32DAM	-	SP28	SP10	SPBLK	SP313	SP4	313	315	US3A	US4A

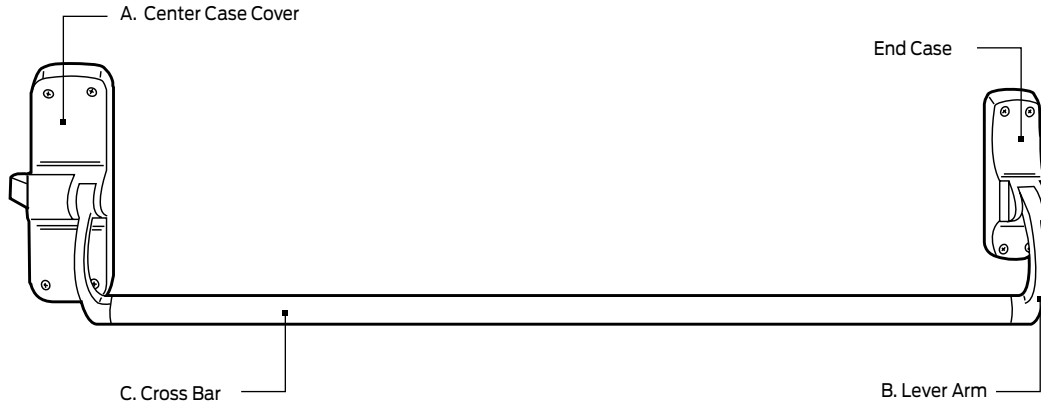

STANDARD FINISHES				
COLOR	US NUMBER	BHMA NUMBER	A, B, D	C - CROSS BAR FINISHES
Bright Brass	US3	605	Buffed Brass, Clear Coat	Buffed Brass, Clear Coat
Satin Brass	US4	606	Satin Brass, Clear Coat	Satin Brass, Clear Coat
Satin Bronze	US10	612	Plated/ Anodized	Satin Bronze US10
Satin Bronze, Oil-Rubbed	US10B	613	Oil-Rubbed	Oil Rubbed, US10B, 613
Polished Chrome	US26	625	Plated	Bright Stainless Steel US32, 629
Satin Chrome	US26D	626	Plated	Satin Stainless Steel US32D, 630
Black	SPBLK	693	Powder Coat	Powder Coat, SPBLK, 693
Aged Bronze	643E	-	Aged Bronze, Relieved	Aged Bronze, no Relief

SPECIAL FINISHES				
COLOR	US NUMBER	BHMA NUMBER	A, B, D	C - TOUCH BAR TRIM FINISHES
Bright Brass- no Lacquer	US3A	721	Buffed Brass	Bright Brass US3A
Satin Brass- no Lacquer	US4A	728	Satin Brass	Satin Brass US4A
Satin Chrome - Antimicrobial	US26D-AM	626-AM	AM Clear over Plated	AM - Clear over Satin Stainless Steel

Note: On a fire device "A" = Stainless Steel Substrate

88 SERIES SEX BOLT QUANTITIES		
APPLICATION	425 SEX BOLTS (OPTIONAL)	FOR COMPOSITE OR WOOD FIRE DOORS 425 SEX BOLTS(SUPPLIED)
88 or 8875 with Trim	4	4
88 or 8875 EO (exit device only)	8	8
8827 with trim	12	12
8827 EO (exit device only)	16	16
8847	4	4

88 SERIES

605	606	611	612	613	619	622	625	626	626AM	628	629
US3	US4	US9	US10	US10B	US15	US19	US26	US26D	US26DAM	US28	US32
630	630AM	643e	689	691	693	695	706	710	711	721	728
US32D	US32DAM	-	SP28	SP10	SPBLK	SP313	SP4	313	315	US3A	US4A

TYPE OF DEVICE							
88 Rim	8827 Surface Vertical Rod	8847 Concealed Vertical Rod	8875 Mortise Lock				
FUNCTION							
DT: Dummy Trim	EO: Exit Only	K: Knob	KBE: Knob Blank Escutcheon				
KDT: Knob Dummy	KNL: Knob Night Latch	L: Lever-06 Standard	LDT: Lever, Dummy Trim				
LBE: Lever, Blank Escutcheon	NL: Night Latch, Key Retracts	NLOP: Night Latch, Opt. Pull	TL: Turn Lever				
TLBE: Turn Lever, Blank Escutcheon	TLOP: Turn Lever, Opt. Pull	TP: Thumbpiece	TPBE: Thumbpiece - Blank Escutcheon				
TPNL: Thumbpiece - Night Latch							
RATING							
None: Panic Exit Device		- F: Fire Exit Device					
DEVICE FINISH							
605: Bright Brass (US3)	721: Bright Brass - No Lacquer (US3A)	606: Satin Brass (US4)	728: Satin Brass - No Lacquer (US4A)				
612: Satin Bronze (US10)	613: Satin Bronze-Oil Rubbed (US10B)	625: Bright Chrome (US26)	626: Satin Chrome (US26D)				
711: Black (315)							
DEVICE HANDING							
RHR: Right Hand Reverse		LHR: Left Hand Reverse					
TRIM / CONTROL TRIM							
LC: Less Control	LT: Less Trim	110MD / 110WD: Standard on NL-OP	216D: Cylinder Anchor				
371: Lever - 8847-F	373: Lever - 88 Rim, 8827 / 8875	376T: Thumbturn Control -CV	377T: Thumbturn - 8827				
606/608: Optional Trim	880: Standard Trim	880SA: Standard Vertical Surface Applied	880WDF: Standard 88-F Rim wood / composite door				
CONTROL LEVER STYLES 06 LEVER STANDARD							
Standard levers:	01	02	03	06	07	12	17
Knurled levers:	03K	06K					
TRIM / CONTROL FINISH							
605: Bright Brass (US3)	721: Bright Brass - no Lacquer (US3A)	606: Satin Brass (US4)	728: Satin Brass - no Lacquer (US4A)				
612: Satin Bronze (US10)	613: Satin Bronze-Oil Rubbed (US10B)	625: Bright Chrome(US26)	626: Satin Chrome (US26D)				
693: Painted Black (SPBLK)							
MORTISE LOCK E7500							
LL: Less Lock	7500: Standard Mortise	E7500: Electric Unlocking					

88 SERIES

605	606	611	612	613	619	622	625	626	626AM	628	629
US3	US4	US9	US10	US10B	US15	US19	US26	US26D	US26DAM	US28	US32
630	630AM	643e	689	691	693	695	706	710	711	721	728
US32D	US32DAM	-	SP28	SP10	SPBLK	SP313	SP4	313	315	US3A	US4A

MORTISE LOCK FINISH

605: Bright Brass (US3)	721: Bright Brass - no Lacquer (US3A)	606: Satin Brass (US4)	728: Satin Brass - no Lacquer (US4A)
612: Satin Bronze (US10)	613: Satin Bronze-Oil Rubbed (US10B)	630: Satin Stainless (US32D)	693: Painted Black (SPBLK)
622: Matte Black (US19)	629: Bright Stainless Steel (US32)		

RODS FOR SURFACE / CONCEALED VERTICAL DEVICES ONLY

OPR: One piece top rod	LBR: Less Bottom Rod	RG-27: Rod / Latch Guard	RGO: Rod Guard Only
------------------------	----------------------	--------------------------	---------------------

SWITCH OPTIONS

RX : Request to Exit

ELECTRIC LOCKING

E: Electric Locking

STORM RATING

HH: Hurricane device

STRIKE SERIES

LS: Less Strike	LTS: Less Top Strike	1409: Optional 88 Rim	1410: Optional Rim
1606: Optional Rim	1609: Optional Rim	1610: Optional Rim	268: Standard 88 Fire
299: Standard 88 Rim	575-2: Optional 8875 Mortise	575: Standard 8875 Mortise	576A: Optional. 8875 1-3/4
576B: Optional 8875 2-1/4			

BOTTOM STRIKE SERIES

LBS (Less Bottom Strike)	248L-4 (Surface)	301L / 304L (Mortise)	385A (Adjustable Mortise)
--------------------------	------------------	-----------------------	---------------------------

STRIKE FINISH

605: Bright Brass (US3)	606: Satin Brass (US4)	612: Satin Bronze (US10)	613: Satin Bronze-Oil Rubbed (US10B)
622: Matte Black (US19)	625: Bright Chrome (US26)	626: Satin Chrome (US26D)	629: Bright Stainless (US32)
630: Satin Stainless (US32D)	695: Duranodic Dark Bronze (313)	MD (e-Moly)	

CROSS BAR OPTIONS

RCB: Reinforced Crossbar	KN: Knurled
--------------------------	-------------

MISC DEVICE OPTIONS

10WDA: #10WDA Cover Plate	CYL: Include Cylinder	FL: 8847-F Device	FL: 8827-F, not UL Fire application
LCP: Less Cover Plate	PL: Include Pullman Latch)	SNB: Include # of Sex Bolts	889R /889M /889V: 373L with Sexbolts Cover Plates

SLM BLOCKING

SLM: SLM Blocking

88 SERIES

605	606	611	612	613	619	622	625	626	626AM	628	629
US3	US4	US9	US10	US10B	US15	US19	US26	US26D	US26DAM	US28	US32
630	630AM	643e	689	691	693	695	706	710	711	721	728
US32D	US32DAM	-	SP28	SP10	SPBLK	SP313	SP4	313	315	US3A	US4A

SECURITY SCREWS

SEC: Include Security Screws

DOOR MATERIAL

ALD: Aluminum door

CP: Composite door

HMD: Hollow metal

WD: Wood door

DOOR THICKNESS

DT1-3/4: 1-3/4" Standard

DT2: 2" thickness

DT2-1/4: 2-1/4" thickness

DOOR APPLICATION

DE: Pair Double egress doors

PR: Pair of doors

SGL: Single door

MSV / MCV (Mortise Surface / Concealed Vert.)

88 SERIES

605	606	611	612	613	619	622	625	626	626AM	628	629
US3	US4	US9	US10	US10B	US15	US19	US26	US26D	US26DAM	US28	US32
630	630AM	643e	689	691	693	695	706	710	711	721	728
US32D	US32DAM	-	SP28	SP10	SPBLK	SP313	SP4	313	315	US3A	US4A

Rim devices

ACN							PRICE BASED ON FINISH						Default trim, included
Device type	Function	Fire	Finish	Device size	Handing	Lever design	626	613	612	606	605 619 625 643E	693	
							3' DEVICE PRICING SHOWN. 4' ADD \$19.00 LIST						
EXIT HARDWARE							3' DEVICE PRICING SHOWN. 4' ADD \$19.00 LIST						
88	. EO ²	.	[]	.	[]		\$1,556	\$1,760	\$1,567	\$1,480	\$1,905	\$1,905	N/A
88	. DT	.	[]	.	[]		\$1,835	\$2,059	\$1,929	\$1,695	\$2,267	\$2,267	880DT-R
88	. NL	.	[]	.	[]	[]	\$1,853	\$2,077	\$1,947	\$1,713	\$2,285	\$2,285	880NL-R [⊕]
88	. TP	.	[]	.	[]		\$1,867	\$2,091	\$2,001	\$1,776	\$2,339	\$2,339	880TP-R
88	. TP-BE	.	[]	.	[]		\$1,867	\$2,091	\$2,001	\$1,776	\$2,339	\$2,339	880TP-BE-R
88	. K	.	[]	.	[]		\$1,919	\$2,149	\$2,028	\$1,776	\$2,366	\$2,366	880K-R
88	. K-BE	.	[]	.	[]		\$1,919	\$2,149	\$2,028	\$1,776	\$2,366	\$2,366	880K-BE-R
88	. K-DT	.	[]	.	[]		\$1,919	\$2,149	\$2,028	\$1,776	\$2,366	\$2,366	880K-DT-R
88	. K-NL	.	[]	.	[]		\$1,919	\$2,149	\$2,028	\$1,776	\$2,366	\$2,366	880K-NL-R
88	. L	.	[]	.	[]	[]	\$2,284	\$2,478	\$2,295	\$2,095	\$2,712	\$2,623	373L ¹
88	. L-BE	.	[]	.	[]	[]	\$2,245	\$2,439	\$2,256	\$2,056	\$2,673	\$2,584	373L-BE ¹
88	. L-DT	.	[]	.	[]	[]	\$2,225	\$2,419	\$2,236	\$2,036	\$2,653	\$2,564	373L-DT ¹
FIRE EXIT HARDWARE							3' DEVICE PRICING SHOWN. 4' ADD \$19.00 LIST						
88	. EO ²	. F	[]	.	[]		\$1,933	\$2,137	\$1,944	\$1,857	\$2,282	\$2,282	N/A
88	. DT	. F	[]	.	[]		\$2,212	\$2,436	\$2,306	\$2,072	\$2,644	\$2,644	880DT-R
88	. NL	. F	[]	.	[]	[]	\$2,230	\$2,454	\$2,324	\$2,090	\$2,662	\$2,662	880NL-R [⊕]
88	. TP	. F	[]	.	[]		\$2,244	\$2,468	\$2,378	\$2,153	\$2,716	\$2,716	880TP-R
88	. TP-BE	. F	[]	.	[]		\$2,244	\$2,468	\$2,378	\$2,153	\$2,716	\$2,716	880TP-BE-R
88	. K	. F	[]	.	[]		\$2,296	\$2,526	\$2,405	\$2,153	\$2,743	\$2,743	880K-R
88	. K-BE	. F	[]	.	[]		\$2,296	\$2,526	\$2,405	\$2,153	\$2,743	\$2,743	880K-BE-R
88	. K-NL	. F	[]	.	[]		\$2,296	\$2,526	\$2,405	\$2,153	\$2,743	\$2,743	880K-NL-R
88	. L	. F	[]	.	[]	[]	\$2,661	\$2,855	\$2,672	\$2,472	\$3,089	\$3,000	373L ¹
88	. L-BE	. F	[]	.	[]	[]	\$2,622	\$2,816	\$2,633	\$2,433	\$3,050	\$2,961	373L-BE ¹

[⊕] Consult factory for lead time.

¹ Composite Doors - 889 cover plate is required for sex bolt applications using 373 lever controls and will be supplied at an additional price. Refer to page 159 for price by finish.

² Cylinder Plate for NLOP function - included with EO device.

88-F Rim and all devices specified with lever trim are handed and not field reversible, specify handing RHR or LHR.

DEFAULT ATTRIBUTES

Pricing includes default options shown below. Additional options and configurations available.

Cylinders:	Sex bolts	Door thickness	Center line
Not included	Not included	1-3/4"	39-13/16"

Strike(s):

- Exit hardware:
- Includes 299 strike
- Fire exit hardware:
- Includes 268 strike

88 SERIES

Surface vertical rod devices (27)

605	606	611	612	613	619	622	625	626	626AM	628	629
US3	US4	US9	US10	US10B	US15	US19	US26	US26D	US26DAM	US28	US32
630	630AM	643e	689	691	693	695	706	710	711	721	728
US32D	US32DAM	-	SP28	SPI0	SPBLK	SP313	SP4	313	315	US3A	US4A

ACN							PRICE BASED ON FINISH					Default trim, included	
Device type	Function	Fire	Finish	Device size	Handing	Lever design	605 [Ⓢ]	619 [Ⓢ]	625	643E	693 [Ⓢ]		
EXIT HARDWARE							3' DEVICE PRICING SHOWN. 4' ADD \$19.00 LIST						
8827	. EO	. []	. []				\$2,173	\$2,319	\$2,081	\$1,976	\$2,553	\$2,553	N/A
8827	. DT	. []	. []				\$2,452	\$2,618	\$2,443	\$2,191	\$2,915	\$2,915	880DT-V/M
8827	. TP	. []	. []				\$2,484	\$2,650	\$2,515	\$2,272	\$2,987	\$2,987	880TP-V
8827	. TP-BE	. []	. []				\$2,484	\$2,650	\$2,515	\$2,272	\$2,987	\$2,987	880TP-BE-V
8827	. TP-NL	. []	. []	. []			\$2,484	\$2,650	\$2,515	\$2,272	\$2,987	\$2,987	880TP-V [Ⓢ]
8827	. K	. []	. []				\$2,536	\$2,708	\$2,542	\$2,272	\$3,014	\$3,014	880K-V
8827	. K-BE	. []	. []				\$2,536	\$2,708	\$2,542	\$2,272	\$3,014	\$3,014	880K-BE-V
8827	. K-DT	. []	. []				\$2,536	\$2,708	\$2,542	\$2,272	\$3,014	\$3,014	880K-DT-V
8827	. K-NL	. []	. []				\$2,536	\$2,708	\$2,542	\$2,272	\$3,014	\$3,014	880K-V
8827	. L	. []	. []	. []	. []		\$2,901	\$3,037	\$2,809	\$2,591	\$3,360	\$3,271	373L ¹
8827	. L-BE	. []	. []	. []	. []		\$2,862	\$2,998	\$2,770	\$2,552	\$3,321	\$3,232	373L-BE ¹
8827	. L-DT	. []	. []	. []	. []		\$2,842	\$2,978	\$2,750	\$2,532	\$3,301	\$3,212	373L-DT ¹
8827	. TL	. []	. []				\$3,235	\$3,401	\$3,286	\$2,866	\$3,758	\$3,698	880DT-V/M/377T ²
8827	. TL-BE	. []	. []				\$3,191	\$3,357	\$3,242	\$2,822	\$3,714	\$3,654	880DT-V/M/377T-BE ²
FIRE EXIT HARDWARE							3' DEVICE PRICING SHOWN. 4' ADD \$19.00 LIST						
8827	. EO	. F	. []	. []			\$2,937	\$3,083	\$2,845	\$2,740	\$3,317	\$3,317	N/A
8827	. DT	. F	. []	. []			\$3,216	\$3,382	\$3,207	\$2,955	\$3,679	\$3,679	880DT-V/M
8827	. TP	. F	. []	. []			\$3,248	\$3,414	\$3,279	\$3,036	\$3,751	\$3,751	880TP-V
8827	. TP-BE	. F	. []	. []			\$3,248	\$3,414	\$3,279	\$3,036	\$3,751	\$3,751	880TP-V
8827	. TP-NL	. F	. []	. []	. []		\$3,248	\$3,414	\$3,279	\$3,036	\$3,751	\$3,751	880TP-BE-V
8827	. K	. F	. []	. []			\$3,300	\$3,472	\$3,306	\$3,036	\$3,778	\$3,778	880K-V
8827	. K-BE	. F	. []	. []			\$3,300	\$3,472	\$3,306	\$3,036	\$3,778	\$3,778	880K-BE-V
8827	. K-NL	. F	. []	. []			\$3,300	\$3,472	\$3,306	\$3,036	\$3,778	\$3,778	880K-V
8827	. L	. F	. []	. []	. []		\$3,665	\$3,801	\$3,573	\$3,355	\$4,124	\$4,035	373L ¹
8827	. L-BE	. F	. []	. []	. []		\$3,626	\$3,762	\$3,534	\$3,316	\$4,085	\$3,996	373L-BE ¹
8827	. TL	. F	. []	. []	. []		\$3,999	\$4,165	\$4,050	\$3,630	\$4,522	\$4,462	880DT-V/M/377T ²
8827	. TL-BE	. F	. []	. []	. []		\$3,955	\$4,121	\$4,006	\$3,586	\$4,478	\$4,418	880DT-V/M/377T-BE ²

[Ⓢ] Consult factory for lead time.

¹ Composite Doors - 889 cover plate is required for sex bolt applications using 373 lever controls and will be supplied at an additional price. Refer to page 159 for price by finish.

² Wood Doors - 10WDA cover plate is required for the 370 series controls and will be supplied at an additional, \$56 list add.

Handing - Lever trim is handed and not field reversible, specify handing RHR or LHR.

DEFAULT ATTRIBUTES

Pricing includes default options shown below. Additional options and configurations available.

Cylinders:	Sex bolts	Door thickness	Center line
Not included	Not included	1-3/4"	39-13/16"

Strike(s):

Exit hardware:

- Includes 299, 248L-4 and 304L strikes

Fire exit hardware:

- Includes 304L strike

88 SERIES

605	606	611	612	613	619	622	625	626	626AM	628	629
US3	US4	US9	US10	US10B	US15	US19	US26	US26D	US26DAM	US28	US32
630	630AM	643e	689	691	693	695	706	710	711	721	728
US32D	US32DAM	-	SP28	SP10	SPBLK	SP313	SP4	313	315	US3A	US4A

Concealed vertical rod devices (47)

ACN							PRICE BASED ON FINISH						Default trim, included
Device type	Function	Fire	Finish	Device size	Handing	Lever design	626	613	612	606 [Ⓢ]	605 [Ⓢ] 619 [Ⓢ] 625 643E	693 [Ⓢ]	
FIRE EXIT HARDWARE							3' DEVICE PRICING SHOWN. 4' ADD \$19.00 LIST						
8847	. EO	. F	. []	. []			\$2,694	\$2,840	\$2,602	\$2,497	\$3,074	\$3,074	N/A
8847	. L	. F	. []	. []	. []	. []	\$3,476	\$3,612	\$3,384	\$3,166	\$3,935	\$3,846	371L
8847	. L-BE	. F	. []	. []	. []	. []	\$3,440	\$3,576	\$3,348	\$3,130	\$3,899	\$3,810	371L-BE
8847	. TL	. F	. []	. []	. []	. []	\$3,755	\$3,921	\$3,806	\$3,386	\$4,278	\$4,218	880DT-V-SA/376T ²
8847	. TL-BE	. F	. []	. []	. []	. []	\$3,712	\$3,878	\$3,763	\$3,343	\$4,235	\$4,175	880DT-V-SA/376T-BE ²

[Ⓢ] Consult factory for lead time.

¹ Wood Doors - 10WDA cover plate is required for the 370 series controls and will be supplied at an additional, \$56 list add.

Handing - 8847-F and all devices specified with lever trim are handed and not field reversible, specify handing RHR or LHR.

Dogging - 8847-F device is available with dogging less fire label at no additional charge. Specify 8847-F with dogging. Consult factory for lead time.

DEFAULT ATTRIBUTES

Pricing includes default options shown below. Additional options and configurations available.

Cylinders:	Sex bolts	Door thickness	Center line
Not included	Not included	1-3/4"	39-13/16"

Strike(s):

Fire exit hardware:

- Hollow metal doors only
- Includes 301L strike

88 SERIES

Mortise lock devices (75)

605	606	611	612	613	619	622	625	626	626AM	628	629
US3	US4	US9	US10	US10B	US15	US19	US26	US26D	US26DAM	US28	US32
630	630AM	643e	689	691	693	695	706	710	711	721	728
US32D	US32DAM	-	SP28	SP10	SPBLK	SP313	SP4	313	315	US3A	US4A

ACN							PRICE BASED ON FINISH					Default trim, included	
Device type	Function	Fire	Finish	Device size	Handing	Lever design	626	613	612	606 [Ⓢ]	605 [Ⓢ] 619 [Ⓢ] 625 643E		693 [Ⓢ]
EXIT HARDWARE							3' DEVICE PRICING SHOWN. 4' ADD \$19.00 LIST						
8875	. EO	. []	. []				\$2,070	\$2,533	\$2,131	\$2,046	\$2,442	\$2,442	N/A
8875	. DT	. []	. []				\$2,349	\$2,832	\$2,493	\$2,261	\$2,804	\$2,804	880DT-V/M
8875	. NL	. []	. []	. []			\$2,367	\$2,850	\$2,511	\$2,279	\$2,822	\$2,822	880NL-M [Ⓢ]
8875	. TP	. []	. []				\$2,381	\$2,864	\$2,565	\$2,342	\$2,876	\$2,876	880TP-M
8875	. TP-BE	. []	. []				\$2,381	\$2,864	\$2,565	\$2,342	\$2,876	\$2,876	880TP-BE-M
8875	. K	. []	. []				\$2,433	\$2,922	\$2,592	\$2,342	\$2,903	\$2,903	880K-M
8875	. K-BE	. []	. []				\$2,433	\$2,922	\$2,592	\$2,342	\$2,903	\$2,903	880K-BE-M
8875	. K-DT	. []	. []				\$2,433	\$2,922	\$2,592	\$2,342	\$2,903	\$2,903	880K-DT-M
8875	. L	. []	. []	. []	. []		\$2,798	\$3,251	\$2,859	\$2,661	\$3,249	\$3,160	373L ¹
8875	. L-BE	. []	. []	. []	. []		\$2,759	\$3,212	\$2,820	\$2,622	\$3,210	\$3,121	373L-BE ¹
8875	. L-DT	. []	. []	. []	. []		\$2,739	\$3,192	\$2,800	\$2,602	\$3,190	\$3,101	373L-DT ¹
FIRE EXIT HARDWARE							3' DEVICE PRICING SHOWN. 4' ADD \$19.00 LIST						
8875	. EO	. F	. []	. []			\$2,260	\$2,723	\$2,321	\$2,236	\$2,632	\$2,632	N/A
8875	. DT	. F	. []	. []			\$2,539	\$3,022	\$2,683	\$2,451	\$2,994	\$2,994	880DT-V/M
8875	. NL	. F	. []	. []	. []		\$2,557	\$3,040	\$2,701	\$2,469	\$3,012	\$3,012	880NL-M
8875	. TP	. F	. []	. []			\$2,571	\$3,054	\$2,755	\$2,532	\$3,066	\$3,066	880TP-M
8875	. TP-BE	. F	. []	. []			\$2,571	\$3,054	\$2,755	\$2,532	\$3,066	\$3,066	880TP-BE-M
8875	. K	. F	. []	. []			\$2,623	\$3,112	\$2,782	\$2,532	\$3,093	\$3,093	880K-M
8875	. K-BE	. F	. []	. []			\$2,623	\$3,112	\$2,782	\$2,532	\$3,093	\$3,093	880K-BE-M
8875	. L	. F	. []	. []	. []		\$2,988	\$3,441	\$3,049	\$2,851	\$3,439	\$3,350	373L ¹
8875	. L-BE	. F	. []	. []	. []		\$2,949	\$3,402	\$3,010	\$2,812	\$3,400	\$3,311	373L-BE ¹

[Ⓢ] Consult factory for lead time.

¹ Composite Doors - 889 cover plate is required for sex bolt applications using 373 lever controls and will be supplied at an additional price. Refer to page 159 for price by finish.

Handing - 8875, 8875-F and all devices specified with lever trim are handed and not field reversible, specify handing RHR or LHR.

DEFAULT ATTRIBUTES

Pricing includes default options shown below. Additional options and configurations available.

Cylinders:	Sex bolts	Door thickness	Center line
Not included	Not included	1-3/4"	39-13/16"

Strike(s):

Exit hardware:

- Includes 575 strike

Fire exit hardware:

- Includes 575 strike

OPTIONS

605	606	611	612	613	619	622	625	626	626AM	628	629
US3	US4	US9	US10	US10B	US15	US19	US26	US26D	US26DAM	US28	US32
630	630AM	643e	689	691	693	695	706	710	711	721	728
US32D	US32DAM	-	SP28	SP10	SPBLK	SP313	SP4	313	315	US3A	US4A

SWITCHES	Specify (Prefix)	Price adjustment
Request to Exit - Crossbar monitor switch in end case <ul style="list-style-type: none"> Factory install only 	RX	\$266.00
PULLMAN LATCHES - Not for use with fire exit hardware	Specify	Price adjustment
8827-LBR with PL Top Latch, for use with e-strike. Shipped less label.	PL	\$120.00
ELECTRIC UNLOCKING	Specify (Prefix)	Price adjustment
<ul style="list-style-type: none"> Electric unlocking of outside lever for all 8875 mortise devices Available with 8875 mortise K, K-BE, L-BE, TP or TP-BE lever trim only For 24VAC installation a SO24 Rectifier Kit will be supplied at an additional \$45 list add. Specify FAIL SECURE (FSE) or FAIL SAFE (FS). SO rectifier kit intended for fail secure / momentary use only. Contact product support for assistance. 	E	\$661.00
<ul style="list-style-type: none"> Electric unlocking of outside 88 Series lever or thumbturn controls Available with 371L-BE, 373L-BE, 376T-BE, 377T-BE functions only 24VDC furnished standard Prefix Lever or Thumbturn Control with "E" Example: E371L-BE 		\$661.00
CROSSBAR OPTIONS	Specify (Prefix)	Price adjustment
Reinforced Crossbar	RCB	\$112.00
Knurled Crossbar (KN must be ordered as 4' device; cut bar as needed)	KN	\$130.00
FLUSH TRANSOM INSTALLATION	Specify (Prefix)	Price adjustment
8827-F Device (Not a UL Fire Exit Hardware listed application)	FL	\$426.00
8847-F Device		\$104.00

PARTS AND ACCESSORIES

605	606	611	612	613	619	622	625	626	626AM	628	629
US3	US4	US9	US10	US10B	US15	US19	US26	US26D	US26DAM	US28	US32
630	630AM	643e	689	691	693	695	706	710	711	721	728
US32D	US32DAM	-	SP28	SPI0	SPBLK	SP313	SP4	313	315	US3A	US4A

BACKPLATE CONVERSION KITS

Description	Specify		Non-Finished	613, 626	612	606	605, 625, 693
	Part number	Finish					
88CK-NL Converts TP,K to NL - Panic	050101	.[Finish]	-	\$60.00	\$62.00	\$56.00	\$64.00
88CK-TP Converts EO,DT,NL,K to TP - Panic	050102	.[Finish]	-	\$74.00	\$78.00	\$70.00	\$84.00
88CK-K/L Converts EO,DT,NL,TP to K or L - Panic	050103	.[Finish]	-	\$128.00	\$133.00	\$123.00	\$142.00
88CK-NL-F Converts TP,K to NL - Fire	050106	.[Finish]	-	\$68.00	\$69.00	\$66.00	\$70.00
88CK-TP-F Converts EO,DT,NL,K to TP - Fire	050107	.[Finish]	-	\$84.00	\$88.00	\$74.00	\$97.00
88CK-K/L-F Converts EO,DT,NL,TP to K or L - Fire	050108	.[Finish]	-	\$128.00	\$133.00	\$126.00	\$142.00
8827CK-TP Converts EO,DT,K to TP - Panic or Fire	050104	-	\$229.00	-	-	-	-
8827CK-K/L-K/L-F Converts EO,DT,TP to K or L - Panic or Fire	050200	-	\$228.00	-	-	-	-
8827CK-K-NL/K-NL-F	050201	-	\$255.00	-	-	-	-
8827CK-TP-NL/TP-NL-F	050202	-	\$231.00	-	-	-	-
8827CK-EO/DT/TL	050447	-	\$38.00	-	-	-	-

CENTER CASE KITS (INCLUDES MOUNTING SCREWS)

Description	Specify		Non-Finished	613, 626	612	606	605, 625, 693
	Part number	Finish					
88EO/DT/NL Rim Center Case Kit	050409	.[Finish]	-	\$746.00	\$781.00	\$627.00	\$815.00
88TP Rim Center Case Kit	050410	.[Finish]	-	\$746.00	\$781.00	\$627.00	\$815.00
88K/L RHR Center Case Kit	050411	.[Finish]	-	\$746.00	\$781.00	\$627.00	\$815.00
88K/L LHR Center Case Kit	050412	.[Finish]	-	\$746.00	\$781.00	\$627.00	\$815.00
8875 RHR Center Case Kit	050413	.[Finish]	-	\$599.00	\$615.00	\$499.00	\$654.00
8875 LHR Center Case Kit	050414	.[Finish]	-	\$599.00	\$615.00	\$499.00	\$654.00
8827EO/DT/TL Center Case Kit	050415	.[Finish]	-	\$395.00	\$404.00	\$368.00	\$433.00
8827TP Center Case Kit	050416	.[Finish]	-	\$525.00	\$537.00	\$458.00	\$547.00
8827K/L Center Case Kit	050417	.[Finish]	-	\$658.00	\$690.00	\$563.00	\$716.00
8827TP-NL Center Case Kit	050418	.[Finish]	-	\$525.00	\$537.00	\$458.00	\$547.00
8827K-NL Center Case Kit	050419	.[Finish]	-	\$658.00	\$690.00	\$563.00	\$716.00
8875-F RHR Center Case Kit	050420	.[Finish]	-	\$690.00	\$724.00	\$566.00	\$749.00
8875-F LHR Center Case Kit	050421	.[Finish]	-	\$690.00	\$724.00	\$566.00	\$749.00
8847-F RHR Center Case Kit	050422	.[Finish]	-	\$690.00	\$724.00	\$566.00	\$749.00
8847-F LHR Center Case Kit	050423	.[Finish]	-	\$690.00	\$724.00	\$566.00	\$749.00
88EO-F/NL-F RHR Center Case Kit	050424	.[Finish]	-	\$938.00	\$1,110.00	\$1,110.00	\$1,173.00
88EO-F/NL-F LHR Center Case Kit	050425	.[Finish]	-	\$938.00	\$1,110.00	\$1,110.00	\$1,173.00
88TP-F RHR Center Case Kit	050426	.[Finish]	-	\$972.00	\$1,152.00	\$1,152.00	\$1,218.00
88TP-F LHR Center Case Kit	050427	.[Finish]	-	\$972.00	\$1,152.00	\$1,152.00	\$1,218.00
88K/L-F RHR Center Case Kit	050428	.[Finish]	-	\$972.00	\$1,152.00	\$1,152.00	\$1,218.00
88K/L-F LHR Center Case Kit	050429	.[Finish]	-	\$972.00	\$1,152.00	\$1,152.00	\$1,218.00
8827EO-F/TL-F Center Case Kit	050430	.[Finish]	-	\$510.00	\$527.00	\$421.00	\$552.00
8827TP-F Center Case Kit	050431	.[Finish]	-	\$739.00	\$774.00	\$616.00	\$809.00
8827K/L-F Center Case Kit	050432	.[Finish]	-	\$776.00	\$812.00	\$654.00	\$848.00

PARTS AND ACCESSORIES

605	606	611	612	613	619	622	625	626	626AM	628	629
US3	US4	US9	US10	US10B	US15	US19	US26	US26D	US26DAM	US28	US32
630	630AM	643e	689	691	693	695	706	710	711	721	728
US32D	US32DAM	-	SP28	SP10	SPBLK	SP313	SP4	313	315	US3A	US4A

CENTER CASE KITS (INCLUDES MOUNTING SCREWS)

Description	Specify		Non-Finished	613, 626	612	606	605, 625, 693
	Part number	Finish					
8827TP-NL-F Center Case Kit	050433	.[Finish]	-	\$716.00	\$751.00	\$588.00	\$780.00
8827K-NL-F Center Case Kit	050434	.[Finish]	-	\$791.00	\$812.00	\$662.00	\$863.00

RETROFIT COVER PLATES (FOR FALCON XX AND CR ED600)

Description	Specify		Non-Finished	689, 695
	Part number	Finish		
Cover Plate Pkg, 88 MORT/SVR	953001	.[Finish]	-	\$37.00
Cover Plate Pkg, 88 RIM	953002	.[Finish]	-	\$37.00

CENTER CASE PARTS - RIM

Description	Specify		Non-Finished	613, 626	612	606	605, 625, 693
	Part number	Finish					
88 Thumpiece Lift Replacement Kit*	050019	-	\$84.00	-	-	-	-
88 Rim Auxiliary Backplate	050260	.[Finish]	-	\$54.00	\$57.00	\$54.00	\$57.00
88-F Master Cam RH	050273	-	\$74.00	-	-	-	-
88-F Master Cam LH	050274	-	\$74.00	-	-	-	-
88-F Auxiliary Bolt RH	050275	-	\$60.00	-	-	-	-
88-F Auxiliary Bolt LH	050276	-	\$60.00	-	-	-	-
88 Cylinder Anchor Plate	050331	-	\$13.00	-	-	-	-
88 Latchbolt w/Axle Kit	050497	-	\$86.00	-	-	-	-
88-F Latchbolt w/Axle Kit	050498	-	\$90.00	-	-	-	-
88 Rim Latch Retainer Plate	050499	-	\$14.00	-	-	-	-
88 Rim Latch Tail, Spring, Rivet Kit	050500	-	\$57.00	-	-	-	-
88 Rim Latch Tail Spring Pkg/10	050393	-	\$13.00	-	-	-	-
88 Rim Master Cam	050501	-	\$31.00	-	-	-	-
88NL Cylinder Cam	050502	-	\$34.00	-	-	-	-
88NL-F Cylinder Cam	050503	-	\$31.00	-	-	-	-
88K/L-F Knob Cam Lift	050504	-	\$51.00	-	-	-	-
88K/L-F Cylinder Cam	050505	-	\$31.00	-	-	-	-
88K/L-F Knob Cam Bracket	050506	-	\$104.00	-	-	-	-
88TP/-F Cylinder Cam	050508	-	\$17.00	-	-	-	-
88 Rim Latch Bolt Axle Pkg/4	090001	-	\$14.00	-	-	-	-
88 Rim Center Case Rivet Pkg/10	090002	-	\$14.00	-	-	-	-
88-F Rim Gravity Dog Spring Pkg/5	090009	-	\$14.00	-	-	-	-
88K/L-F Retaining Ring Pkg/10	090015	-	\$14.00	-	-	-	-
88-F Auxiliary Bolt Return Spring Pkg/5	090017	-	\$14.00	-	-	-	-

* For 88TP/TP-F devices shipped after June 2000. For devices shipped before June 2000, replace 050102 for 88TP or 050107 for 88TP-F.

PARTS AND ACCESSORIES

605	606	611	612	613	619	622	625	626	626AM	628	629
US3	US4	US9	US10	US10B	US15	US19	US26	US26D	US26DAM	US28	US32
630	630AM	643e	689	691	693	695	706	710	711	721	728
US32D	US32DAM	-	SP28	SP10	SPBLK	SP313	SP4	313	315	US3A	US4A

CENTER CASE PARTS - RIM

Description	Specify		Non-Finished	613, 626	612	606	605, 625, 693
	Part number	Finish					
Hex Socket Wrench 5/32"	113853	-	\$11.00	-	-	-	-
88 C/C or E/C Mtg Pkg (CS and MS)	900503	.[Finish]	-	\$15.00	\$15.00	\$15.00	\$15.00
88 C/C or E/C Mtg Pkg (CS Screws)	900504	.[Finish]	-	\$14.00	\$14.00	\$14.00	\$14.00
88 C/C or E/C Mtg Pkg (MS Scr 1-3/4" Dr)	900505	.[Finish]	-	\$13.00	\$13.00	\$13.00	\$13.00
88 C/C or E/C Mtg Pkg (MS Scr 2-1/4" Dr)	900506	.[Finish]	-	\$13.00	\$13.00	\$13.00	\$13.00
88 Rim Latch Retainer Plate Screw Pkg/10	900610	-	\$14.00	-	-	-	-
88 Backplate Screw Pkg/4	900613	-	\$14.00	-	-	-	-

* For 88TP/TP-F devices shipped after June 2000. For devices shipped before June 2000, replace 050102 for 88TP or 050107 for 88TP-F.

CENTER CASE PARTS - SURFACE VERTICAL

Description	Specify		Non-Finished	613, 626	612	606	605, 625, 693
	Part number	Finish					
88 Cylinder Anchor Plate	050331	-	\$13.00	-	-	-	-
8827/27-F Rod Control	050446	-	\$104.00	-	-	-	-
8827K/K-NL/TP/TP-NL/-F Cylinder Cam	050448	-	\$31.00	-	-	-	-
8827K/K-NL/-F Knob Hub	050449	-	\$115.00	-	-	-	-
8827K-NL/TP-NL Backplate Pin Pkg/2	090012	-	\$25.00	-	-	-	-
8827/27-F Rod Control Pin Pkg/2	090016	-	\$14.00	-	-	-	-
88 C/C or E/C Mtg Pkg (CS and MS)	900503	.[Finish]	-	\$15.00	\$15.00	\$15.00	\$15.00
88 C/C or E/C Mtg Pkg (CS Screws)	900504	.[Finish]	-	\$14.00	\$14.00	\$14.00	\$14.00
88 C/C or E/C Mtg Pkg (MS Scr 1-3/4" Dr)	900505	.[Finish]	-	\$13.00	\$13.00	\$13.00	\$13.00
88 C/C or E/C Mtg Pkg (MS Scr 2-1/4" Dr)	900506	.[Finish]	-	\$13.00	\$13.00	\$13.00	\$13.00
8827 Backplate Screw Pkg	900615	-	\$14.00	-	-	-	-

CENTER CASE PARTS - CONCEALED VERTICAL/MORTISE

Description	Specify		Non-Finished	613, 626	612	606	605, 625, 693
	Part number	Finish					
8847-F/75/75-F Latch Control LH	050209	-	\$207.00	-	-	-	-
8847-F/75/75-F Latch Control RH	050210	-	\$207.00	-	-	-	-
8847-F/75/75-F Backplate w/Screws	050211	-	\$17.00	-	-	-	-
88 Cylinder Anchor Plate	050331	-	\$13.00	-	-	-	-
8847/75-F Flat Point Set Screw Pkg/5	090013	-	\$16.00	-	-	-	-
8847-F/75/75-F C/Case Spring Pkg/2	090014	-	\$14.00	-	-	-	-
88 C/C or E/C Mtg Pkg (CS and MS)	900503	.[Finish]	-	\$15.00	\$15.00	\$15.00	\$15.00
88 C/C or E/C Mtg Pkg (CS Screws)	900504	.[Finish]	-	\$14.00	\$14.00	\$14.00	\$14.00
88 C/C or E/C Mtg Pkg (MS Scr 1-3/4" Dr)	900505	.[Finish]	-	\$13.00	\$13.00	\$13.00	\$13.00
88 C/C or E/C Mtg Pkg (MS Scr 2-1/4" Dr)	900506	.[Finish]	-	\$13.00	\$13.00	\$13.00	\$13.00
8827 Backplate Screw Pkg	900615	-	\$14.00	-	-	-	-

PARTS AND ACCESSORIES

605	606	611	612	613	619	622	625	626	626AM	628	629
US3	US4	US9	US10	US10B	US15	US19	US26	US26D	US26DAM	US28	US32
630	630AM	643e	689	691	693	695	706	710	711	721	728
US32D	US32DAM	-	SP28	SPIO	SPBLK	SP313	SP4	313	315	US3A	US4A

CROSSBARS

Description	Specify		Non-Finished	613, 626	612	606	605, 625, 693
	Part number	Finish					
42" Standard Crossbar Kit	050004	.[Finish]	-	\$242.00	\$248.00	\$242.00	\$255.00
42" Knurled Crossbar Kit	050005	.[Finish]	-	\$390.00	\$396.00	\$390.00	\$420.00
37" Crossbar Reinforcement Kit	050459	-	\$131.00	-	-	-	-

END CASE

Description	Specify		Non-Finished	613, 626	612	606	605, 625, 693
	Part number	Finish					
88 R/M/V End Case Kit	050435	.[Finish]	-	\$255.00	\$277.00	\$216.00	\$293.00
8827-F/8875-F/8847-F End Case Kit	050436	.[Finish]	-	\$345.00	\$359.00	\$291.00	\$384.00
88-F Rim End Case Kit	050437	.[Finish]	-	\$302.00	\$326.00	\$255.00	\$354.00
88 RX Subminiature Switch	968938	-	\$35.00	-	-	-	-
88 End Case Spring Pkg/10	090080	-	\$57.00	-	-	-	-
88 End Case Spring Pkg/2	090003	-	\$15.00	-	-	-	-
88 End Case Spring Stop Kit	050451	-	\$17.00	-	-	-	-
88-F End Case Spring Stop Kit	050452	-	\$17.00	-	-	-	-
88/88-F End Case Spring Tube	050476	-	\$14.00	-	-	-	-
88/88-F Spring Tube Bracket w/Screws Kit	050477	-	\$14.00	-	-	-	-
88 C/C or E/C Mtg Pkg (CS and MS)	900503	.[Finish]	-	\$15.00	\$15.00	\$15.00	\$15.00
88 C/C or E/C Mtg Pkg (CS Screws)	900504	.[Finish]	-	\$14.00	\$14.00	\$14.00	\$14.00
88 C/C or E/C Mtg Pkg (MS Scr 1-3/4" Dr)	900505	.[Finish]	-	\$13.00	\$13.00	\$13.00	\$13.00
88 C/C or E/C Mtg Pkg (MS Scr 2-1/4" Dr)	900506	.[Finish]	-	\$13.00	\$13.00	\$13.00	\$13.00

LEVER ARMS

Description	Specify		Non-Finished	613, 626	612	606	605, 625, 693
	Part number	Finish					
88 R/M/V RH Lever Arm Kit	050438	.[Finish]	-	\$202.00	\$212.00	\$171.00	\$216.00
88 R/M/V LH Lever Arm Kit	050439	.[Finish]	-	\$202.00	\$212.00	\$171.00	\$216.00
88-F Rim RH Lever Arm Kit	050440	.[Finish]	-	\$275.00	\$282.00	\$242.00	\$291.00
88-F Rim LH Lever Arm Kit	050441	.[Finish]	-	\$275.00	\$282.00	\$242.00	\$291.00
8827-F/47-F RH Lever Arm Kit	050442	.[Finish]	-	\$275.00	\$282.00	\$242.00	\$291.00
8827-F/47-F LH Lever Arm Kit	050443	.[Finish]	-	\$275.00	\$282.00	\$242.00	\$291.00
8875-F RH Lever Arm Kit	050444	.[Finish]	-	\$275.00	\$282.00	\$242.00	\$291.00
8875-F LH Lever Arm Kit	050445	.[Finish]	-	\$275.00	\$282.00	\$242.00	\$291.00
Axle Security Pin Pkg/50	033022	-	\$59.00	-	-	-	-
Axle Security Pin Pkg/10	090007	-	\$17.00	-	-	-	-
Dog Screw Pkg/2	090004	-	\$23.00	-	-	-	-
Dog Screw Pkg/10	090083	-	\$78.00	-	-	-	-
227 Dog Key 5/32" Pkg/2	090005	-	\$22.00	-	-	-	-

PARTS AND ACCESSORIES

605	606	611	612	613	619	622	625	626	626AM	628	629
US3	US4	US9	US10	US10B	US15	US19	US26	US26D	US26DAM	US28	US32
630	630AM	643e	689	691	693	695	706	710	711	721	728
US32D	US32DAM	-	SP28	SP10	SPBLK	SP313	SP4	313	315	US3A	US4A

LEVER ARMS

Description	Specify		Non-Finished	613, 626	612	606	605, 625, 693
	Part number	Finish					
227 Dog Key 5/32" Pkg/10	090085	-	\$76.00	-	-	-	-
Lever Arm Axles Pkg/2	090006	-	\$34.00	-	-	-	-
Lever Arm Axles Pkg/10	090082	-	\$155.00	-	-	-	-
Wedgetite Screw Pkg/2	090008	-	\$12.00	-	-	-	-
Wedgetite Screws Pkg/30	090081	-	\$57.00	-	-	-	-
Crossbar Tube Attaching Wedge Pkg/2	090020	-	\$14.00	-	-	-	-
Crossbar Tube Attaching Ring Pkg/2	090021	-	\$17.00	-	-	-	-
88 Lever Arm Axle Package	103865	-	\$74.00	-	-	-	-

VERTICAL LATCHES

Description	Specify		Non-Finished	613, 626	612	606	605, 625, 693
	Part number	Finish					
8827 LR Top Latch Kit Less Cover	050460	-	\$219.00	-	-	-	-
8827 LR Bottom Latch Kit Less Cover	050461	-	\$219.00	-	-	-	-
8827-F Top Latch Kit Less Cover	050462	-	\$252.00	-	-	-	-
8827-F Bottom Latch Kit Less Cover	050463	-	\$252.00	-	-	-	-
8827 PL Top Latch Kit Less Cover	050471	-	\$146.00	-	-	-	-
8827 PL Bottom Latch Kit Less Cover	050472	-	\$146.00	-	-	-	-
8827-F/47-F Soffit Latch Kit	114141	-	\$218.00	-	-	-	-
8827 LR Top Latch Kit w/Cover	050466	.[Finish]	-	\$324.00	\$335.00	\$324.00	\$346.00
8827 LR Bottom Latch Kit w/Cover	050467	.[Finish]	-	\$324.00	\$335.00	\$324.00	\$346.00
8827-F Top Latch Kit w/Cover	050468	.[Finish]	-	\$397.00	\$413.00	\$392.00	\$448.00
8827-F Bottom Latch Kit w/Cover	050469	.[Finish]	-	\$397.00	\$413.00	\$392.00	\$448.00
8827 PL Top Latch Kit w/Cover	050473	.[Finish]	-	\$252.00	\$259.00	\$243.00	\$300.00
8827 PL Bottom Latch Kit w/Cover	050479	.[Finish]	-	\$252.00	\$259.00	\$243.00	\$300.00
8827-F Flush Transom Latch Kit w/Cover	050480	.[Finish]	-	\$413.00	\$444.00	\$413.00	\$461.00
8827 Latch Cover Kit	050464	.[Finish]	-	\$90.00	\$99.00	\$90.00	\$115.00
8827-F Top Latch Cover Kit	050465	.[Finish]	-	\$140.00	\$146.00	\$132.00	\$186.00
8827-F Flush Transom Latch Cover Kit	050481	.[Finish]	-	\$194.00	\$204.00	\$194.00	\$218.00
8827 Latch Special Chassis Nut	050277	-	\$14.00	-	-	-	-
8847-F Release Guide Cover w/Screws	050278	.[Finish]	-	\$216.00	\$216.00	\$216.00	\$293.00
8827 LR Top Rod Connector	050279	-	\$17.00	-	-	-	-
8827 LR Bottom Rod Connector	050327	-	\$17.00	-	-	-	-
8827 Chassis Tie Rod	050328	-	\$14.00	-	-	-	-
8827-F Special Chassis Hex Stud	050478	-	\$14.00	-	-	-	-
8827-F Plunger Release Bracket	107765	.[Finish]	-	\$77.00	\$77.00	\$68.00	\$77.00
8827 Latch Case Mounting Package	900501	-	\$12.00	-	-	-	-
8827/47-F Soffit Latch Mounting Package	900502	-	\$12.00	-	-	-	-
8847-F Plunger Release Bracket Package	900576	.[Finish]	-	\$88.00	\$88.00	\$88.00	\$88.00

ELECTRICAL / PARTS ACCESSORIES / PARTS GUARD-X SERIES 94/95 SERIES XP98/XP99 SERIES 98/99 SERIES 88 SERIES 55 SERIES 33A/35A SERIES 22 SERIES

PARTS AND ACCESSORIES

605	606	611	612	613	619	622	625	626	626AM	628	629
US3	US4	US9	US10	US10B	US15	US19	US26	US26D	US26DAM	US28	US32
630	630AM	643e	689	691	693	695	706	710	711	721	728
US32D	US32DAM	-	SP28	SPIO	SPBLK	SP313	SP4	313	315	US3A	US4A

VERTICAL LATCHES

Description	Specify		Non-Finished	613, 626	612	606	605, 625, 693
	Part number	Finish					
8847-F Flush Transom Release Brkt Pkg	900614	.[Finish]	-	\$130.00	\$130.00	\$130.00	\$130.00
8827 Latch Case Cover Screw Package	900850	.[Finish]	-	\$14.00	\$14.00	\$14.00	\$14.00
8827-F Flush Transom Latch Screw Pkg	900852	.[Finish]	-	\$34.00	\$34.00	\$34.00	\$34.00

VERTICAL RODS

Description	Specify		Non-Finished	626	613	612	606	605, 625, 693
	Part number	Finish						
8827 Top Rod Kit	050453	.[Finish]	-	\$115.00	\$115.00	\$134.00	\$115.00	\$148.00
8827-F Top Rod Kit	050454	.[Finish]	-	\$115.00	\$115.00	\$134.00	\$115.00	\$148.00
8827 Bottom Rod Kit	050455	.[Finish]	-	\$115.00	\$115.00	\$134.00	\$115.00	\$148.00
8827-F Bottom Rod Kit	050456	.[Finish]	-	\$115.00	\$115.00	\$134.00	\$115.00	\$148.00
8847-F Top Rod Kit - 6'8"-8' Door	050457	.[Finish]	-	\$421.00	\$421.00	\$421.00	\$421.00	\$421.00
8847-F Bottom Rod Kit	050458	-	\$421.00	-	-	-	-	-
8827 One Piece Top Rod - 8'	050662	.[Finish]	-	\$144.00	\$205.00	\$222.00	\$179.00	\$444.00
8827-F One Piece Top Rod - 8'	050663	.[Finish]	-	\$144.00	\$205.00	\$222.00	\$179.00	\$444.00
8827 12" Extension Rod Kit	051701	.[Finish]	-	\$31.00	\$31.00	\$31.00	\$31.00	\$31.00
8827 24" Extension Rod Kit	051703	.[Finish]	-	\$31.00	\$31.00	\$31.00	\$31.00	\$31.00
8827 36" Extension Rod Kit	050660	.[Finish]	-	\$96.00	\$146.00	\$107.00	\$92.00	\$327.00
8827 48" Extension Rod Kit	050661	.[Finish]	-	\$112.00	\$162.00	\$130.00	\$107.00	\$343.00
8847-F Extension Rod Kit - 8'-10' Door	051705	-	\$31.00	-	-	-	-	-
8847-F Extension Rod Kit - 10'-12' Door	050634	-	\$215.00	-	-	-	-	-
8847-F Extension Rod Kit - 12'-14' Door	050635	-	\$215.00	-	-	-	-	-
8847-F Extension Rod Kit - 14'-16' Door	050636	-	\$215.00	-	-	-	-	-
8827 Extension Rod Coupling	050093	-	\$17.00	-	-	-	-	-
8827 Rod Guide Kit	050482	.[Finish]	-	\$84.00	\$84.00	\$86.00	\$82.00	\$86.00
8827/27-F Bottom Rod Roll Pin Pkg/10	090010	-	\$15.00	-	-	-	-	-
8847/47-F Rod Connector Rivet Pkg/10	090011	-	\$12.00	-	-	-	-	-
8847-F Rod Guide Mtg. Screws Pkg/10	090018	-	\$12.00	-	-	-	-	-
8847-F Bottom Guide Package	100741	-	\$90.00	-	-	-	-	-
8847-F Rod Guide Kit	105140	-	\$25.00	-	-	-	-	-
8827 Rod Guide Mounting Package	900534	.[Finish]	-	\$14.00	\$14.00	\$22.00	\$14.00	\$22.00
8847-F Rod Set Mounting Package	900541	-	\$12.00	-	-	-	-	-
8827 PL Top Rod Connector	967341	-	\$15.00	-	-	-	-	-

98/99 SERIES

605	606	611	612	613	619	622	625	626	626AM	628	629
US3	US4	US9	US10	US10B	US15	US19	US26	US26D	US26DAM	US28	US32
630	630AM	643e	689	691	693	695	706	710	711	721	728
US32D	US32DAM	-	SP28	SP10	SPBLK	SP313	SP4	313	315	US3A	US4A

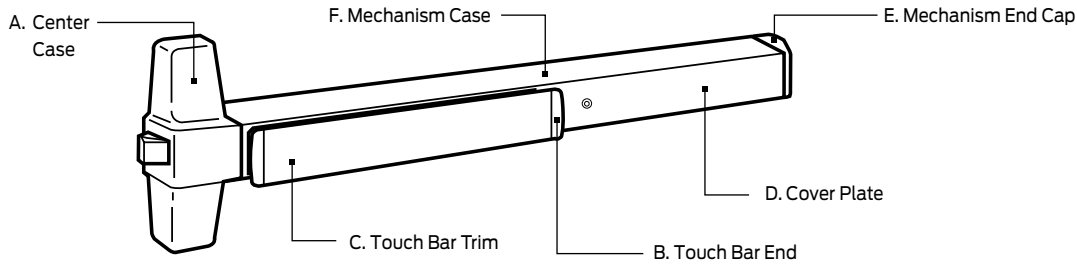

STANDARD FINISHES					
COLOR	US NUMBER	BHMA NUMBER	A, B, E	C - TOUCH BAR TRIM FINISHES	D, F
Bright Brass	US3	605	Bright Brass	Bright Brass, 605 (US3)	Buffed Anodized
Satin Brass	US4	606	Satin Brass	Satin Brass, 606 (US4)	Anodized
Satin Bronze	US10	612	Plated/Anodized	Satin Bronze, 725 (US10)	Anodized
Satin Bronze, Oil-Rubbed	US10B	613	Oil-Rubbed	Oil-Rubbed, 613 (US10B)	Powder Coat
Satin Nickel	US15	619	Plated, Clear Powder Coat	Satin Stainless Steel, 630 (US32D)	Anodized
Polished Chrome	US26	625	Plated	Bright Stainless Steel, 629 (US32)	Buffed Anodized
Satin Chrome	US26D	626	Plated	Satin Stainless Steel, 630 (US32D)	Anodized
Anodized Aluminum	US28	628	Powder Coat	Satin Stainless Steel, 630 (US32D)	Anodized
Satin Stainless Steel	US32D	630	Stainless Steel	Satin Stainless Steel, 630 (US32D)	Anodized
Duranodic Dark Bronze	313	710	Powder Coat	Powder Coat, 710 (313)	Powder Coat
Black	315	711	Powder Coat	Powder Coat, 711 (315)	Powder Coat
Aged Bronze, 643e	--	--	(A) Aged Bronze, No Relief (B, E) Relieved Aged Bronze	Relieved Aged Bronze	Aged Bronze, No Relief

SPECIAL FINISHES					
COLOR	US NUMBER	BHMA NUMBER	A, B, E	C - TOUCH BAR TRIM FINISHES	D, F
Bright Bronze	US9	611	Plated	Bright Bronze US9, 611	Buffed Anodized
Satin Chrome, Antimicrobial	US26D-AM	626-AM	AM Clear over Chrome	AM Clear over Satin Stainless Steel US32D, 630	AM Clear over Anodized
Satin Stainless Steel, Antimicrobial	US32D-AM	630-AM	AM Clear over Stainless Steel	AM Clear over Satin Stainless Steel US32D, 630	AM Clear over Anodized
Powder Coat	RAL # *	--	Powder Coat	Powder Coat	Powder Coat

* See Finish page for optional RAL color information.

FINISH NOTES: 619 and 630 finishes available on Series 98 only. Devices ordered in 628 and 630 will be supplied with Trims in 626.

98/99 SERIES SEX BOLT QUANTITIES				
APPLICATION	SEX BOLT 325 (SUPPLIED)	425 SEX BOLT (SUPPLIED)	425 SEX BOLT (OPTIONAL)	825 SEX BOLT (SUPPLIED)
DT, EO, NL, TP, K or L Device with trim			2	
99 NLOP Device with 110MD/WD			6	
9927 NLOP Device with 110MD/WD			6	
99 EO Device (exit device only)			6	
9927 EO Device (exit device only)			6	
9947 EO Device (exit device only)			6	
99-F Wood Door with trim				2
Windstorm Device	12	6		

22 SERIES
 33A/35A SERIES
 55 SERIES
 88 SERIES
 98/99 SERIES
 XP98/XP99 SERIES
 94/95 SERIES
 GUARD-X SERIES
 ACCESSORIES / PARTS
 ELECTRICAL / PARTS

98/99 SERIES

605	606	611	612	613	619	622	625	626	626AM	628	629
US3	US4	US9	US10	US10B	US15	US19	US26	US26D	US26DAM	US28	US32
630	630AM	643e	689	691	693	695	706	710	711	721	728
US32D	US32DAM	-	SP28	SP10	SPBLK	SP313	SP4	313	315	US3A	US4A

TYPE OF DEVICE: 98 (SMOOTH) 99 (GROOVED)

98 or 99 Rim	X98 or X99 Rim	9827 or 9927 Surface Vertical Rod	9857 or 9957 Surface Three Point Latch
9875 or 9975 Mortise Lock	9847 or 9947 / 9848 or 9948 Concealed Vertical Rod	9847 WDC or 9947 WDC Wood Door Concealed Vertical Rod	9849 or 9949 Concealed Vertical Cable
9850 WDC or 9950 WDC Wood Door Concealed Vertical Cable	9852 or 9952 Rim with Remote Trim Input		

FUNCTION

DT: Dummy Trim	EO: Exit Only	HL: Hospital Latch	K: Knob
KBE: Knob Blank Escutcheon	KDT: Knob Dummy	KNL: Knob Night Latch	L: Lever, O6 Standard
LBE: Lever-Blank Escutcheon	LDT: Lever, Dummy Trim	LNL: Lever-Night Latch	NL: Night Latch, Key Retracts
NLOP: Night Latch, Opt. Pull	TL: Turn Lever	TLBE: Turn Lever, Blank Escutcheon	TLOP: Turn Lever, Opt. Pull
TP: Thumbpiece	TPBE: Thumbpiece - Blank Escutcheon		

RATING

None: Panic Exit Device	- F: Fire Exit Device
-------------------------	-----------------------

DOUBLE CYLINDER

-2: Double Cylinder	-2S1: Cylinder Dogging with Security Indicator
---------------------	--

DEVICE FINISH

605: Bright Brass (US3)	606: Satin Brass (US4)	612: Satin Bronze (US10)	613: Satin Bronze-Oil Rubbed (US10B)
625: Bright Chrome (US26)	626: Satin Chrome (US26D)	626AM: Antimicrobial (US26D-AM)	628: Anodized Aluminum (US28)
643e: Aged Bronze	710: Duranodic Dark Bronze (313)	711: Black (315)	

Note: 619: Satin Nickel (US15) 98 Series only.

DEVICE LENGTH (FEET AND INCHES)

2': 2' Device for 2' Door - Vertical Device only	3': 3' Device for 2' 4" - 3' Door	4': 4' Device for 2' 10" - 4' Door
--	-----------------------------------	------------------------------------

DEVICE HANDING

RHR (Right Hand Reverse)	LHR (Left Hand Reverse)
--------------------------	-------------------------

TRIM / CONTROL OPTIONS

LC Less Control	LT: Less Trim	110MD / 110WD: Standard on NL-OP	374T: Thumbturn Control - SV
376T: Thumbturn Control - CV	376T WDC: 376T for Wood Door	392-7: Optional Pull Dummy Trim	696 / 696WDF: Optional Lever Trim
697 / 697WDF: Optional Lever Trim	VR910: Vandal Resistant	990: Standard Rim	996: Standard. Lever Trim
RX996: Request to Exit 996	M996: Motorized 996	QM996: Quiet Mechanical Trim	

CONTROL LEVER STYLES 06 LEVER STANDARD

Standard levers:	01	02	03	05	06	07	12	16	17	18
	ACC: Accent 	AST: Asti 	MER: Merano 	LAT: Latitude	LON: Longitude					
Knurled levers:	03K	06K	M81K							

 Indicates products that have EPD documentation available and meet LEED v4.

98/99 SERIES

605	606	611	612	613	619	622	625	626	626AM	628	629
US3	US4	US9	US10	US10B	US15	US19	US26	US26D	US26DAM	US28	US32
630	630AM	643e	689	691	693	695	706	710	711	721	728
US32D	US32DAM	-	SP28	SP10	SPBLK	SP313	SP4	313	315	US3A	US4A

CONTROL LEVER STYLES 06 LEVER STANDARD

M Collection lever:	M51	M52	M53	M54	M55	M56	M61	M63
	M81	M82	M83	M84	M85	ME1	ME2	ME3
Stainless steel levers:	03SS	06SS	17SS	LATSS	LONSS	M57	M62	

TRIM / CONTROL / MORTISE FINISH

605: Bright Brass (US3)	606: Satin Brass (US4)	612: Satin Bronze (US10)	613: Satin Bronze-Oil Rubbed (US10B)
625: Bright Chrome (US26)	626: Satin Chrome (US26D)	693: Painted Black (SPBLK)	710: Duranodic Dark Bronze (313)
619: Satin Nickel (US15)	622: Matte Black (US19)	626AM: Antimicrobial (US26D-AM)	629: Bright Stainless (US32)
630: Satin Stainless (US32D)			

MORTISE LOCK

LL: Less Lock	7500: Standard Mortise	SS7500: Signal Switch	7500-2: Double Cylinder
E7500: Electric Unlocking			

RODS FOR SURFACE / CONCEALED VERTICAL DEVICES ONLY

OPR: One Piece Top Rod	LBL: Less Bottom Cable	LBLAFL: LBL with Auxiliary Fire Pin	LBR: Less Bottom Rod
LBRAFL: LBR with Auxiliary Fire Pin			

DOGGING OPTIONS

CD: Cylinder Dogging, Panic Only	CDSI: Cylinder Dogging with Indicator	CI: Cylinder Dogging Indicator	DI: Dogging Indicator
HD: Hex Dogging	HDSI: Hex Dogging with Indicator	LD: Less Dogging	SD: Special Dogging

SWITCH OPTIONS

LX: Latchbolt Monitoring	LXLC: LBM Low Current	LXR: LBM Request to Exit	LXRXC: LBM Request to Exit Low Current
RX: Request to Exit	RX2: Request to Exit Double Switch	RXLC: Request to Exit Low Current	SS: Signal Switch, Rim or Mortise
WPRX: Waterproof Request to Exit			

LATCH RETRACTION OPTIONS

E: Electric Mortise Lock	EL: Electric Latch Retraction	HD-EL: Electric latch retraction (panic only)	HD-QEL: Quiet electric latch retraction with hex dogging (panic only)
HD-QELX: Quiet electric latch retraction with hex dogging (panic only) for AX devices	QEL: Quiet Electric Latch Retraction	QELA: Quiet Electric Latch Retraction	QELX: Quiet electric latch retraction for AX devices
PN: Pneumatic Latch Retraction			

QUIET MECHANICAL - CONTROLS MOTION TO REDUCE OPERATIONAL NOISE

QM98/99 Rim	QM98/9927 Surface Vertical Rod	QM996 Trim	
-------------	--------------------------------	------------	--

CX DELAYED EGRESS

CX: Chexit - Controlled Exit	CXRCM: Remote Chexit Module		
------------------------------	-----------------------------	--	--

98/99 SERIES

605	606	611	612	613	619	622	625	626	626AM	628	629
US3	US4	US9	US10	US10B	US15	US19	US26	US26D	US26DAM	US28	US32
630	630AM	643e	689	691	693	695	706	710	711	721	728
US32D	US32DAM	-	SP28	SP10	SPBLK	SP313	SP4	313	315	US3A	US4A

ELECTRICAL LOCKING

ES: Pullman Latch for Electric Strike FS: Fail Safe FSE: Fail Secure

STORM RATING

HH: Hurricane device HHCX: Hurricane CX HHCXR: Hurricane CX-RCM WS: Windstorm

ACCESSIBLE DEVICE

AX: Accessible device compliant with the California Building Code (Section 11B-309.4) requirement for 5 lb. maximum operational force.

STRIKE SERIES

LS: Less Strike	LTS: Less Top Strike	1410: Optional Rim	1606: Optional Rim
1609: Optional Rim	249: Standard CVC	260U: Optional SV Flush Transom	260UF: Option SV Fire Flush Transom
264: Optional Rim or SV	283: Optional CV - Wood Frame	299: Optional Rim	299F: Standard SV Fire
338: Standard CV	499F: Standard SV Fire LBR	575 / 575-2: Standard Mortise	576A: Mortise, pairs 1-3/4 Dr
576B: Mortise, pairs 2-1/4 Dr			

BOTTOM STRIKE SERIES

LBS: Less Bottom Strike	248L4: Surface	304L: Mortise	349: Standard CVC
385A: Adjustable Mortise			

STRIKE FINISH

605: Bright Brass (US3)	606: Satin Brass (US4)	612: Satin Bronze (US10)	613: Satin Bronze-Oil Rubbed (US10B)
622: Matte Black (US19)	625: Bright Chrome(US26)	626: Satin Chrome (US26D)	629: Bright Stainless (US32)
630: Satin Stainless (US32D)	691: Painted Light Bronze (SP10)	695: Painted Dark Bronze (SP313)	MD: e-Moly

TOUCH BAR TRIM OPTIONS

BR: Braille	EMB: Embossed "Push"	KN: Knurled	RSS: Emergency Exit (630 only)
SG: Safety Glow			

DRAINAGE / WEEP HOLES

WH: Drainage/Weep Holes in Mechanism Case (3' device will have 5 holes, 6" spacing; 4' device will have 7 holes, 6" spacing)

CX DELAYED EGRESS RELEASE DELAY

0SEC: 0 second delay	15SEC: 15 second delay	INFDEL: Infinite delay	30SEC: 30 second delay
M15SEC: 15 second mute delay	BOCA15SEC: BOCA 15 second delay	LRG (Less Rod Guards)	RGO (Rod Guards Only)

MISC DEVICE OPTIONS

CE: CE Label	10WDA: WDA cover plate	ALK: Standard Alarm Kit	RAT REL: Ratchet Release Assy
LCP: Less cover plate	PL: Include Pullman Latch	CYL: Include Cylinder	SNB: Include # of Sex Bolts

98/99 SERIES

605	606	611	612	613	619	622	625	626	626AM	628	629
US3	US4	US9	US10	US10B	US15	US19	US26	US26D	US26DAM	US28	US32
630	630AM	643e	689	691	693	695	706	710	711	721	728
US32D	US32DAM	-	SP28	SP10	SPBLK	SP313	SP4	313	315	US3A	US4A

CONNECTOR

CON: Connectors

SLM BLOCKING

SLM: SLM Blocking

SECURITY SCREWS

SEC: Include Security Screws

GBK/SHIM KIT/RISES

GBK: Include GBK

DOOR MATERIAL

ALD: Aluminum door	CP: Composite door	HMD: Hollow metal	WD: Wood door
INS2: Insulclad - 1/2"	INS4: Insulclad - 1/4"	SC: Steelcraft (HH Device Only)	

DOOR THICKNESS

DT1-3/4: 1-3/4" Standard	DT2: 2" thickness	DT2-1/4: 2-1/4" thickness
--------------------------	-------------------	---------------------------

DOOR MODE/APPLICATION

DE: Pair Double egress doors	PR: Pair of doors	SGL: Single door
------------------------------	-------------------	------------------

APPLICATION NOTE FOR 2' DEVICE

Available on Surface and Concealed Vertical (panic and fire).

When vertical rod devices are used on both doors of a pair, operation of the inactive door (smaller door) will not disengage the active door, creating a potential safety issue for those using the inactive door during an emergency. In addition, standard hex or cylinder dogging is not available. If dogging is required, special center case dogging is available for 98/9927/47 devices. Prefix device with "SD".

For pairs of doors using one 2' door Von Duprin recommends the following hardware combinations listed below for optimum safety in an emergency.

1. Surface or Concealed Vertical device on the 2' door (inactive) and a mortise device on the larger door (active). This combination is used primarily on Hollow Metal door applications only.
2. Automatic Flush Bolt on the 2' door (inactive) and a Surface or Concealed Vertical device on the larger door (active).

Note: The 2' door width is not available with any electrical, Chexit, hurricane or windstorm options.

98/99 SERIES

605	606	611	612	613	619	622	625	626	626AM	628	629
US3	US4	US9	US10	US10B	US15	US19	US26	US26D	US26DAM	US28	US32
630	630AM	643e	689	691	693	695	706	710	711	721	728
US32D	US32DAM	-	SP28	SPI0	SPBLK	SP313	SP4	313	315	US3A	US4A

Rim devices

ACN							PRICE BASED ON FINISH						Default trim, included			
Device type	Function	Fire	Finish	Device size	Handing	Lever design	626	628	630	710	612	606 ²		605 ² 619 ¹ 625 643E	711	613 ²
EXIT HARDWARE							3¹ DEVICE PRICING SHOWN. 4¹ ADD \$19.00 LIST									
[98/99]	EO	.	[]	[]	.		\$1,486	\$1,339	\$1,528	\$1,422	\$1,528	\$1,581	\$1,763	\$2,172	\$1,772	N/A
[98/99]	DT	.	[]	[]	.		\$1,755	\$1,608	\$1,797	\$1,704	\$1,810	\$1,798	\$2,057	\$2,454	\$2,054	990DT
[98/99]	NL	.	[]	[]	[]		\$1,771	\$1,624	\$1,813	\$1,720	\$1,826	\$1,814	\$2,073	\$2,470	\$2,070	990NL-R/V
[98/99]	NL-OP	.	[]	[]	.		\$1,626	\$1,479	\$1,668	\$1,562	\$1,668	\$1,711	\$1,903	\$2,312	\$1,912	110MD/WD
[98/99]	TP	.	[]	[]	.		\$1,873	\$1,726	\$1,915	\$1,820	\$1,915	\$1,903	\$2,179	\$2,570	\$2,170	990TP-R/V
[98/99]	TP-BE	.	[]	[]	.		\$1,873	\$1,726	\$1,915	\$1,820	\$1,915	\$1,903	\$2,179	\$2,570	\$2,170	990TP-BE-R/V
[98/99]	K	.	[]	[]	.		\$1,962	\$1,815	\$2,004	\$1,898	\$2,068	\$1,981	\$2,338	\$2,648	\$2,248	996K-R/V
[98/99]	K-BE	.	[]	[]	.		\$1,962	\$1,815	\$2,004	\$1,898	\$2,068	\$1,981	\$2,338	\$2,648	\$2,248	996K-BE-R/V
[98/99]	K-DT	.	[]	[]	.		\$1,952	\$1,805	\$1,994	\$1,888	\$2,058	\$1,971	\$2,328	\$2,638	\$2,238	996K-DT-R/V
[98/99]	K-NL	.	[]	[]	.		\$1,952	\$1,805	\$1,994	\$1,888	\$2,058	\$1,971	\$2,328	\$2,638	\$2,238	996K-NL-R/V
[98/99]	L	.	[]	[]	[]	[]	\$2,105	\$1,958	\$2,147	\$2,041	\$2,202	\$2,169	\$2,464	\$2,791	\$2,413	996L-R/V
[98/99]	L-BE	.	[]	[]	[]	[]	\$2,105	\$1,958	\$2,147	\$2,041	\$2,202	\$2,169	\$2,464	\$2,791	\$2,413	996L-BE-R/V
[98/99]	L-DT	.	[]	[]	[]	[]	\$1,979	\$1,832	\$2,021	\$1,915	\$2,076	\$2,043	\$2,338	\$2,665	\$2,287	996L-DT-R/V
[98/99]	L-NL	.	[]	[]	[]	[]	\$1,979	\$1,832	\$2,021	\$1,915	\$2,076	\$2,043	\$2,338	\$2,665	\$2,287	996L-NL-R/V
FIRE EXIT HARDWARE							3¹ DEVICE PRICING SHOWN. 4¹ ADD \$19.00 LIST									
[98/99]	EO	.	F	[]	[]		\$1,701	\$1,554	\$1,743	\$1,637	\$1,743	\$1,796	\$1,978	\$2,387	\$1,987	N/A
[98/99]	DT	.	F	[]	[]		\$1,970	\$1,823	\$2,012	\$1,919	\$2,025	\$2,013	\$2,272	\$2,669	\$2,269	990DT
[98/99]	NL	.	F	[]	[]	[]	\$1,986	\$1,839	\$2,028	\$1,935	\$2,041	\$2,029	\$2,288	\$2,685	\$2,285	990NL-R/V
[98/99]	NL-OP	.	F	[]	[]		\$1,841	\$1,694	\$1,883	\$1,777	\$1,883	\$1,926	\$2,118	\$2,527	\$2,127	110MD/WD
[98/99]	TP	.	F	[]	[]		\$2,088	\$1,941	\$2,130	\$2,035	\$2,130	\$2,118	\$2,394	\$2,785	\$2,385	990TP-R/V
[98/99]	TP-BE	.	F	[]	[]		\$2,088	\$1,941	\$2,130	\$2,035	\$2,130	\$2,118	\$2,394	\$2,785	\$2,385	990TP-BE-R/V
[98/99]	K	.	F	[]	[]		\$2,177	\$2,030	\$2,219	\$2,113	\$2,283	\$2,196	\$2,553	\$2,863	\$2,463	996K-R/V
[98/99]	K-BE	.	F	[]	[]		\$2,177	\$2,030	\$2,219	\$2,113	\$2,283	\$2,196	\$2,553	\$2,863	\$2,463	996K-BE-R/V
[98/99]	K-NL	.	F	[]	[]		\$2,167	\$2,020	\$2,209	\$2,103	\$2,273	\$2,186	\$2,543	\$2,853	\$2,453	996K-NL-R/V
[98/99]	L	.	F	[]	[]	[]	\$2,320	\$2,173	\$2,362	\$2,256	\$2,417	\$2,384	\$2,679	\$3,006	\$2,628	996L-R/V
[98/99]	L-BE	.	F	[]	[]	[]	\$2,320	\$2,173	\$2,362	\$2,256	\$2,417	\$2,384	\$2,679	\$3,006	\$2,628	996L-BE-R/V
[98/99]	L-NL	.	F	[]	[]	[]	\$2,194	\$2,047	\$2,236	\$2,130	\$2,291	\$2,258	\$2,553	\$2,880	\$2,502	996L-NL-R/V

² Consult factory for lead time.

¹ 630 and 619 finishes available only on 98 Series.

² 613 finish has 710 finish device with 613 parts.

DEFAULT ATTRIBUTES

Pricing includes default options shown below. Additional options and configurations available.

Cylinders:	Sex bolts	Door thickness	Center line
Not included	Not included	1-3/4"	39-13/16"

Strike(s):

Exit hardware:

- Includes 299 strike

Fire exit hardware:

- Single door applications: Includes 299F strike
- Double door applications: 499F strike will be supplied at an additional \$112 list add

98/99 SERIES

605	606	611	612	613	619	622	625	626	626AM	628	629
US3	US4	US9	US10	US10B	US15	US19	US26	US26D	US26DAM	US28	US32
630	630AM	643e	689	691	693	695	706	710	711	721	728
US32D	US32DAM	-	SP28	SPIO	SPBLK	SP313	SP4	313	315	US3A	US4A

Surface vertical rod devices (27)

ACN							PRICE BASED ON FINISH							Default trim, included		
Device type	Function	Fire	Finish	Device size	Handing	Lever design	626	628	630	710	612	606 ²	605 ² 619 ¹ 625 643E		711	613 ²
EXIT HARDWARE							3' DEVICE PRICING SHOWN. 2' ADD \$78.00 LIST, 4' ADD \$19.00 LIST									
[98/99]27 . EO		[]	[]				\$2,165	\$1,929	\$2,312	\$2,111	\$2,248	\$2,337	\$2,497	\$2,848	\$2,664	N/A
[98/99]27 . DT		[]	[]				\$2,434	\$2,198	\$2,581	\$2,393	\$2,530	\$2,554	\$2,791	\$3,130	\$2,946	990DT
[98/99]27 . NL		[]	[]	[]	[]		\$2,450	\$2,214	\$2,597	\$2,409	\$2,546	\$2,570	\$2,807	\$3,146	\$2,962	990NL-R/V
[98/99]27 . NL-OP		[]	[]	[]	[]		\$2,305	\$2,069	\$2,452	\$2,251	\$2,388	\$2,467	\$2,637	\$2,988	\$2,804	110MD/WD
[98/99]27 . TP		[]	[]	[]	[]		\$2,552	\$2,316	\$2,699	\$2,509	\$2,635	\$2,659	\$2,913	\$3,246	\$3,062	990TP-R/V
[98/99]27 . TP-BE		[]	[]	[]	[]		\$2,552	\$2,316	\$2,699	\$2,509	\$2,635	\$2,659	\$2,913	\$3,246	\$3,062	990TP-BE-R/V
[98/99]27 . K		[]	[]	[]	[]		\$2,641	\$2,405	\$2,788	\$2,587	\$2,788	\$2,737	\$3,072	\$3,324	\$3,140	996K-R/V
[98/99]27 . K-BE		[]	[]	[]	[]		\$2,641	\$2,405	\$2,788	\$2,587	\$2,788	\$2,737	\$3,072	\$3,324	\$3,140	996K-BE-R/V
[98/99]27 . K-DT		[]	[]	[]	[]		\$2,631	\$2,395	\$2,778	\$2,577	\$2,778	\$2,727	\$3,062	\$3,314	\$3,130	996K-DT-R/V
[98/99]27 . K-NL		[]	[]	[]	[]		\$2,631	\$2,395	\$2,778	\$2,577	\$2,778	\$2,727	\$3,062	\$3,314	\$3,130	996K-NL-R/V
[98/99]27 . L		[]	[]	[]	[]	[]	\$2,784	\$2,548	\$2,931	\$2,730	\$2,922	\$2,925	\$3,198	\$3,467	\$3,305	996L-R/V
[98/99]27 . L-BE		[]	[]	[]	[]	[]	\$2,784	\$2,548	\$2,931	\$2,730	\$2,922	\$2,925	\$3,198	\$3,467	\$3,305	996L-BE-R/V
[98/99]27 . L-DT		[]	[]	[]	[]	[]	\$2,658	\$2,422	\$2,805	\$2,604	\$2,796	\$2,799	\$3,072	\$3,341	\$3,179	996L-DT-R/V
[98/99]27 . L-NL		[]	[]	[]	[]	[]	\$2,658	\$2,422	\$2,805	\$2,604	\$2,796	\$2,799	\$3,072	\$3,341	\$3,179	996L-NL-R/V
[98/99]27 . TL		[]	[]	[]	[]		\$3,216	\$2,980	\$3,363	\$3,175	\$3,372	\$3,228	\$3,633	\$3,912	\$3,728	990DT/374T ³
[98/99]27 . TL-BE		[]	[]	[]	[]		\$3,173	\$2,937	\$3,320	\$3,132	\$3,329	\$3,185	\$3,590	\$3,869	\$3,685	990DT/374T-BE ³
FIRE EXIT HARDWARE							3' DEVICE PRICING SHOWN. 2' ADD \$78.00 LIST, 4' ADD \$19.00 LIST									
[98/99]27 . EO	F	[]	[]	[]	[]		\$2,481	\$2,245	\$2,628	\$2,427	\$2,564	\$2,653	\$2,813	\$3,164	\$2,980	N/A
[98/99]27 . DT	F	[]	[]	[]	[]		\$2,750	\$2,514	\$2,897	\$2,709	\$2,846	\$2,870	\$3,107	\$3,446	\$3,262	990DT
[98/99]27 . NL	F	[]	[]	[]	[]		\$2,766	\$2,530	\$2,913	\$2,725	\$2,862	\$2,886	\$3,123	\$3,462	\$3,278	990NL-R/V
[98/99]27 . NL-OP	F	[]	[]	[]	[]		\$2,621	\$2,385	\$2,768	\$2,567	\$2,704	\$2,783	\$2,953	\$3,304	\$3,120	110MD/WD
[98/99]27 . TP	F	[]	[]	[]	[]		\$2,868	\$2,632	\$3,015	\$2,825	\$2,951	\$2,975	\$3,229	\$3,562	\$3,378	990TP-R/V
[98/99]27 . TP-BE	F	[]	[]	[]	[]		\$2,868	\$2,632	\$3,015	\$2,825	\$2,951	\$2,975	\$3,229	\$3,562	\$3,378	990TP-BE-R/V
[98/99]27 . K	F	[]	[]	[]	[]		\$2,957	\$2,721	\$3,104	\$2,903	\$3,104	\$3,053	\$3,388	\$3,640	\$3,456	996K-R/V
[98/99]27 . K-BE	F	[]	[]	[]	[]		\$2,957	\$2,721	\$3,104	\$2,903	\$3,104	\$3,053	\$3,388	\$3,640	\$3,456	996K-BE-R/V
[98/99]27 . K-NL	F	[]	[]	[]	[]		\$2,947	\$2,711	\$3,094	\$2,893	\$3,094	\$3,043	\$3,378	\$3,630	\$3,446	996K-NL-R/V
[98/99]27 . L	F	[]	[]	[]	[]	[]	\$3,100	\$2,864	\$3,247	\$3,046	\$3,238	\$3,241	\$3,514	\$3,783	\$3,621	996L-R/V
[98/99]27 . L-BE	F	[]	[]	[]	[]	[]	\$3,100	\$2,864	\$3,247	\$3,046	\$3,238	\$3,241	\$3,514	\$3,783	\$3,621	996L-BE-R/V
[98/99]27 . L-NL	F	[]	[]	[]	[]	[]	\$2,974	\$2,738	\$3,121	\$2,920	\$3,112	\$3,115	\$3,388	\$3,657	\$3,495	996L-NL-R/V
[98/99]27 . TL	F	[]	[]	[]	[]		\$3,532	\$3,296	\$3,679	\$3,491	\$3,688	\$3,544	\$3,949	\$4,228	\$4,044	990DT/374T ³
[98/99]27 . TL-BE	F	[]	[]	[]	[]		\$3,489	\$3,253	\$3,636	\$3,448	\$3,645	\$3,501	\$3,906	\$4,185	\$4,001	990DT/374T-BE ³

² Consult factory for lead time.

¹ 630 and 619 finishes available only on 98 Series.

² 613 finish has 710 finish device with 613 parts.

³ Wood doors - 10WDA cover plate is required for the 370 series controls and will be supplied at an additional, \$56 list add.

DEFAULT ATTRIBUTES

Pricing includes default options shown below. Additional options and configurations available.

Cylinders:	Sex bolts	Door thickness	Center line
Not included	Not included	1-3/4"	39-13/16"

Strike(s): Exit hardware:

- Includes 299, 248L-4, 304L strikes and sex bolts for latches

Fire exit hardware:

- Includes 299F, 304L strikes and sex bolts for latches

98/99 SERIES

605	606	611	612	613	619	622	625	626	626AM	628	629
US3	US4	US9	US10	US10B	US15	US19	US26	US26D	US26DAM	US28	US32
630	630AM	643e	689	691	693	695	706	710	711	721	728
US32D	US32DAM	-	SP28	SPI0	SPBLK	SP313	SP4	313	315	US3A	US4A

Concealed vertical rod devices (47)

ACN							PRICE BASED ON FINISH						Default trim, included			
Device type	Function	Fire	Finish	Device size	Handing	Lever design	626	628	630	710	612	606 ²		605 ² 619 ¹ 625 643E	711	613 ²
EXIT HARDWARE							3' DEVICE PRICING SHOWN. 2' ADD \$78.00 LIST, 4' ADD \$19.00 LIST									
[98/99]47	EO	.	[]	.	[]	.	\$2,263	\$2,019	\$2,325	\$2,201	\$2,293	\$2,381	\$2,527	\$2,938	\$2,712	N/A
[98/99]47	DT	.	[]	.	[]	.	\$2,532	\$2,288	\$2,594	\$2,483	\$2,575	\$2,598	\$2,821	\$3,220	\$2,994	990DT
[98/99]47	NL	.	[]	.	[]	.	\$2,548	\$2,304	\$2,610	\$2,499	\$2,591	\$2,614	\$2,837	\$3,236	\$3,010	990NL-R/V
[98/99]47	NL-OP	.	[]	.	[]	.	\$2,403	\$2,159	\$2,465	\$2,341	\$2,433	\$2,511	\$2,667	\$3,078	\$2,852	110MD/WD
[98/99]47	TP	.	[]	.	[]	.	\$2,650	\$2,406	\$2,712	\$2,599	\$2,680	\$2,703	\$2,943	\$3,336	\$3,110	990TP-R/V
[98/99]47	TP-BE	.	[]	.	[]	.	\$2,650	\$2,406	\$2,712	\$2,599	\$2,680	\$2,703	\$2,943	\$3,336	\$3,110	990TP-BE-R/V
[98/99]47	K	.	[]	.	[]	.	\$2,739	\$2,495	\$2,801	\$2,677	\$2,833	\$2,781	\$3,102	\$3,414	\$3,188	996K-R/V
[98/99]47	K-BE	.	[]	.	[]	.	\$2,739	\$2,495	\$2,801	\$2,677	\$2,833	\$2,781	\$3,102	\$3,414	\$3,188	996K-BE-R/V
[98/99]47	K-DT	.	[]	.	[]	.	\$2,729	\$2,485	\$2,791	\$2,667	\$2,823	\$2,771	\$3,092	\$3,404	\$3,178	996K-DT-R/V
[98/99]47	K-NL	.	[]	.	[]	.	\$2,729	\$2,485	\$2,791	\$2,667	\$2,823	\$2,771	\$3,092	\$3,404	\$3,178	996K-NL-R/V
[98/99]47	L	.	[]	.	[]	.	\$2,882	\$2,638	\$2,944	\$2,820	\$2,967	\$2,969	\$3,228	\$3,557	\$3,353	996L-R/V
[98/99]47	L-BE	.	[]	.	[]	.	\$2,882	\$2,638	\$2,944	\$2,820	\$2,967	\$2,969	\$3,228	\$3,557	\$3,353	996L-BE-R/V
[98/99]47	L-DT	.	[]	.	[]	.	\$2,756	\$2,512	\$2,818	\$2,694	\$2,841	\$2,843	\$3,102	\$3,431	\$3,227	996L-DT-R/V
[98/99]47	L-NL	.	[]	.	[]	.	\$2,756	\$2,512	\$2,818	\$2,694	\$2,841	\$2,843	\$3,102	\$3,431	\$3,227	996L-NL-R/V
[98/99]47	TL	.	[]	.	[]	.	\$3,314	\$3,070	\$3,376	\$3,265	\$3,417	\$3,272	\$3,663	\$4,002	\$3,776	990DT/374T ³
[98/99]47	TL-BE	.	[]	.	[]	.	\$3,271	\$3,027	\$3,333	\$3,222	\$3,374	\$3,229	\$3,620	\$3,959	\$3,733	990DT/374T-BE ³
FIRE EXIT HARDWARE							3' DEVICE PRICING SHOWN. 2' ADD \$78.00 LIST, 4' ADD \$19.00 LIST									
[98/99]47	EO	.	F	.	[]	.	\$2,615	\$2,371	\$2,677	\$2,553	\$2,645	\$2,733	\$2,879	\$3,290	\$3,064	N/A
[98/99]47	DT	.	F	.	[]	.	\$2,884	\$2,640	\$2,946	\$2,835	\$2,927	\$2,950	\$3,173	\$3,572	\$3,346	990DT
[98/99]47	NL	.	F	.	[]	.	\$2,900	\$2,656	\$2,962	\$2,851	\$2,943	\$2,966	\$3,189	\$3,588	\$3,362	990NL-R/V
[98/99]47	NL-OP	.	F	.	[]	.	\$2,755	\$2,511	\$2,817	\$2,693	\$2,785	\$2,863	\$3,019	\$3,430	\$3,204	110MD/WD
[98/99]47	TP	.	F	.	[]	.	\$3,002	\$2,758	\$3,064	\$2,951	\$3,032	\$3,055	\$3,295	\$3,688	\$3,462	990TP-R/V
[98/99]47	TP-BE	.	F	.	[]	.	\$3,002	\$2,758	\$3,064	\$2,951	\$3,032	\$3,055	\$3,295	\$3,688	\$3,462	990TP-BE-R/V
[98/99]47	K	.	F	.	[]	.	\$3,091	\$2,847	\$3,153	\$3,029	\$3,185	\$3,133	\$3,454	\$3,766	\$3,540	996K-R/V
[98/99]47	K-BE	.	F	.	[]	.	\$3,091	\$2,847	\$3,153	\$3,029	\$3,185	\$3,133	\$3,454	\$3,766	\$3,540	996K-BE-R/V
[98/99]47	K-NL	.	F	.	[]	.	\$3,081	\$2,837	\$3,143	\$3,019	\$3,175	\$3,123	\$3,444	\$3,756	\$3,530	996K-NL-R/V
[98/99]47	L	.	F	.	[]	.	\$3,234	\$2,990	\$3,296	\$3,172	\$3,319	\$3,321	\$3,580	\$3,909	\$3,705	996L-R/V
[98/99]47	L-BE	.	F	.	[]	.	\$3,234	\$2,990	\$3,296	\$3,172	\$3,319	\$3,321	\$3,580	\$3,909	\$3,705	996L-BE-R/V
[98/99]47	L-NL	.	F	.	[]	.	\$3,108	\$2,864	\$3,170	\$3,046	\$3,193	\$3,195	\$3,454	\$3,783	\$3,579	996L-NL-R/V
[98/99]47	TL	.	F	.	[]	.	\$3,666	\$3,422	\$3,728	\$3,617	\$3,769	\$3,624	\$4,015	\$4,354	\$4,128	990DT/374T ³
[98/99]47	TL-BE	.	F	.	[]	.	\$3,623	\$3,379	\$3,685	\$3,574	\$3,726	\$3,581	\$3,972	\$4,311	\$4,085	990DT/374T-BE ³

² Consult factory for lead time.

¹ 630 and 619 finishes available only on 98 Series.

² 613 finish has 710 finish device with 613 parts.

³ Wood doors - 10WDA cover plate is required for the 370 series controls and will be supplied at an additional, \$56 list add.

DEFAULT ATTRIBUTES

Pricing includes default options shown below. Additional options and configurations available.

Cylinders:	Sex bolts	Door thickness	Center line
Not included	Not included	1-3/4"	39-13/16"

Strike(s): Exit hardware:

- Includes 338 and 385A strikes

Fire exit hardware:

- Includes 338 and 385A strikes

98/99 SERIES

605	606	611	612	613	619	622	625	626	626AM	628	629
US3	US4	US9	US10	US10B	US15	US19	US26	US26D	US26DAM	US28	US32
630	630AM	643e	689	691	693	695	706	710	711	721	728
US32D	US32DAM	-	SP28	SPIO	SPBLK	SP313	SP4	313	315	US3A	US4A

Wood Door Concealed vertical rod devices (47-WDC)

ACN							PRICE BASED ON FINISH						Default trim, included			
Device type	Function	Fire	Finish	Device size	Handling	Lever design	626	628	630	710	612	606 ²		605 ² 619 ¹ 625 643E	711	613 ²
EXIT HARDWARE							3' DEVICE PRICING SHOWN. 2' ADD \$78.00 LIST, 4' ADD \$19.00 LIST									
[98/99]47-WDC .	EO	.	[]	.	[]	.	\$2,523	\$2,279	\$2,585	\$2,487	\$2,579	\$2,667	\$2,877	\$3,224	\$2,929	N/A
[98/99]47-WDC .	DT	.	[]	.	[]	.	\$2,792	\$2,548	\$2,854	\$2,769	\$2,861	\$2,884	\$3,171	\$3,506	\$3,211	990DT
[98/99]47-WDC .	NL	.	[]	.	[]	[]	\$2,808	\$2,564	\$2,870	\$2,785	\$2,877	\$2,900	\$3,187	\$3,522	\$3,227	990NL-R/V
[98/99]47-WDC .	NL-OP	.	[]	.	[]	.	\$2,663	\$2,419	\$2,725	\$2,627	\$2,719	\$2,797	\$3,017	\$3,364	\$3,069	110WD
[98/99]47-WDC .	TP	.	[]	.	[]	.	\$2,910	\$2,666	\$2,972	\$2,885	\$2,966	\$2,989	\$3,293	\$3,622	\$3,327	990TP-R/V
[98/99]47-WDC .	TP-BE	.	[]	.	[]	.	\$2,910	\$2,666	\$2,972	\$2,885	\$2,966	\$2,989	\$3,293	\$3,622	\$3,327	990TP-BE-R/V
[98/99]47-WDC .	K	.	[]	.	[]	.	\$2,999	\$2,755	\$3,061	\$2,963	\$3,119	\$3,067	\$3,452	\$3,700	\$3,405	996K-R/V
[98/99]47-WDC .	K-BE	.	[]	.	[]	.	\$2,999	\$2,755	\$3,061	\$2,963	\$3,119	\$3,067	\$3,452	\$3,700	\$3,405	996K-BE-R/V
[98/99]47-WDC .	K-DT	.	[]	.	[]	.	\$2,989	\$2,745	\$3,051	\$2,953	\$3,109	\$3,057	\$3,442	\$3,690	\$3,395	996K-DT-R/V
[98/99]47-WDC .	K-NL	.	[]	.	[]	.	\$2,989	\$2,745	\$3,051	\$2,953	\$3,109	\$3,057	\$3,442	\$3,690	\$3,395	996K-NL-R/V
[98/99]47-WDC .	L	.	[]	.	[]	[]	\$3,142	\$2,898	\$3,204	\$3,106	\$3,253	\$3,255	\$3,578	\$3,843	\$3,570	996L-R/V
[98/99]47-WDC .	L-BE	.	[]	.	[]	[]	\$3,142	\$2,898	\$3,204	\$3,106	\$3,253	\$3,255	\$3,578	\$3,843	\$3,570	996L-BE-R/V
[98/99]47-WDC .	L-DT	.	[]	.	[]	[]	\$3,016	\$2,772	\$3,078	\$2,980	\$3,127	\$3,129	\$3,452	\$3,717	\$3,444	996L-DT-R/V
[98/99]47-WDC .	L-NL	.	[]	.	[]	[]	\$3,016	\$2,772	\$3,078	\$2,980	\$3,127	\$3,129	\$3,452	\$3,717	\$3,444	996L-NL-R/V
[98/99]47-WDC .	TL	.	[]	.	[]	.	\$3,630	\$3,386	\$3,692	\$3,607	\$3,759	\$3,614	\$4,069	\$4,344	\$4,049	990DT/ 376WDC-T/ 10WDA ³
[98/99]47-WDC .	TL-BE	.	[]	.	[]	.	\$3,587	\$3,343	\$3,649	\$3,564	\$3,716	\$3,571	\$4,026	\$4,301	\$4,006	990DT/ 376WDC-T-BE/ 10WDA ³

² Consult factory for lead time.

¹ 630 and 619 finishes available only on 98 Series.

² 613 finish has 710 finish device with 613 parts.

³ Wood doors - the 283 strike or WDF must be specified. Specify door thickness.

DEFAULT ATTRIBUTES

Pricing includes default options shown below. Additional options and configurations available.

Cylinders:	Sex bolts	Door thickness	Center line	Scalp plate
Not included	Included	1-3/4"	39-13/16"	Included

Strike(s):

Exit hardware:

- Includes 338 and 385A strikes

Fire exit hardware:

- Includes 338 and 385A strikes

98/99 SERIES

605	606	611	612	613	619	622	625	626	626AM	628	629
US3	US4	US9	US10	US10B	US15	US19	US26	US26D	US26DAM	US28	US32
630	630AM	643e	689	691	693	695	706	710	711	721	728
US32D	US32DAM	-	SP28	SP10	SPBLK	SP313	SP4	313	315	US3A	US4A

Wood Door Concealed vertical rod devices (47-WDC)

ACN							PRICE BASED ON FINISH						Default trim, included			
Device type	Function	File	Finish	Device size	Handing	Lever design	605 ²	619 ¹	625	606 ²	643E	711		613 ²		
							626	628	630	710	612	606 ²		643E	711	613 ²
FIRE EXIT HARDWARE							3' DEVICE PRICING SHOWN. 2' ADD \$78.00 LIST, 4' ADD \$19.00 LIST									
[98/99]47-WDC . EO . F . [] . []							\$2,920	\$2,676	\$2,982	\$2,884	\$2,976	\$3,064	\$3,274	\$3,621	\$3,326	N/A
[98/99]47-WDC . DT . F . [] . []							\$3,189	\$2,945	\$3,251	\$3,166	\$3,258	\$3,281	\$3,568	\$3,903	\$3,608	990DT
[98/99]47-WDC . NL . F . [] . [] . []							\$3,205	\$2,961	\$3,267	\$3,182	\$3,274	\$3,297	\$3,584	\$3,919	\$3,624	990NL-R/V
[98/99]47-WDC . NL-OP . F . [] . []							\$3,060	\$2,816	\$3,122	\$3,024	\$3,116	\$3,194	\$3,414	\$3,761	\$3,466	110WD
[98/99]47-WDC . TP . F . [] . []							\$3,307	\$3,063	\$3,369	\$3,282	\$3,363	\$3,386	\$3,690	\$4,019	\$3,724	990TP-R/V
[98/99]47-WDC . TP-BE . F . [] . []							\$3,307	\$3,063	\$3,369	\$3,282	\$3,363	\$3,386	\$3,690	\$4,019	\$3,724	990TP-BE-R/V
[98/99]47-WDC . K . F . [] . []							\$3,396	\$3,152	\$3,458	\$3,360	\$3,516	\$3,464	\$3,849	\$4,097	\$3,802	996K-R/V
[98/99]47-WDC . K-BE . F . [] . []							\$3,396	\$3,152	\$3,458	\$3,360	\$3,516	\$3,464	\$3,849	\$4,097	\$3,802	996K-BE-R/V
[98/99]47-WDC . K-NL . F . [] . []							\$3,386	\$3,142	\$3,448	\$3,350	\$3,506	\$3,454	\$3,839	\$4,087	\$3,792	996K-NL-R/V
[98/99]47-WDC . L . F . [] . [] . [] . []							\$3,539	\$3,295	\$3,601	\$3,503	\$3,650	\$3,652	\$3,975	\$4,240	\$3,967	996L-R/V
[98/99]47-WDC . L-BE . F . [] . [] . [] . []							\$3,539	\$3,295	\$3,601	\$3,503	\$3,650	\$3,652	\$3,975	\$4,240	\$3,967	996L-BE-R/V
[98/99]47-WDC . L-NL . F . [] . [] . [] . []							\$3,413	\$3,169	\$3,475	\$3,377	\$3,524	\$3,526	\$3,849	\$4,114	\$3,841	996L-NL-R/V
[98/99]47-WDC . TL . F . [] . []							\$4,027	\$3,783	\$4,089	\$4,004	\$4,156	\$4,011	\$4,466	\$4,741	\$4,446	990DT/ 376WDC-T/ 10WDA ³
[98/99]47-WDC . TL-BE . F . [] . []							\$3,984	\$3,740	\$4,046	\$3,961	\$4,113	\$3,968	\$4,423	\$4,698	\$4,403	990DT/ 376WDC-T-BE/ 10WDA ³

² Consult factory for lead time.

¹ 630 and 619 finishes available only on 98 Series.

² 613 finish has 710 finish device with 613 parts.

³ Wood doors - the 283 strike or WDF must be specified. Specify door thickness.

DEFAULT ATTRIBUTES

Pricing includes default options shown below. Additional options and configurations available.

Cylinders:	Sex bolts	Door thickness	Center line	Scalp plate
Not included	Included	1-3/4"	39-13/16"	Included

Strike(s):

Exit hardware:

- Includes 338 and 385A strikes

Fire exit hardware:

- Includes 338 and 385A strikes

98/99 SERIES

605	606	611	612	613	619	622	625	626	626AM	628	629
US3	US4	US9	US10	US10B	US15	US19	US26	US26D	US26DAM	US28	US32
630	630AM	643e	689	691	693	695	706	710	711	721	728
US32D	US32DAM	-	SP28	SPIO	SPBLK	SP313	SP4	313	315	US3A	US4A

Concealed vertical rod devices (48)

ACN							PRICE BASED ON FINISH							Default trim, Included		
Device type	Function	Fire	Finish	Device size	Handing	Lever design	626	628	630	710	612	606 ²	605 ² 619 ¹ 625 643E		711	613 ²
EXIT HARDWARE							3' DEVICE PRICING SHOWN. 2' ADD \$78.00 LIST, 4' ADD \$19.00 LIST									
[98/99]48 . EO . [] . [] .							\$2,600	\$2,356	\$2,662	\$2,538	\$2,630	\$2,718	\$2,864	\$3,275	\$3,049	N/A
[98/99]48 . DT . [] . [] .							\$2,869	\$2,625	\$2,931	\$2,820	\$2,912	\$2,935	\$3,158	\$3,557	\$3,331	990DT
[98/99]48 . NL . [] . [] . []							\$2,885	\$2,641	\$2,947	\$2,836	\$2,928	\$2,951	\$3,174	\$3,573	\$3,347	990NL-R/V
[98/99]48 . NL-OP . [] . [] .							\$2,740	\$2,496	\$2,802	\$2,678	\$2,770	\$2,848	\$3,004	\$3,415	\$3,189	110MD
[98/99]48 . TP . [] . [] .							\$2,987	\$2,743	\$3,049	\$2,936	\$3,017	\$3,040	\$3,280	\$3,673	\$3,447	990TP-R/V
[98/99]48 . TP-BE . [] . [] .							\$2,987	\$2,743	\$3,049	\$2,936	\$3,017	\$3,040	\$3,280	\$3,673	\$3,447	990TP-BE-R/V
[98/99]48 . K . [] . [] .							\$3,076	\$2,832	\$3,138	\$3,014	\$3,170	\$3,118	\$3,439	\$3,751	\$3,525	996K-R/V
[98/99]48 . K-BE . [] . [] .							\$3,076	\$2,832	\$3,138	\$3,014	\$3,170	\$3,118	\$3,439	\$3,751	\$3,525	996K-BE-R/V
[98/99]48 . K-DT . [] . [] .							\$3,066	\$2,822	\$3,128	\$3,004	\$3,160	\$3,108	\$3,429	\$3,741	\$3,515	996K-DT-R/V
[98/99]48 . K-NL . [] . [] .							\$3,066	\$2,822	\$3,128	\$3,004	\$3,160	\$3,108	\$3,429	\$3,741	\$3,515	996K-NL-R/V
[98/99]48 . L . [] . [] . [] . []							\$3,219	\$2,975	\$3,281	\$3,157	\$3,304	\$3,306	\$3,565	\$3,894	\$3,690	996L-R/V
[98/99]48 . L-BE . [] . [] . [] . []							\$3,219	\$2,975	\$3,281	\$3,157	\$3,304	\$3,306	\$3,565	\$3,894	\$3,690	996L-BE-R/V
[98/99]48 . L-DT . [] . [] . [] . []							\$3,093	\$2,849	\$3,155	\$3,031	\$3,178	\$3,180	\$3,439	\$3,768	\$3,564	996L-DT-R/V
[98/99]48 . L-NL . [] . [] . [] . []							\$3,093	\$2,849	\$3,155	\$3,031	\$3,178	\$3,180	\$3,439	\$3,768	\$3,564	996L-NL-R/V
[98/99]48 . TL . [] . []							\$3,651	\$3,407	\$3,713	\$3,602	\$3,754	\$3,609	\$4,000	\$4,339	\$4,113	990DT/376T
[98/99]48 . TL-BE . [] . []							\$3,608	\$3,364	\$3,670	\$3,559	\$3,711	\$3,566	\$3,957	\$4,296	\$4,070	990DT/376T-BE
FIRE EXIT HARDWARE							3' DEVICE PRICING SHOWN. 2' ADD \$78.00 LIST, 4' ADD \$19.00 LIST									
[98/99]48 . EO . F . [] . []							\$2,951	\$2,707	\$3,013	\$2,889	\$2,981	\$3,069	\$3,215	\$3,626	\$3,400	N/A
[98/99]48 . DT . F . [] . []							\$3,220	\$2,976	\$3,282	\$3,171	\$3,263	\$3,286	\$3,509	\$3,908	\$3,682	990DT
[98/99]48 . NL . F . [] . [] . []							\$3,236	\$2,992	\$3,298	\$3,187	\$3,279	\$3,302	\$3,525	\$3,924	\$3,698	990NL-R/V
[98/99]48 . NL-OP . F . [] . []							\$3,091	\$2,847	\$3,153	\$3,029	\$3,121	\$3,199	\$3,355	\$3,766	\$3,540	110MD
[98/99]48 . TP . F . [] . []							\$3,338	\$3,094	\$3,400	\$3,287	\$3,368	\$3,391	\$3,631	\$4,024	\$3,798	990TP-R/V
[98/99]48 . TP-BE . F . [] . []							\$3,338	\$3,094	\$3,400	\$3,287	\$3,368	\$3,391	\$3,631	\$4,024	\$3,798	990TP-BE-R/V
[98/99]48 . K . F . [] . []							\$3,427	\$3,183	\$3,489	\$3,365	\$3,521	\$3,469	\$3,790	\$4,102	\$3,876	996K-R/V
[98/99]48 . K-BE . F . [] . []							\$3,427	\$3,183	\$3,489	\$3,365	\$3,521	\$3,469	\$3,790	\$4,102	\$3,876	996K-BE-R/V
[98/99]48 . K-NL . F . [] . []							\$3,417	\$3,173	\$3,479	\$3,355	\$3,511	\$3,459	\$3,780	\$4,092	\$3,866	996K-NL-R/V
[98/99]48 . L . F . [] . [] . [] . []							\$3,570	\$3,326	\$3,632	\$3,508	\$3,655	\$3,657	\$3,916	\$4,245	\$4,041	996L-R/V
[98/99]48 . L-BE . F . [] . [] . [] . []							\$3,570	\$3,326	\$3,632	\$3,508	\$3,655	\$3,657	\$3,916	\$4,245	\$4,041	996L-BE-R/V
[98/99]48 . L-NL . F . [] . [] . [] . []							\$3,444	\$3,200	\$3,506	\$3,382	\$3,529	\$3,531	\$3,790	\$4,119	\$3,915	996L-NL-R/V
[98/99]48 . TL . F . [] . []							\$4,002	\$3,758	\$4,064	\$3,953	\$4,105	\$3,960	\$4,351	\$4,690	\$4,464	990DT/376T
[98/99]48 . TL-BE . F . [] . []							\$3,959	\$3,715	\$4,021	\$3,910	\$4,062	\$3,917	\$4,308	\$4,647	\$4,421	990DT/376T-BE

² Consult factory for lead time.

¹ 630 and 619 finishes available only on 98 Series.

² 613 finish has 710 finish device with 613 parts.

DEFAULT ATTRIBUTES

Pricing includes default options shown below. Additional options and configurations available.

Cylinders:	Sex bolts	Door thickness	Center line
Not included	Not included	1-3/4"	39-13/16"

Strike(s): Exit hardware:
 ■ Includes 338 and 385A strikes

Fire exit hardware:
 ■ Includes 338 and 385A strikes

22 SERIES
33A/35A SERIES
55 SERIES
88 SERIES
98/99 SERIES
XP98/XP99 SERIES
94/95 SERIES
GUARD-X SERIES
ACCESSORIES / PARTS
ELECTRICAL / PARTS

98/99 SERIES

605	606	611	612	613	619	622	625	626	626AM	628	629
US3	US4	US9	US10	US10B	US15	US19	US26	US26D	US26DAM	US28	US32
630	630AM	643e	689	691	693	695	706	710	711	721	728
US32D	US32DAM	-	SP28	SPI0	SPBLK	SP313	SP4	313	315	US3A	US4A

Surface three point latch devices (57)

ACN							PRICE BASED ON FINISH							Default trim, included		
Device type	Function	Fire	Finish	Device size	Handing	Lever design	626	628	630	710	612	606 ²	605 ² 619 ¹ 625 643E		711	613 ²
EXIT HARDWARE							3' DEVICE PRICING SHOWN. 2' ADD \$78.00 LIST, 4' ADD \$19.00 LIST									
[98/99]57	EO	.	[]	.	[]	.	\$2,913	\$2,677	\$3,060	\$2,859	\$2,996	\$3,085	\$3,245	\$3,596	\$3,412	N/A
[98/99]57	DT	.	[]	.	[]	.	\$3,182	\$2,946	\$3,329	\$3,141	\$3,278	\$3,302	\$3,539	\$3,878	\$3,694	990DT
[98/99]57	NL	.	[]	.	[]	.	\$3,198	\$2,962	\$3,345	\$3,157	\$3,294	\$3,318	\$3,555	\$3,894	\$3,710	990NL-R/V
[98/99]57	NL-OP	.	[]	.	[]	.	\$3,053	\$2,817	\$3,200	\$2,999	\$3,136	\$3,215	\$3,385	\$3,736	\$3,552	110MD/WD
[98/99]57	TP	.	[]	.	[]	.	\$3,300	\$3,064	\$3,447	\$3,257	\$3,383	\$3,407	\$3,661	\$3,994	\$3,810	990TP-R/V
[98/99]57	TP-BE	.	[]	.	[]	.	\$3,300	\$3,064	\$3,447	\$3,257	\$3,383	\$3,407	\$3,661	\$3,994	\$3,810	990TP-BE-R/V
[98/99]57	K	.	[]	.	[]	.	\$3,389	\$3,153	\$3,536	\$3,335	\$3,536	\$3,485	\$3,820	\$4,072	\$3,888	996K-R/V
[98/99]57	K-BE	.	[]	.	[]	.	\$3,389	\$3,153	\$3,536	\$3,335	\$3,536	\$3,485	\$3,820	\$4,072	\$3,888	996K-BE-R/V
[98/99]57	K-DT	.	[]	.	[]	.	\$3,379	\$3,143	\$3,526	\$3,325	\$3,526	\$3,475	\$3,810	\$4,062	\$3,878	996K-DT-R/V
[98/99]57	K-NL	.	[]	.	[]	.	\$3,379	\$3,143	\$3,526	\$3,325	\$3,526	\$3,475	\$3,810	\$4,062	\$3,878	996K-NL-R/V
[98/99]57	L	.	[]	.	[]	.	\$3,532	\$3,296	\$3,679	\$3,478	\$3,670	\$3,673	\$3,946	\$4,215	\$4,053	996L-R/V
[98/99]57	L-BE	.	[]	.	[]	.	\$3,532	\$3,296	\$3,679	\$3,478	\$3,670	\$3,673	\$3,946	\$4,215	\$4,053	996L-BE-R/V
[98/99]57	L-DT	.	[]	.	[]	.	\$3,406	\$3,170	\$3,553	\$3,352	\$3,544	\$3,547	\$3,820	\$4,089	\$3,927	996L-DT-R/V
[98/99]57	L-NL	.	[]	.	[]	.	\$3,406	\$3,170	\$3,553	\$3,352	\$3,544	\$3,547	\$3,820	\$4,089	\$3,927	996L-NL-R/V
[98/99]57	TL	.	[]	.	[]	.	\$3,964	\$3,728	\$4,111	\$3,923	\$4,120	\$3,976	\$4,381	\$4,660	\$4,476	990DT/374T*
[98/99]57	TL-BE	.	[]	.	[]	.	\$3,921	\$3,685	\$4,068	\$3,880	\$4,077	\$3,933	\$4,338	\$4,617	\$4,433	990DT/374T-BE*
FIRE EXIT HARDWARE							3' DEVICE PRICING SHOWN. 2' ADD \$78.00 LIST, 4' ADD \$19.00 LIST									
[98/99]57	EO	.	F	.	[]	.	\$3,112	\$2,876	\$3,259	\$3,058	\$3,195	\$3,284	\$3,444	\$3,795	\$3,611	N/A
[98/99]57	DT	.	F	.	[]	.	\$3,381	\$3,145	\$3,528	\$3,340	\$3,477	\$3,501	\$3,738	\$4,077	\$3,893	990DT
[98/99]57	NL	.	F	.	[]	.	\$3,397	\$3,161	\$3,544	\$3,356	\$3,493	\$3,517	\$3,754	\$4,093	\$3,909	990NL-R/V
[98/99]57	NL-OP	.	F	.	[]	.	\$3,252	\$3,016	\$3,399	\$3,198	\$3,335	\$3,414	\$3,584	\$3,935	\$3,751	110MD/WD
[98/99]57	TP	.	F	.	[]	.	\$3,499	\$3,263	\$3,646	\$3,456	\$3,582	\$3,606	\$3,860	\$4,193	\$4,009	990TP-R/V
[98/99]57	TP-BE	.	F	.	[]	.	\$3,499	\$3,263	\$3,646	\$3,456	\$3,582	\$3,606	\$3,860	\$4,193	\$4,009	990TP-BE-R/V
[98/99]57	K	.	F	.	[]	.	\$3,588	\$3,352	\$3,735	\$3,534	\$3,735	\$3,684	\$4,019	\$4,271	\$4,087	996K-R/V
[98/99]57	K-BE	.	F	.	[]	.	\$3,588	\$3,352	\$3,735	\$3,534	\$3,735	\$3,684	\$4,019	\$4,271	\$4,087	996K-BE-R/V
[98/99]57	K-NL	.	F	.	[]	.	\$3,578	\$3,342	\$3,725	\$3,524	\$3,725	\$3,674	\$4,009	\$4,261	\$4,077	996K-NL-R/V
[98/99]57	L	.	F	.	[]	.	\$3,731	\$3,495	\$3,878	\$3,677	\$3,869	\$3,872	\$4,145	\$4,414	\$4,252	996L-R/V
[98/99]57	L-BE	.	F	.	[]	.	\$3,731	\$3,495	\$3,878	\$3,677	\$3,869	\$3,872	\$4,145	\$4,414	\$4,252	996L-BE-R/V
[98/99]57	L-NL	.	F	.	[]	.	\$3,605	\$3,369	\$3,752	\$3,551	\$3,743	\$3,746	\$4,019	\$4,288	\$4,126	996L-NL-R/V
[98/99]57	TL	.	F	.	[]	.	\$4,163	\$3,927	\$4,310	\$4,122	\$4,319	\$4,175	\$4,580	\$4,859	\$4,675	990DT/374T ³
[98/99]57	TL-BE	.	F	.	[]	.	\$4,120	\$3,884	\$4,267	\$4,079	\$4,276	\$4,132	\$4,537	\$4,816	\$4,632	990DT/374T-BE ³

² Consult factory for lead time.

¹ 630 and 619 finishes available only on 98 Series.

² 613 finish has 710 finish device with 613 parts.

³ Wood doors - 10WDA cover plate is required for the 370 series controls and will be supplied at an additional, \$56 list add.

DEFAULT ATTRIBUTES

Pricing includes default options shown below. Additional options and configurations available.

Cylinders:	Sex bolts	Door thickness	Center line
Not included	Included for latches	1-3/4"	39-13/16"

Strike(s): Exit hardware:

- Includes 299(2), 248L-4, 304L strikes and sex bolts for latches

Fire exit hardware:

- Includes 299(2), 304L strikes and sex bolts for latches
- For double door applications, the 499F Strike will be supplied for middle strike at an additional \$112 list add

98/99 SERIES

605	606	611	612	613	619	622	625	626	626AM	628	629
US3	US4	US9	US10	US10B	US15	US19	US26	US26D	US26DAM	US28	US32
630	630AM	643e	689	691	693	695	706	710	711	721	728
US32D	US32DAM	-	SP28	SPI0	SPBLK	SP313	SP4	313	315	US3A	US4A

Mortise lock devices (75)

ACN							PRICE BASED ON FINISH							Default trim, included		
Device type	Function	Fire	Finish	Device size	Handing	Lever design	605 ² 619 ¹ 625 643E									
							626	628	630	710	612	606 ²	711		613 ²	
EXIT HARDWARE							3' DEVICE PRICING SHOWN. 2' ADD \$78.00 LIST, 4' ADD \$19.00 LIST									
[98/99]75 . EO . [] . [] .							\$2,094	\$1,926	\$2,156	\$2,003	\$2,163	\$2,163	\$2,402	\$2,740	\$2,314	N/A
[98/99]75 . HL . [] . [] .							\$2,313	\$2,145	\$2,375	\$2,231	\$2,391	\$2,391	\$2,630	\$3,022	\$2,596	N/A
[98/99]75 . DT . [] . [] .							\$2,363	\$2,195	\$2,425	\$2,285	\$2,445	\$2,380	\$2,696	\$2,959	\$2,542	990DT
[98/99]75 . NL . [] . [] . []							\$2,379	\$2,211	\$2,441	\$2,301	\$2,461	\$2,396	\$2,712	\$3,038	\$2,612	990NL-M
[98/99]75 . TP . [] . [] .							\$2,481	\$2,313	\$2,543	\$2,401	\$2,550	\$2,485	\$2,818	\$3,138	\$2,712	990TP-M
[98/99]75 . TP-BE . [] . [] .							\$2,481	\$2,313	\$2,543	\$2,401	\$2,550	\$2,485	\$2,818	\$3,138	\$2,712	990TP-BE-M
[98/99]75 . K . [] . [] .							\$2,570	\$2,402	\$2,632	\$2,479	\$2,703	\$2,563	\$2,977	\$3,216	\$2,790	996K-M
[98/99]75 . K-BE . [] . [] .							\$2,570	\$2,402	\$2,632	\$2,479	\$2,703	\$2,563	\$2,977	\$3,216	\$2,790	996K-BE-M
[98/99]75 . K-DT . [] . [] .							\$2,560	\$2,392	\$2,622	\$2,469	\$2,693	\$2,553	\$2,967	\$3,206	\$2,780	996K-DT-M
[98/99]75 . K-NL . [] . [] .							\$2,560	\$2,392	\$2,622	\$2,469	\$2,693	\$2,553	\$2,967	\$3,206	\$2,780	996K-NL-M
[98/99]75 . L . [] . [] . [] . []							\$2,713	\$2,545	\$2,775	\$2,622	\$2,837	\$2,751	\$3,103	\$3,359	\$2,955	996L-M
[98/99]75 . L-BE . [] . [] . [] . []							\$2,713	\$2,545	\$2,775	\$2,622	\$2,837	\$2,751	\$3,103	\$3,359	\$2,955	996L-BE-M
[98/99]75 . L-DT . [] . [] . [] . []							\$2,587	\$2,419	\$2,649	\$2,496	\$2,711	\$2,625	\$2,977	\$3,233	\$2,829	996L-DT-M
[98/99]75 . L-NL . [] . [] . [] . []							\$2,587	\$2,419	\$2,649	\$2,496	\$2,711	\$2,625	\$2,977	\$3,233	\$2,829	996L-NL-M
FIRE EXIT HARDWARE							3' DEVICE PRICING SHOWN. 2' ADD \$78.00 LIST, 4' ADD \$19.00 LIST									
[98/99]75 . EO . F . [] . []							\$2,320	\$2,152	\$2,382	\$2,229	\$2,389	\$2,389	\$2,628	\$2,966	\$2,540	N/A
[98/99]75 . DT . F . [] . []							\$2,589	\$2,421	\$2,651	\$2,511	\$2,671	\$2,606	\$2,922	\$3,248	\$2,822	990DT
[98/99]75 . HL . F . [] . []							\$2,539	\$2,371	\$2,601	\$2,457	\$2,617	\$2,617	\$2,856	\$3,185	\$2,768	N/A
[98/99]75 . NL . F . [] . [] . []							\$2,605	\$2,437	\$2,667	\$2,527	\$2,687	\$2,622	\$2,938	\$3,264	\$2,838	990NL-M
[98/99]75 . TP . F . [] . []							\$2,707	\$2,539	\$2,769	\$2,627	\$2,776	\$2,711	\$3,044	\$3,364	\$2,938	990TP-M
[98/99]75 . TP-BE . F . [] . []							\$2,707	\$2,539	\$2,769	\$2,627	\$2,776	\$2,711	\$3,044	\$3,364	\$2,938	990TP-BE-M
[98/99]75 . K . F . [] . []							\$2,796	\$2,628	\$2,858	\$2,705	\$2,929	\$2,789	\$3,203	\$3,442	\$3,016	996K-M
[98/99]75 . K-BE . F . [] . []							\$2,796	\$2,628	\$2,858	\$2,705	\$2,929	\$2,789	\$3,203	\$3,442	\$3,016	996K-BE-M
[98/99]75 . K-NL . F . [] . []							\$2,786	\$2,618	\$2,848	\$2,695	\$2,919	\$2,779	\$3,193	\$3,432	\$3,006	996K-NL-M
[98/99]75 . L . F . [] . [] . [] . []							\$2,939	\$2,771	\$3,001	\$2,848	\$3,063	\$2,977	\$3,329	\$3,585	\$3,181	996L-M
[98/99]75 . L-BE . F . [] . [] . [] . []							\$2,939	\$2,771	\$3,001	\$2,848	\$3,063	\$2,977	\$3,329	\$3,585	\$3,181	996L-BE-M
[98/99]75 . L-NL . F . [] . [] . [] . []							\$2,813	\$2,645	\$2,875	\$2,722	\$2,937	\$2,851	\$3,203	\$3,459	\$3,055	996L-NL-M

² Consult factory for lead time.

¹ 630 and 619 finishes available only on 98 Series.

² 613 finish has 710 finish device with 613 parts.

DEFAULT ATTRIBUTES

Pricing includes default options shown below. Additional options and configurations available.

Cylinders:	Sex bolts	Door thickness	Center line
Not included	Not included	1-3/4"	39-13/16"

Strike(s):

Exit hardware:

- Includes 575 strike

Fire exit hardware:

- Includes 575 strike

98/99 SERIES

605	606	611	612	613	619	622	625	626	626AM	628	629
US3	US4	US9	US10	US10B	US15	US19	US26	US26D	US26DAM	US28	US32
630	630AM	643e	689	691	693	695	706	710	711	721	728
US32D	US32DAM	-	SP28	SPI0	SPBLK	SP313	SP4	313	315	US3A	US4A

Concealed vertical cable devices (49)

Prices shown are for door opening heights 6'0" -10'0"

ACN							PRICE BASED ON FINISH							Default trim, included		
Device type	Function	Fire	Finish	Device size	Handling	Lever design	605 [Ⓜ] 619 ¹ 625 643E									
							626	628	630	710	612	606 [Ⓜ]	711		613 ²	
EXIT HARDWARE							3' DEVICE PRICING SHOWN. 2' ADD \$78.00 LIST, 4' ADD \$19.00 LIST									
[98/99]49 . EO . [] . [] .							\$2,262	\$2,018	\$2,324	\$2,200	\$2,292	\$2,380	\$2,526	\$2,937	\$2,711	N/A
[98/99]49 . DT . [] . [] .							\$2,531	\$2,287	\$2,593	\$2,482	\$2,574	\$2,597	\$2,820	\$3,219	\$2,993	990DT
[98/99]49 . NL . [] . [] . []							\$2,547	\$2,303	\$2,609	\$2,498	\$2,590	\$2,613	\$2,836	\$3,235	\$3,009	990NL-R/V
[98/99]49 . NL-OP . [] . [] .							\$2,402	\$2,158	\$2,464	\$2,340	\$2,432	\$2,510	\$2,666	\$3,077	\$2,851	110MD
[98/99]49 . TP . [] . [] .							\$2,649	\$2,405	\$2,711	\$2,598	\$2,679	\$2,702	\$2,942	\$3,335	\$3,109	990TP-R/V
[98/99]49 . TP-BE . [] . [] .							\$2,649	\$2,405	\$2,711	\$2,598	\$2,679	\$2,702	\$2,942	\$3,335	\$3,109	990TP-BE-R/V
[98/99]49 . K . [] . [] .							\$2,738	\$2,494	\$2,800	\$2,676	\$2,832	\$2,780	\$3,101	\$3,413	\$3,187	996K-R/V
[98/99]49 . K-BE . [] . [] .							\$2,738	\$2,494	\$2,800	\$2,676	\$2,832	\$2,780	\$3,101	\$3,413	\$3,187	996K-BE-R/V
[98/99]49 . K-DT . [] . [] .							\$2,728	\$2,484	\$2,790	\$2,666	\$2,822	\$2,770	\$3,091	\$3,403	\$3,177	996K-DT-R/V
[98/99]49 . K-NL . [] . [] .							\$2,728	\$2,484	\$2,790	\$2,666	\$2,822	\$2,770	\$3,091	\$3,403	\$3,177	996K-NL-R/V
[98/99]49 . L . [] . [] . [] . []							\$2,881	\$2,637	\$2,943	\$2,819	\$2,966	\$2,968	\$3,227	\$3,556	\$3,352	996L-R/V
[98/99]49 . L-BE . [] . [] . [] . []							\$2,881	\$2,637	\$2,943	\$2,819	\$2,966	\$2,968	\$3,227	\$3,556	\$3,352	996L-BE-R/V
[98/99]49 . L-DT . [] . [] . [] . []							\$2,755	\$2,511	\$2,817	\$2,693	\$2,840	\$2,842	\$3,101	\$3,430	\$3,226	996L-DT-R/V
[98/99]49 . L-NL . [] . [] . [] . []							\$2,755	\$2,511	\$2,817	\$2,693	\$2,840	\$2,842	\$3,101	\$3,430	\$3,226	996L-NL-R/V
FIRE EXIT HARDWARE							3' DEVICE PRICING SHOWN. 2' ADD \$78.00 LIST, 4' ADD \$19.00 LIST									
[98/99]49 . EO . F . [] . []							\$2,485	\$2,241	\$2,547	\$2,423	\$2,515	\$2,603	\$2,749	\$3,160	\$2,934	N/A
[98/99]49 . DT . F . [] . []							\$2,754	\$2,510	\$2,816	\$2,705	\$2,797	\$2,820	\$3,043	\$3,442	\$3,216	990DT
[98/99]49 . NL . F . [] . [] . []							\$2,770	\$2,526	\$2,832	\$2,721	\$2,813	\$2,836	\$3,059	\$3,458	\$3,232	990NL-R/V
[98/99]49 . NL-OP . F . [] . []							\$2,625	\$2,381	\$2,687	\$2,563	\$2,655	\$2,733	\$2,889	\$3,300	\$3,074	110MD/WD
[98/99]49 . TP . F . [] . []							\$2,872	\$2,628	\$2,934	\$2,821	\$2,902	\$2,925	\$3,165	\$3,558	\$3,332	990TP-R/V
[98/99]49 . TP-BE . F . [] . []							\$2,872	\$2,628	\$2,934	\$2,821	\$2,902	\$2,925	\$3,165	\$3,558	\$3,332	990TP-BE-R/V
[98/99]49 . K . F . [] . []							\$2,961	\$2,717	\$3,023	\$2,899	\$3,055	\$3,003	\$3,324	\$3,636	\$3,410	996K-R/V
[98/99]49 . K-BE . F . [] . []							\$2,961	\$2,717	\$3,023	\$2,899	\$3,055	\$3,003	\$3,324	\$3,636	\$3,410	996K-BE-R/V
[98/99]49 . K-NL . F . [] . []							\$2,951	\$2,707	\$3,013	\$2,889	\$3,045	\$2,993	\$3,314	\$3,626	\$3,400	996K-NL-R/V
[98/99]49 . L . F . [] . [] . [] . []							\$3,104	\$2,860	\$3,166	\$3,042	\$3,189	\$3,191	\$3,450	\$3,779	\$3,575	996L-R/V
[98/99]49 . L-BE . F . [] . [] . [] . []							\$3,104	\$2,860	\$3,166	\$3,042	\$3,189	\$3,191	\$3,450	\$3,779	\$3,575	996L-BE-R/V
[98/99]49 . L-NL . F . [] . [] . [] . []							\$2,978	\$2,734	\$3,040	\$2,916	\$3,063	\$3,065	\$3,324	\$3,653	\$3,449	996L-NL-R/V

For Devices Less Cable System (LCS) Deduct \$1,036

[Ⓜ] Consult factory for lead time.

¹ 630 and 619 finishes available only on 98 Series.

² 613 finish has 710 finish device with 613 parts.

DEFAULT ATTRIBUTES

Pricing includes default options shown below. Additional options and configurations available.

Cylinders:	Sex bolts	Door thickness	Door opening height
Not included	Not included	1-3/4"	6'10' - 10' Specify door opening height if other than 6'10' - 10'.
For door opening heights more than 10', consult factory			

Strike(s): Exit hardware: Fire exit hardware:
▪ Includes 249 and 349 Strikes ▪ Includes 249 and 349 Strikes

98/99 SERIES

605	606	611	612	613	619	622	625	626	626AM	628	629
US3	US4	US9	US10	US10B	US15	US19	US26	US26D	US26DAM	US28	US32
630	630AM	643e	689	691	693	695	706	710	711	721	728
US32D	US32DAM	-	SP28	SPIO	SPBLK	SP313	SP4	313	315	US3A	US4A

Wood Door Concealed vertical cable devices (50-WDC)

Prices shown are for door opening heights 6'0" -10'0"

ACN							PRICE BASED ON FINISH							Default trim, Included		
Device type	Function	Fire	Finish	Device size	Handing	Lever design	605 ² 619 ¹ 625 643e									
							626	628	630	710	612	606 ²	711		613 ²	
EXIT HARDWARE							3' DEVICE PRICING SHOWN. 2' ADD \$78.00 LIST, 4' ADD \$19.00 LIST									
[98/99]50-WDC .	EO	.	[]	[]	[]	.	\$2,412	\$2,170	\$2,469	\$2,343	\$2,432	\$2,514	\$2,694	\$3,064	\$2,870	N/A
[98/99]50-WDC .	DT	.	[]	[]	[]	.	\$2,681	\$2,439	\$2,738	\$2,625	\$2,714	\$2,731	\$2,988	\$3,346	\$3,152	990DT
[98/99]50-WDC .	NL	.	[]	[]	[]	[]	\$2,697	\$2,455	\$2,754	\$2,641	\$2,730	\$2,747	\$3,004	\$3,362	\$3,168	990NL-R/V
[98/99]50-WDC .	NL-OP	.	[]	[]	[]	.	\$2,552	\$2,310	\$2,609	\$2,483	\$2,572	\$2,644	\$2,834	\$3,204	\$3,010	110WD
[98/99]50-WDC .	TP	.	[]	[]	[]	.	\$2,799	\$2,557	\$2,856	\$2,741	\$2,819	\$2,836	\$3,110	\$3,462	\$3,268	990TP-R/V
[98/99]50-WDC .	TP-BE	.	[]	[]	[]	.	\$2,799	\$2,557	\$2,856	\$2,741	\$2,819	\$2,836	\$3,110	\$3,462	\$3,268	990TP-BE-R/V
[98/99]50-WDC .	K	.	[]	[]	[]	.	\$2,888	\$2,646	\$2,945	\$2,819	\$2,972	\$2,914	\$3,269	\$3,540	\$3,346	996K-R/V
[98/99]50-WDC .	K-BE	.	[]	[]	[]	.	\$2,888	\$2,646	\$2,945	\$2,819	\$2,972	\$2,914	\$3,269	\$3,540	\$3,346	996K-BE-R/V
[98/99]50-WDC .	K-DT	.	[]	[]	[]	.	\$2,878	\$2,636	\$2,935	\$2,809	\$2,962	\$2,904	\$3,259	\$3,530	\$3,336	996K-DT-R/V
[98/99]50-WDC .	K-NL	.	[]	[]	[]	.	\$2,878	\$2,636	\$2,935	\$2,809	\$2,962	\$2,904	\$3,259	\$3,530	\$3,336	996K-NL-R/V
[98/99]50-WDC .	L	.	[]	[]	[]	[]	\$3,031	\$2,789	\$3,088	\$2,962	\$3,106	\$3,102	\$3,395	\$3,683	\$3,511	996L-R/V
[98/99]50-WDC .	L-BE	.	[]	[]	[]	[]	\$3,031	\$2,789	\$3,088	\$2,962	\$3,106	\$3,102	\$3,395	\$3,683	\$3,511	996L-BE-R/V
[98/99]50-WDC .	L-DT	.	[]	[]	[]	[]	\$2,905	\$2,663	\$2,962	\$2,836	\$2,980	\$2,976	\$3,269	\$3,557	\$3,385	996L-DT-R/V
[98/99]50-WDC .	L-NL	.	[]	[]	[]	[]	\$2,905	\$2,663	\$2,962	\$2,836	\$2,980	\$2,976	\$3,269	\$3,557	\$3,385	996L-NL-R/V

For Devices Less Cable System (LCS) Deduct \$1,186

FIRE EXIT HARDWARE							3' DEVICE PRICING SHOWN. 2' ADD \$78.00 LIST, 4' ADD \$19.00 LIST							Default trim, Included		
Device type	Function	Fire	Finish	Device size	Handing	Lever design	605 ² 619 ¹ 625 643e									
							626	628	630	710	612	606 ²	711		613 ²	
[98/99]50-WDC .	EO	.	F	[]	[]	.	\$2,722	\$2,480	\$2,779	\$2,653	\$2,742	\$2,824	\$3,004	\$3,374	\$3,180	N/A
[98/99]50-WDC .	DT	.	F	[]	[]	.	\$2,991	\$2,749	\$3,048	\$2,935	\$3,024	\$3,041	\$3,298	\$3,656	\$3,462	990DT
[98/99]50-WDC .	NL	.	F	[]	[]	[]	\$3,007	\$2,765	\$3,064	\$2,951	\$3,040	\$3,057	\$3,314	\$3,672	\$3,478	990NL-R/V
[98/99]50-WDC .	NL-OP	.	F	[]	[]	.	\$2,862	\$2,620	\$2,919	\$2,793	\$2,882	\$2,954	\$3,144	\$3,514	\$3,320	110WD
[98/99]50-WDC .	TP-BE	.	F	[]	[]	.	\$3,109	\$2,867	\$3,166	\$3,051	\$3,129	\$3,146	\$3,420	\$3,772	\$3,578	990TP-BE-R/V
[98/99]50-WDC .	TP	.	F	[]	[]	.	\$3,109	\$2,867	\$3,166	\$3,051	\$3,129	\$3,146	\$3,420	\$3,772	\$3,578	990TP-R/V
[98/99]50-WDC .	K	.	F	[]	[]	.	\$3,198	\$2,956	\$3,255	\$3,129	\$3,282	\$3,224	\$3,579	\$3,850	\$3,656	996K-R/V
[98/99]50-WDC .	K-BE	.	F	[]	[]	.	\$3,198	\$2,956	\$3,255	\$3,129	\$3,282	\$3,224	\$3,579	\$3,850	\$3,656	996K-BE-R/V
[98/99]50-WDC .	K-NL	.	F	[]	[]	.	\$3,188	\$2,946	\$3,245	\$3,119	\$3,272	\$3,214	\$3,569	\$3,840	\$3,646	996K-NL-R/V
[98/99]50-WDC .	L	.	F	[]	[]	[]	\$3,341	\$3,099	\$3,398	\$3,272	\$3,416	\$3,412	\$3,705	\$3,993	\$3,821	996L-R/V
[98/99]50-WDC .	L-BE	.	F	[]	[]	[]	\$3,341	\$3,099	\$3,398	\$3,272	\$3,416	\$3,412	\$3,705	\$3,993	\$3,821	996L-BE-R/V
[98/99]50-WDC .	L-NL	.	F	[]	[]	[]	\$3,215	\$2,973	\$3,272	\$3,146	\$3,290	\$3,286	\$3,579	\$3,867	\$3,695	996L-NL-R/V

For Devices Less Cable System (LCS) Deduct \$1,498

² Consult factory for lead time.

¹ 630 and 619 finishes available only on 98 Series.

² 613 finish has 710 finish device with 613 parts.

Door opening height - must be specified when placing an order. Other heights over 10' are available, consult factory for lead time. Non-standard center lines or threshold installed - consult customer support.

DEFAULT ATTRIBUTES

Pricing includes default options shown below. Additional options and configurations available.

Cylinders:	Sex bolts	Door thickness	Scalp plate
Not included	Included	1-3/4"	Included

- Strike(s):** Exit hardware:
 ■ Includes 150 and 450 strikes
- Fire exit hardware:
 ■ Includes 150 and 450 strikes

98/99 SERIES

605	606	611	612	613	619	622	625	626	626AM	628	629
US3	US4	US9	US10	US10B	US15	US19	US26	US26D	US26DAM	US28	US32
630	630AM	643e	689	691	693	695	706	710	711	721	728
US32D	US32DAM	-	SP28	SP10	SPBLK	SP313	SP4	313	315	US3A	US4A

Pool exit hardware (52)

Designed to meet specific needs of pool enclosures. Weather-resistant components ideal for outdoor applications.

ACN							PRICE BASED ON FINISH					Default trim, included
Device type	Function	Fire	Finish	Device size	Handing	Lever design	626	710				
EXIT HARDWARE							3' DEVICE PRICING SHOWN. 4' ADD \$19 LIST					
[98/99]52	EO	.	[] . [] .				\$2,037	\$1,973				N/A
[98/99]52	L	.	[] . [] . [] . []				\$2,442	\$2,378				252L ¹
[98/99]52	L-BE	.	[] . [] . [] . []				\$2,442	\$2,378				252L-BE ¹

¹ 98/9952 x 252L/LBE template (47273677) can be ordered at no charge if needed before installation.

Compliance specification:

UL Listed for panic exit hardware (UL 305)
ANSI/BHMA A156.3 - 2014, Grade 1
Meets International Building Code for Pool Enclosures
Compliant with 2010 ADA Standards for Accessible Design

DEFAULT ATTRIBUTES

Pricing includes default options shown below. Weep Holes option available. No additional options and configurations available. Consult factory for any questions.

Strike(s):

Exit hardware:

- 98/9952L and 98/9952L-BE devices Include 699 strike
- 98/9952EO devices Include 699 and 299 strikes

ADDITIONAL TRIM AND STRIKE OPTIONS

Trim	628	695
252L	\$471.00	\$471.00
252L-BE	\$471.00	\$471.00

Strike	622	628	695
699	\$123.00	\$123.00	\$123.00

OPTIONS

605	606	611	612	613	619	622	625	626	626AM	628	629
US3	US4	US9	US10	US10B	US15	US19	US26	US26D	US26DAM	US28	US32
630	630AM	643e	689	691	693	695	706	710	711	721	728
US32D	US32DAM	-	SP28	SP10	SPBLK	SP313	SP4	313	315	US3A	US4A

LESS BOTTOM ROD (LBR/LBL Fire-Rated Devices must be ordered in pairs, and one Auxiliary Fire Pin (AFL) is furnished per pair.)	Specify (Suffix)	Price adjustment
98/9927LBR	LBR	-\$124.00
98/9927-F-LBR (First Leaf)	LBR	\$0.00
98/9927-F-LBR-AFL (Second Leaf)	LBR-AFL	\$0.00
98/9947LBR	LBR	-\$133.00
98/9947-F-LBR (First Leaf)	LBR	\$0.00
98/9947-F-LBR-AFL (Second Leaf)	LBR-AFL	\$0.00
98/9947WDC-LBR	LBR	-\$133.00
98/9947WDC-F-LBR (First Leaf)	LBR	\$0.00
98/9947WDC-F-LBR-AFL (Second Leaf)	LBR-AFL	\$0.00

LESS BOTTOM LATCH (LBR/LBL Fire-Rated Devices must be ordered in pairs, and one Auxiliary Fire Pin (AFL) is furnished per pair.)	Specify (Suffix)	Price adjustment
98/9949LBL	LBL	-\$133.00
98/9949-F-LBL (First Leaf)	LBL	-\$133.00
98/9949-F-LBL-AFL (Second Leaf)	LBL-AFL	\$29.00
98/9950WDC-LBL	LBL	-\$133.00
98/9950WDC-F-LBL (First Leaf)	LBL	-\$133.00
98/9950WDC-F-LBL-AFL (Second Leaf)	LBL-AFL	\$29.00

ANTIMICROBIAL COATING - Available in 626 (US26D) and 630 (US32D), use suffix "AM" when ordering. Example: 626AM	Specify (Suffix)	Price adjustment
For device with or without trim	AM	\$73.00
For trim only	AM	\$34.00

CYLINDER DOGGING - Not for use with fire exit hardware	Specify (Prefix)	Price adjustment
Standard baseplate cylinder dogging ³	CD	\$104.00
Chexit cylinder dogging ¹	CD-CXA	\$472.00
Cylinder dogging indicator ²	CI	\$285.00
Dogging indicator ³	DI	\$268.00
Less dogging	LD	\$0.00
Cylinder dogging with indicator	CDSI	\$342.00
Hex dogging with indicator	HDSI	\$246.00
Special center case dogging - panic only ⁴	SD	\$437.00

¹ Available on all 98/99 Chexit panic devices.

² Not available with EL/QEL, Chexit or 2' devices.

³ Available on all 98/99 panic devices. Excludes 2' device.

⁴ Available on 98/99 Rim/27/47/48/49/57/50WDC panic devices only. May be used with EL/QEL option, refer to page 102 for pricing. Specify handing.

OPTIONS

605	606	611	612	613	619	622	625	626	626AM	628	629
US3	US4	US9	US10	US10B	US15	US19	US26	US26D	US26DAM	US28	US32
630	630AM	643e	689	691	693	695	706	710	711	721	728
US32D	US32DAM	-	SP28	SP10	SPBLK	SP313	SP4	313	315	US3A	US4A

DOUBLE CYLINDER	Specify (Suffix)	Price adjustment
98/99 Rim	-2	\$357.00
98/9975 Mortise Device (includes 7500-2 lock) ¹	-2	\$357.00
Double Cylinder with Security Indicator ^{1,2}	-2SI	\$597.00

To order Lock / Unlock label only, please refer to the Double Cylinder table in the 98/99 Parts and Accessories section.

¹ Available with TP, TP-BE, K, K-BE, L and L-BE functions only. Specify handing.

² Available on 98/99 Rim only. Rim cylinder sold separately. Cylinder with T-Turn available from Schlage, order part # XB 11-979.

VON DUPRIN REMOTE UNDOGGING AND REMOTE MONITORING KIT

- Modular retrofit kit for 98/99 and 33A/35A Series devices
- Access control managed via an IP or RSI/ RS-485 connection to the gateway through Allegion software alliance members
- ENGAGE enabled undogging available. See RU/RM data sheet.
- For details regarding the configurations that are available, please see [page 276](#) of the Schlage Electronics Price Book

Consult your access control software provider for pricing and specific scope of support.

SWITCHES - Available on all 98/99 Series devices	Specify (Prefix)	Price adjustment
Request to Exit	RX	\$266.00
Waterproof Request to Exit	WP-RX	\$384.00
Request to Exit Low Current	RX-LC	\$309.00
Request to Exit Double Switch	RX-2	\$331.00
RX to RX-2 Conversion (order part number 050271)	RX-AUX	\$277.00
Latchbolt Monitoring	LX ^{1,2}	\$266.00
Latchbolt Monitoring Low Current	LX-LC ¹	\$309.00
Request to Exit / Latchbolt Monitoring combination	LX-RX ¹	\$402.00
Request to Exit / Latchbolt Monitoring combination Low Current	LX-RX-LC ¹	\$483.00
Signal Switch - for Rim and Vertical Rod Devices, specify handing	SS	\$545.00
Signal Switch - for Mortise Device (includes SS7500 lock), specify handing	SS	\$813.00

¹ For 98/9949, LX switch monitors trim input or electric dogging of EL/QEL devices. LX switch does not monitor latch condition. Not available on 98/9975 mortise device.

² For Latchbolt monitoring on 98/9975 Mortise Devices specify the SS7500 lock and add \$266 list per device.

See page 175-176 for field-installed switch kit part numbers.

LATCH RETRACTION - See 98/99 product catalog for required accessory equipment	Specify (Prefix)	Price adjustment
Electric latch retraction	EL	\$1,015.00
Electric latch retraction with hex dogging (panic only)	HD-EL	\$1,015.00
Electric Latch Retraction with Special Center Case Dogging ¹ (Available with "EL" option)	SD-EL	\$1,416.00
Quiet electric latch retraction	QEL	\$979.00
Quiet electric latch retraction with hex dogging (panic only)	HD-QEL	\$979.00
Quiet Electric Latch Retraction with Special Center Case Dogging ¹ (Available with "QEL" option)	SD-QEL	\$1,416.00
Quiet electric latch retraction for AX devices	QELX	\$1,041.00
Quiet electric latch retraction with hex dogging (panic only) for AX devices	HD-QELX	\$1,041.00
Pneumatic	PN	\$1,514.00

¹ Available only on 98/99 Rim/27/47/48/49/50/57 panic devices. Specify handing.

QUIET MECHANICAL	Specify (Prefix)	Price adjustment
Quiet mechanical: Controls motion to reduce operational noise. The QM device option provides damper-controlled re-latching. Available on 98/99 rim and 98/9927 devices. Compatible with most of the device options including QEL, EL, AX, RX, and CD. Not available with CX and LX. Specify QM996 if quiet trim is desired.	QM	\$199.00

OPTIONS

605	606	611	612	613	619	622	625	626	626AM	628	629
US3	US4	US9	US10	US10B	US15	US19	US26	US26D	US26DAM	US28	US32
630	630AM	643e	689	691	693	695	706	710	711	721	728
US32D	US32DAM	-	SP28	SP10	SPBLK	SP313	SP4	313	315	US3A	US4A

CHEXIT - Available on all 98/99 Series devices	Specify (Prefix)			Price adjustment
	Prefix	Finish	Release delay	
<p>Chexit – Controlled exit device (15 second delay furnished standard)</p> <ul style="list-style-type: none"> DT Function requires an electric strike to access opening Chexit is not available with any electrical options (EL, QEL, PN) Chexit is not available with any switches (RX, RXLC, RX2, WP-RX, LX, LXLC, LXR, LXRXL, SS) For CX98/9927 and CX98/9957 panic and fire devices, two Rod Guards (RGO) supplied standard. Add \$622.00 list per device. For doors over 7' additional RGO's will be added as needed to protect the rods. For each additional RGO, add \$311.00 List. For latch protection, latch guards (LGO) found on page 162 can be ordered separately 	CXA	-	[Release delay]	\$1,940.00
Remote Chexit module	RCM	.[Finish]	.[Release delay]	\$277.00
Chexit 10' cable	CXCAB	-	-	\$124.00

RELEASE DELAY	Specify	Price adjustment
0 Second Delay	0 Delay	\$142.00
30 Second Delay ¹	30 Delay	\$142.00
15 second delay with BOCA Modification ²	BOCA-15 Delay	\$142.00
30 second delay with BOCA Modification ¹ ²	BOCA-30 Delay	\$142.00
2-60 Seconds in 2 Second Intervals or infinite delay ¹ ²	Other Delays	\$190.00

15 second Module sold separately, specify part number 040086.

¹ Over 15 second delay requires a letter of approval from the authority having local jurisdiction over the premises prior to the installation of the device. Allegion cannot grant such approval nor does it warrant local jurisdiction compliance.

² Consult factory for lead time.

EXIT ALARM	Specify	Price adjustment
<p>Exit alarm</p> <ul style="list-style-type: none"> Available on 98/99 Series panic and fire devices Price includes RX switch; can substitute with LX switch at no additional charge For vertical rod tampering monitoring on Surface Vertical Devices, specify device with LX (Latch Bolt Monitor Switch) To order Less Switch, deduct \$266 list 9 volt battery included 	ALK	\$660.00

PULLMAN LATCHES - Not for use with fire exit hardware	Specify	Price adjustment
98/9927 device PL top and PL bottom	PL	\$264.00
98/9947 device PL top and PL bottom	PL	\$372.00
98/9927 device LBR with PL top latch for electric strike application (a panic LBR device is one-point latching not two point, the security of the opening may be compromised)	ES	\$132.00
98/9947 device LBR with PL top latch for electric strike application (a panic LBR device is one-point latching not two point, the security of the opening may be compromised)	ES	\$186.00

ELECTRIC UNLOCKING	Specify (Prefix)	Price adjustment
<ul style="list-style-type: none"> Electric unlocking of outside lever for all 98/9975 mortise devices Available with TP, K, or L functions only "AC" current requires SO12 or SO24 rectifier kit. Add \$45 list per device. Specify FAIL SECURE (FSE) or FAIL SAFE (FS). SO rectifier kit intended for fail secure / momentary use only. Contact product support for assistance. 	E	\$661.00

OPTIONS

605	606	611	612	613	619	622	625	626	626AM	628	629
US3	US4	US9	US10	US10B	US15	US19	US26	US26D	US26DAM	US28	US32
630	630AM	643e	689	691	693	695	706	710	711	721	728
US32D	US32DAM	-	SP28	SP10	SPBLK	SP313	SP4	313	315	US3A	US4A

ELECTRIC UNLOCKING	Specify (Prefix)	Price adjustment
<ul style="list-style-type: none"> Motor driven electric unlocking of outside M996 trim for 98/99 rim, mortise, surface vertical and concealed vertical devices Available with L or LBE functions only, specify handing Dual voltage - works with either 12 or 24 VDC power supplies, furnished Fail Safe (FS) but can be converted in the field with dip switch without mechanical conversion. See page 142 for pricing and optional lever designs 	M996	\$666.00

STORM RATING	Specify (Prefix)	Price adjustment
<p>Hurricane device - devices are listed with Steelcraft doors. Contact factory for specific requirements. List add prices are for the strike price adjustment only. Mullions are priced separately on page 160. Sexbolts required for all device functions will be added to the list price.</p> <p>98/99 rim device x 9954 mullion with 299-F (order mullion as "blank")</p> <p>98/9957 device with 299-F Strike</p> <p>98/9927 device with 299-F Strike</p> <p>98/9975 device with standard strikes</p> <p>98/9947-F device with standard strikes</p> <p>98/9949 device with standard strikes</p> <p>Less trim requires sexbolts</p>	HH	\$16.00
		\$32.00
		\$16.00
		\$0.00
		\$0.00
		\$0.00
		\$84.00
<p>Windstorm device¹ - certified to comply with ICC 500 Standard for the Design and Construction of Storm Shelters, and the Federal Emergency Management Agency's publication FEMA 361 — Design and Construction Guidance for Community Safety. Devices are listed with Steelcraft Paladin doors for tornado listings and Steelcraft "H" Series doors for Hurricane listings.</p> <ul style="list-style-type: none"> Available on the 98/9927² and 98/9957³ Series devices Available with QEL and E996L-BE or M996L-BE trim only Not available with EL option, LNL/NL trim function, and E996L or M996L trim 	WS	\$1,403.00

¹ Miami-Dade Co. / FBC will list compliance to: TAS 201, TAS 202, TAS 203. Design Load Rating: +150/-150 PSF (245 MPH Wind Zone). Enhanced Hurricane Protection (EHPA) ASTM E1996 / ANSI/ICC 500 (245 MPH Wind Zone) / UL - ANSI/ICC 500 certified of F5 - Tornado applications.

² Door applications for WS98/9927 - 8'0" x 8'0" Pairs (swing same direction) 4'0" x 8'0" Single (non-fire rated only) Flush Hollow Metal. UL - FEMA 361 certified.

³ Door applications for WS98/9957 - 4'0" x 8'0" Single (fire and non-fire rated) Flush Hollow Metal. UL-FEMA 361 certified.

ACCESSIBLE DEVICE	Specify (Prefix)	Price adjustment
<ul style="list-style-type: none"> Accessible device compliant with the California Building Code (Section 11B-309.4) requirement for 5 lb. maximum operational force. Available on AX98/99, AX98/99-F Rim, AX98/9949 LBL, LBL-AFL, AX98/9927-LBR, AX98/9927-LBR-F, 98/9950WDC-LBL and 98/9950WDC-LBL-F Trim functions available EO, DT, NL, L, LBE, LDT and LNL EL and QELX options available Not available with CX 	AX	\$67.00

TOUCHBAR OPTIONS	Specify		Price adjustment
	Suffix	Handing	
Vision impaired touchpad, raised letters and braille, 630 finish. Standard reads "Caution Stairwell." Optional up to 20 alpha / numeric characters on single line, consult factory.	BRAILLE	.[RHR, LHR]	\$134.00
Brass, bronze and stainless touchbar trims embossed "PUSH". No additional charge when specified with device.	EMB	.[RHR, LHR]	\$0.00
Red silk-screened lettered touchbar trims (standard on SS devices). "Emergency Exit Only, Push to Open and Sound Alarm" No additional charge when specified with device.	RSS	.[RHR, LHR]	\$0.00
Knurled touchpad. No additional charge when specified with device.	KN	-	\$0.00
Safety glow feature for 3' device	SG	-	\$488.00

OPTIONS

605	606	611	612	613	619	622	625	626	626AM	628	629
US3	US4	US9	US10	US10B	US15	US19	US26	US26D	US26DAM	US28	US32
630	630AM	643e	689	691	693	695	706	710	711	721	728
US32D	US32DAM	-	SP28	SP10	SPBLK	SP313	SP4	313	315	US3A	US4A

TOUCHBAR OPTIONS	Specify		Price adjustment
	Suffix	Handing	
Safety glow feature for 4' device	SG	-	\$508.00

Custom graphics available on touchbar trim. See page 7 for details.

WEEP HOLES	Specify	Price adjustment
Drainage (weep) holes in mechanism case. 3' device will have 4 holes - 6" spacing, 4' device will have 6 holes	WH	\$96.00

CONNECTORS	Specify	Price adjustment
Cross-category solution using interconnect components for electrified options. Available with ALK, LX, LXLC, LXR, LXRXL, RX and RXLC switches, EL, QEL, CX, E996, M996, E7500, SS7500	CON	\$0.00

NON-STANDARD DOOR THICKNESS	Specify	Price adjustment
Door thickness > 2-1/4" - <= 4 1/4"		
98/99 Rim, 98/9947/47WDC, 98/9948, 98/9949, 98/9950WDC with EO (exit only no trim), with sex bolts	.DT[]	\$96.00
98/99 Rim, 98/9947/47WDC, 98/9948, 98/9949, 98/9950WDC with NL-OP (with 110NL cylinder control), with sex bolts	.DT[]	\$192.00
98/99 Rim, 98/9947/47WDC, 98/9948, 98/9949, 98/9950WDC with NL-OP (with 110NL cylinder control), no sex bolts	.DT[]	\$96.00
98/9927, 98/9957 devices EO (exit only no trim), with or without sex bolts	.DT[]	\$96.00
98/9927, 98/9957 devices NL-OP (with 110NL cylinder control), with or without sex bolts.	.DT[]	\$192.00

For devices with other trim, add \$92.00 and see page 16 for trim list adders.

INSULCLAD OR APPLIED PANEL - Not available for fire door applications	Specify	Price adjustment/ price each
1/2" Panel - for 98/9947 devices ¹	INS-2	\$72.00
1/4" Panel - for 98/9947 devices	INS-4	\$72.00
1/2" Panel - for 98/9949 devices	INS-2	\$72.00
1/4" Panel - for 98/9949 devices	INS-4	\$72.00

¹ Available only with 996L-NL/L-DT/K-NL/K-DT/EO, 110NL-OP, 990EO trims, and EO devices.

KITS

605	606	611	612	613	619	622	625	626	626AM	628	629
US3	US4	US9	US10	US10B	US15	US19	US26	US26D	US26DAM	US28	US32
630	630AM	643e	689	691	693	695	706	710	711	721	728
US32D	US32DAM	-	SP28	SP10	SPBLK	SP313	SP4	313	315	US3A	US4A

QUIET MECHANICAL RETROFIT KITS	Specify	Price each
QM Rim Device Retrofit Kit - 98/99 Rim	47259560	\$199.00
QM SVR Device Retrofit Kit - 98/9927A	47263418	\$199.00

EL CONVERSION KITS - Field conversion kits for Electric Latch Retraction	Specify				Price each
	Standard		Allegion Connect -CON		
	3' device	4' device	3' device	4' device	
EL baseplate conversion kit	050070	050078	050853	050854	\$1,184.00
HD-EL baseplate conversion kit (hex dogging included, panic only)	050384	050385	050855	050856	\$1,184.00

QEL CONVERSION KITS - Field conversion kits for Quiet Electric Latch Retraction	Specify				Price each
	Standard		Allegion Connect -CON		
	3' device	4' device	3' device	4' device	
Baseplate conversion kits (may be used for ANY conversion application)					
QEL baseplate conversion kit	958003	040065	040063	040066	\$1,029.00
HD-QEL baseplate conversion kit (hex dogging included, panic only)	958004	040067	040064	040068	\$1,029.00
QELX baseplate conversion kit for AX devices	041166	041167	041168	041169	\$1,091.00
HD-QELX Baseplate Conversion Kit for AX devices (hex dogging included, panic only)	041170	041171	041172	041173	\$1,091.00
Modular conversion kits (for non-EL panic devices, for non-EL fire-rated devices sold after October 2014, or for replacing existing motor)					
QEL modular conversion kit	114317	114317	040061	040061	\$979.00
HD-QEL modular conversion kit (hex dogging included, panic only)	958002	958002	040062	040062	\$979.00
QELX modular conversion kit for AX devices	041162	041162	041163	041163	\$1,041.00
HD-QELX modular conversion kit for AX devices (hex dogging Included, panic only)	041164	041164	041165	041165	\$1,041.00

ESL (EMERGENCY SECURE LOCKDOWN) KITS	Specify			Price each
	3' device	4' device	Finish	
98 ESL Kit - Retrofit kit for QEL 98 devices; Panic or Fire (not available in 619 or 630)	967244	967245	.[Finish]	\$425.00
99 ESL Kit - Retrofit kit for QEL 99, devices; Panic or Fire	967246	967247	.[Finish]	\$425.00

- No WS
- No mechanical dogging of QEL (SD-QEL, HD-QEL)
- Unit requires a standard 1 1/4" (32mm) mortise cylinder with an inverted straight cam and compression ring and spring. Kit does not come with cylinder or thumbturn, must be ordered separately. Examples: Schlage conventional cylinder: 20-001 1 1/4" XQ11-949; Schlage thumbturn cylinder: 09-904 1 1/4" B502-191 XQ11-949; Schlage ADA thumbturn cylinder: 09-904 1 1/4" XB11-720 B502-191 XQ11-949
- Install in alignment with 2018 IBC 1010.2.8 NFPA 101 14.2.2.2.4 or per local AHJ - Only allowed with trim functions: NL, K-NL, L-NL, NL-OP, T-NL

CX OPTIONS	Specify		Price each
	Part number	Finish	
RCM KIT-98 Less Module	040199	.[Finish]	\$278.00
RCM KIT-99 Less Module	040198	.[Finish]	\$278.00

KITS

605	606	611	612	613	619	622	625	626	626AM	628	629
US3	US4	US9	US10	US10B	US15	US19	US26	US26D	US26DAM	US28	US32
630	630AM	643e	689	691	693	695	706	710	711	721	728
US32D	US32DAM	-	SP28	SP10	SPBLK	SP313	SP4	313	315	US3A	US4A

ELECTRICAL UNLOCKING RETROFIT KITS	Specify	Price each
996 R/V/C Conversion to M996 Motorized Kit	47273111	\$740.00
996 Mort Conversion to M996 Motorized Kit	47273112	\$770.00

LBR/LBL RETROFIT KITS FOR FIRE-RATED DEVICES	Specify	Price each
98/9927-F LBR Kit - Auxiliary fire pin and two required 499F strikes	050171-32	\$492.00
98/9947-F/47WDC-F/49-F LBR/LBL Kit - Auxiliary fire pin only	051860-32	\$162.00
98/9950WDC-F LBL Kit - Auxiliary fire pin, auxiliary fire latch strike, sleeve and screws	48968887	\$174.00

49 CABLE SYSTEM Device type and door opening height must be specified when ordering	Specify			Price each
	Device type	Part number	Door height Specify height between 6'0" - 10'0"	
Complete cable system Includes: Top and bottom strikes, latches, centerslides, cables and mounting packs	[]	CS	[]	\$1,036.00
Cable system, less bottom latch Includes: Top strike, top latch, top cable, centerslides and mounting packs	[]	CS-LBL	[]	\$903.00
Cable system, less bottom latch with fire pin kit Includes: Top strike, top latch, top cable, centerslides, mounting packs and fire pin kit	[]	CS-LBL-49AFL	[]	\$1,065.00

For door opening heights less than 6'10" and more than 10', consult factory.
Consult customer support for non-standard center lines or if a threshold is installed.

50 WDC CABLE SYSTEM Device type and door opening height must be specified when ordering	Specify			Price each
	Device type	Part number	Door height Specify height between 6'0" - 10'0"	
Complete cable system Includes: Top and bottom latches, strikes, cables, centerslide and mounting packs	[]	CS	[]	\$1,186.00
Fire-rated complete cable system Includes: Top and bottom latches, strikes, cables, centerslide, mounting packs, fire kit	[]	CS-F	[]	\$1,498.00
Cable system - Less bottom latch Includes: Top latch, strike, cable, centerslide and mounting packs	[]	CS-LBL	[]	\$1,052.00
Fire-rated cable system - Less bottom latch Includes: Top latch, strike, cable, centerslide, mounting packs, fire kit, fire pin kit	[]	CS-LBL-F	[]	\$1,525.00

INSULCLAD OR APPLIED PANEL KITS - Not available for fire door applications	Specify	Price each
1/2" Panel Kit - for 98/9947 devices ¹	051841-00	\$280.00
1/4" Panel Kit - for 98/9947 devices	051842-00	\$170.00
1/2" Panel Kit - for 98/9949 devices	24122285	\$72.00
1/4" Panel Kit - for 98/9949 devices	24122327	\$72.00

¹ Available only with 996L-NL/L-DT/K-NL/K-DT/EO, 110NL-OP, 990EO trims, and EO devices.

PARTS AND ACCESSORIES

605	606	611	612	613	619	622	625	626	626AM	628	629
US3	US4	US9	US10	US10B	US15	US19	US26	US26D	US26DAM	US28	US32
630	630AM	643e	689	691	693	695	706	710	711	721	728
US32D	US32DAM	-	SP28	SPIO	SPBLK	SP313	SP4	313	315	US3A	US4A

CENTER CASE										
Description	Specify		Non-Finished	628, 710, 711	626	✓ 630	612	606	605, ✓ 619, 625, 643e	
	Part number	Finish								
98/99 Rim Center Case Kit Less Cover	050020	-	\$484.00	-	-	-	-	-	-	
98/99-F Rim Center Case Kit Less Cover	050026	-	\$506.00	-	-	-	-	-	-	
98/9927/-F Center Case Kit Less Cover	050021	-	\$261.00	-	-	-	-	-	-	
98/9947/48/-F Center Case Kit Less Cover	050022	-	\$670.00	-	-	-	-	-	-	
98/9975/-F Center Case Kit Less Cover	050023	-	\$187.00	-	-	-	-	-	-	
98/99-2 RHR Center Case Kit Less Cover	050024	-	\$831.00	-	-	-	-	-	-	
98/99-2 LHR Center Case Kit Less Cover	050025	-	\$831.00	-	-	-	-	-	-	
98/99-F-2 RHR Center Case Kit Less Cover	050027	-	\$842.00	-	-	-	-	-	-	
98/99-F-2 LHR Center Case Kit Less Cover	050028	-	\$842.00	-	-	-	-	-	-	
98/9975-2 RHR Center Case Kit Less Cover	050029	-	\$323.00	-	-	-	-	-	-	
98/9975-2 LHR Center Case Kit Less Cover	050030	-	\$323.00	-	-	-	-	-	-	
SD98/99/57 RHR Rim Center Case Kit Less Cover	050548	-	\$809.00	-	-	-	-	-	-	
SD98/99/57 LHR Rim Center Case Kit Less Cover	050549	-	\$809.00	-	-	-	-	-	-	
SD98/9927 RHR Center Case Kit Less Cover	050550	-	\$595.00	-	-	-	-	-	-	
SD98/9927 LHR Center Case Kit Less Cover	050551	-	\$595.00	-	-	-	-	-	-	
SD98/9947/48/49 RHR Center Case Kit Less Cover	050552	-	\$831.00	-	-	-	-	-	-	
SD98/9947/48/49 LHR Center Case Kit Less Cover	050553	-	\$831.00	-	-	-	-	-	-	
WS98/9927 Center Case RHR Less Cover	101024	-	\$484.00	-	-	-	-	-	-	
WS98/9927 Center Case LHR Less Cover	101023	-	\$484.00	-	-	-	-	-	-	
WS98/9957 Center Case RHR Less Cover	24086894	-	\$484.00	-	-	-	-	-	-	
WS98/9957 Center Case LHR Less Cover	24086860	-	\$484.00	-	-	-	-	-	-	
SD98/99 Rim Conversion Kit RHR	050386	[Finish]	-	\$1,168.00	\$1,228.00	\$1,277.00	\$1,277.00	\$1,228.00	\$1,289.00	
SD98/99 Rim Conversion Kit LHR	050387	[Finish]	-	\$1,168.00	\$1,228.00	\$1,277.00	\$1,277.00	\$1,228.00	\$1,289.00	
98/99-2 Conversion Kit RHR	050388	[Finish]	-	\$1,168.00	\$1,228.00	\$1,277.00	\$1,277.00	\$1,228.00	\$1,289.00	
98/99-2 Conversion Kit LHR	050389	[Finish]	-	\$1,168.00	\$1,228.00	\$1,277.00	\$1,277.00	\$1,228.00	\$1,289.00	
98/99-F-2 Conversion Kit RHR	050886	[Finish]	-	\$1,367.00	\$1,429.00	\$1,488.00	\$1,476.00	\$1,429.00	\$1,488.00	
98/99-F-2 Conversion Kit LHR	050885	[Finish]	-	\$1,367.00	\$1,429.00	\$1,488.00	\$1,476.00	\$1,429.00	\$1,488.00	
98/99-2SI Conversion Kit RHR	051883	[Finish]	-	\$1,434.00	\$1,498.00	\$1,542.00	\$1,542.00	\$1,542.00	\$1,557.00	
98/99-2SI Conversion Kit LHR	051884	[Finish]	-	\$1,434.00	\$1,498.00	\$1,542.00	\$1,542.00	\$1,542.00	\$1,557.00	
98/99-F-2SI Conversion Kit RHR	050884	[Finish]	-	\$1,634.00	\$1,697.00	\$1,742.00	\$1,742.00	\$1,697.00	\$1,757.00	
98/99-F-2SI Conversion Kit LHR	050883	[Finish]	-	\$1,634.00	\$1,697.00	\$1,742.00	\$1,742.00	\$1,697.00	\$1,757.00	
98/99-2SI Center Case Cover Kit RHR	050831	[Finish]	-	\$204.00	\$236.00	\$265.00	\$236.00	\$236.00	\$282.00	
98/99-2SI Center Case Cover Kit LHR	050832	[Finish]	-	\$204.00	\$236.00	\$265.00	\$236.00	\$236.00	\$282.00	
98/99/-F Center Case Cover Kit	050071	[Finish]	-	\$152.00	\$219.00	\$229.00	\$219.00	\$219.00	\$252.00	
98/9927/27-F Center Case Cover Kit	050072	[Finish]	-	\$152.00	\$219.00	\$229.00	\$219.00	\$219.00	\$252.00	
98/9947/47/49/75/75-F Center Case Cover Kit	050073	[Finish]	-	\$152.00	\$219.00	\$229.00	\$219.00	\$219.00	\$252.00	
98/9957/-F Center Case Cover Kit	050554	[Finish]	-	\$152.00	\$219.00	\$229.00	\$219.00	\$219.00	\$252.00	
98/99-2/SD RHR Center Case Cover Kit	050555	[Finish]	-	\$198.00	\$229.00	\$257.00	\$229.00	\$229.00	\$275.00	
98/99-2/SD LHR Center Case Cover Kit	050556	[Finish]	-	\$198.00	\$229.00	\$257.00	\$229.00	\$229.00	\$275.00	
98/9975-2 RHR Center Case Cover Kit	050557	[Finish]	-	\$198.00	\$229.00	\$257.00	\$229.00	\$229.00	\$275.00	

For Antimicrobial Finishes add \$10.00 to list. ✓ 630 AND 619 finishes available with Series 98 only.

PARTS AND ACCESSORIES

605	606	611	612	613	619	622	625	626	626AM	628	629
US3	US4	US9	US10	US10B	US15	US19	US26	US26D	US26DAM	US28	US32
630	630AM	643e	689	691	693	695	706	710	711	721	728
US32D	US32DAM	-	SP28	SP10	SPBLK	SP313	SP4	313	315	US3A	US4A

CENTER CASE									
Description	Specify		Non-Finished	628, 710, 711	626	✓630	612	606	605, ✓619, 625, 643e
	Part number	Finish							
98/9975-2 LHR Center Case Cover Kit	050558	.[Finish]	-	\$198.00	\$229.00	\$257.00	\$229.00	\$229.00	\$275.00
CX-CD/SD98/9927 RHR Center Case Cover Kit	050559	.[Finish]	-	\$198.00	\$229.00	\$257.00	\$229.00	\$229.00	\$275.00
CX-CD/SD98/9927 LHR Center Case Cover Kit	050560	.[Finish]	-	\$198.00	\$229.00	\$257.00	\$229.00	\$229.00	\$275.00
CX-CD/SD98/9947 RHR Center Case Cover Kit	050562	.[Finish]	-	\$198.00	\$229.00	\$257.00	\$229.00	\$229.00	\$275.00
CX-CD/SD98/9947 LHR Center Case Cover Kit	050563	.[Finish]	-	\$198.00	\$229.00	\$257.00	\$229.00	\$229.00	\$275.00
Control Link Pin Kit	050529	-	\$14.00	-	-	-	-	-	-
Retaining Ring Pkg/10	090107	-	\$14.00	-	-	-	-	-	-
Control Link Pin Pkg/10	090031	-	\$17.00	-	-	-	-	-	-
NL Drive Screw Pkg/10	090074	-	\$22.00	-	-	-	-	-	-
Latchbolt Pin Pkg/10	090079	-	\$14.00	-	-	-	-	-	-
Center Case Cover Bracket	050564	-	\$17.00	-	-	-	-	-	-
Center Case Reinforcing Bracket	050565	-	\$17.00	-	-	-	-	-	-
CD-CX/SD Cylinder Dog Housing	112409	.[Finish]	-	\$155.00	\$155.00	-	\$155.00	\$155.00	\$155.00
CX-CD/SD Cylinder Dog Bracket Kit LHR	112456	-	\$84.00	-	-	-	-	-	-
CX-CD/SD Cylinder Dog Bracket Kit RHR	112455	-	\$84.00	-	-	-	-	-	-
98/99-2 Rim Cylinder Adaptor	114984	.[Finish]	-	\$146.00	\$146.00	\$146.00	\$146.00	\$146.00	\$146.00
98/9975-2 LHR Cylinder Adaptor	113100	.[Finish]	-	\$230.00	\$230.00	\$230.00	\$230.00	\$230.00	\$230.00
98/9975-2 RHR Cylinder Adaptor	113101	.[Finish]	-	\$230.00	\$230.00	\$230.00	\$230.00	\$230.00	\$230.00
Center Case Cover Screws	900892	.[Finish]	-	\$14.00	-	\$14.00	\$14.00	\$14.00	\$14.00
Center Case Cover Bearing Insert-Bracket	969889	-	\$14.00	-	-	-	-	-	-

For Antimicrobial Finishes add \$10.00 to list. ✓ 630 AND 619 finishes available with Series 98 only.

COVER PLATE / CONVERSION KITS									
Description	Specify		Non-Finished	628, 710, 711	626	✓630	612	606	605, ✓619, 625, 643e
	Part number	Finish							
99 Hex Dog Conversion Kit fits 3' to 4'	050114	.[Finish]	-	\$78.00	-	-	\$78.00	\$78.00	\$78.00
98 Hex Dog Conversion Kit fits 3' to 4'	050117	.[Finish]	-	\$78.00	-	\$78.00	\$78.00	\$78.00	\$78.00
99 CD Conversion Kit fits 3' to 4'	050115	.[Finish]	-	\$104.00	-	-	\$104.00	\$104.00	\$104.00
98 CD Conversion Kit fits 3' to 4'	050132	.[Finish]	-	\$104.00	-	\$104.00	\$104.00	\$104.00	\$104.00
98 CDSI Kit 3' / 4'	040078/040079	.[Finish]	-	\$342.00	\$342.00	\$342.00	\$342.00	\$342.00	\$342.00
98 HDSI Kit 3' / 4'	040080/040081	.[Finish]	-	\$246.00	\$246.00	\$246.00	\$246.00	\$246.00	\$246.00
99 CDSI Kit 3' / 4'	040082/040083	.[Finish]	-	\$342.00	\$342.00	-	\$342.00	\$342.00	\$342.00
99 HDSI Kit 3' / 4'	040084/040085	.[Finish]	-	\$246.00	\$246.00	-	\$246.00	\$246.00	\$246.00
CDSI/HDSI Configuration Pkg	900416	-	\$18.00	-	-	-	-	-	-
99 Fire or Less Dogging Cover Plate Kit fits 3' to 4'	050589	.[Finish]	-	\$48.00	-	-	\$48.00	\$48.00	\$48.00
98 Fire or Less Dogging Cover Plate Kit fits 3' to 4'	050588	.[Finish]	-	\$48.00	-	\$48.00	\$48.00	\$48.00	\$48.00
99 ALK Cover Plate Kit fits 3' to 4'	050569	.[Finish]	-	\$114.00	-	-	\$114.00	\$114.00	\$114.00
98 ALK Cover Plate Kit fits 3' to 4'	050570	.[Finish]	-	\$114.00	-	\$114.00	\$114.00	\$114.00	\$114.00

For Antimicrobial Finishes add \$10.00 to list. ✓ 630 AND 619 finishes available with Series 98 only.

Z2 SERIES
 33A/35A SERIES
 55 SERIES
 88 SERIES
 98/99 SERIES
 XP98/XP99 SERIES
 94/95 SERIES
 GUARD-X SERIES
 ACCESSORIES / PARTS
 ELECTRICAL / PARTS

PARTS AND ACCESSORIES

605	606	611	612	613	619	622	625	626	626AM	628	629
US3	US4	US9	US10	US10B	US15	US19	US26	US26D	US26DAM	US28	US32
630	630AM	643e	689	691	693	695	706	710	711	721	728
US32D	US32DAM	-	SP28	SP10	SPBLK	SP313	SP4	313	315	US3A	US4A

COVER PLATE / CONVERSION KITS

Description	Specify		Non-Finished	628, 710, 711	626	✓630	612	606	605, ✓619, 625, 643e
	Part number	Finish							
CX99 Cover Plate Kit fits 3' to 4'	040093	.[Finish]	-	\$114.00	-	-	\$114.00	\$114.00	\$114.00
CX98 Cover Plate Kit fits 3' to 4'	040094	.[Finish]	-	\$114.00	-	\$114.00	\$114.00	\$114.00	\$114.00
99 CI Kit 3'	050770	.[Finish]	-	\$291.00	-	-	\$291.00	\$291.00	\$291.00
98 CI Kit 3'	050771	.[Finish]	-	\$291.00	-	\$291.00	\$291.00	\$291.00	\$291.00
99 CI Kit 4'	050772	.[Finish]	-	\$291.00	-	-	\$291.00	\$291.00	\$291.00
98 CI Kit 4'	050773	.[Finish]	-	\$291.00	-	\$291.00	\$291.00	\$291.00	\$291.00
99 DI Kit 3'	050766	.[Finish]	-	\$268.00	-	-	\$268.00	\$268.00	\$268.00
98 DI Kit 3'	050767	.[Finish]	-	\$268.00	-	\$268.00	\$268.00	\$268.00	\$268.00
99 DI Kit 4'	050768	.[Finish]	-	\$268.00	-	-	\$268.00	\$268.00	\$268.00
98 DI Kit 4'	050769	.[Finish]	-	\$268.00	-	\$268.00	\$268.00	\$268.00	\$268.00
98/9947WDC Conversion Kit - Panic Only	050134	.[Finish]	-	\$371.00	-	\$300.00	\$306.00	\$340.00	\$408.00

For Antimicrobial Finishes add \$10.00 to list. ✓ 630 AND 619 finishes available with Series 98 only.

END CAP

Description	Specify		Non-Finished	628, 710	626	✓630	612	606	605, ✓619, 625, 711, 643e
	Part number	Finish							
98/99 Impact Resistant End Cap Kit	050014	.[Finish]	-	\$86.00	\$96.00	\$107.00	\$107.00	\$97.00	\$97.00
98/99 Impact Resistant End Cap Scr Pkg	900597	.[Finish]	-	\$14.00	\$14.00	\$14.00	\$17.00	\$14.00	\$14.00
98/99 Impact Resistant End Cap Bracket	050524	-	\$12.00	-	-	-	-	-	-

PUSH BAR

Description	Specify		Non-Finished	628, 710	626	✓630	612	606	605, ✓619, 625, 711, 643e
	Part number	Finish							
98/99 Push Bar Retrofit Kit - 3' Dr*	See Note	.[Finish]	-	\$223.00	\$263.00	\$400.00	\$360.00	\$348.00	\$412.00
98/99 Push Bar Retrofit Kit - 4' Dr*	See Note	.[Finish]	-	\$240.00	\$289.00	\$417.00	\$376.00	\$360.00	-
98/99 Push Bar Guide Pkg/10	090049	-	\$15.00	-	-	-	-	-	-

* To order, specify device type, size, finish. Example: PBKIT 99 3' 628

MECHANISM CASE

Description	Specify		Non-Finished	695, 711, 628	626	✓630	612	606	605, ✓619, 625
	Part number	Finish							
99 Series Mechanism Case - 3' Door	968144	.[Finish]	-	\$155.00	-	-	\$193.00	\$193.00	\$220.00
99 Series Mechanism Case - 4' Door	968146	.[Finish]	-	\$220.00	-	-	\$254.00	\$254.00	\$287.00

For Antimicrobial Finishes add \$10.00 to list. ✓ 630 AND 619 finishes available with Series 98 only.

PARTS AND ACCESSORIES

605	606	611	612	613	619	622	625	626	626AM	628	629
US3	US4	US9	US10	US10B	US15	US19	US26	US26D	US26DAM	US28	US32
630	630AM	643e	689	691	693	695	706	710	711	721	728
US32D	US32DAM	-	SP28	SP10	SPBLK	SP313	SP4	313	315	US3A	US4A

MECHANISM CASE

Description	Specify		Non-Finished	695, 711, 628	626	✓630	612	606	605, ✓619, 625
	Part number	Finish							
98 Series Mechanism Case - 3' Door	970191	.[Finish]	-	\$155.00	-	\$202.00	\$193.00	\$193.00	\$220.00
98 Series Mechanism Case - 4' Door	970192	.[Finish]	-	\$220.00	-	\$270.00	\$254.00	\$254.00	\$287.00
CD/SS Cylinder Mtg Kit	107813	.[Finish]	-	\$68.00	\$64.00	-	\$68.00	\$68.00	\$74.00
CD/SS Cylinder Locating Washer Pkg	050490	-	\$17.00	-	-	-	-	-	-
CD/SS Mortise Cylinder Collar Pkg	050525	.[Finish]	-	\$48.00	\$48.00	-	\$58.00	\$48.00	\$58.00
CD/SS Cylinder Lock Nut Pkg	050526	-	\$15.00	-	-	-	-	-	-
CD Actuator Pkg/2	090045	-	\$14.00	-	-	-	-	-	-
CD Dogging Plug Pkg/2	090046	-	\$13.00	-	-	-	-	-	-
227 Dog Key 5/32" Pkg/10	090085	-	\$76.00	-	-	-	-	-	-
Mechanism Case Brkt Screw Pkg/10	090073	-	\$12.00	-	-	-	-	-	-
98/99 Rim/75 98/9927-F Mtg. Pkg. 1 3/4"-2 1/4" Dr	900561	-	\$14.00	-	-	-	-	-	-
98/99 Rim, 98/9927-F Mtg. Pkg. >2 1/4"-2 3/4" Dr	900424	-	\$95.00	-	-	-	-	-	-
98/99 Rim, 98/9927-F Mtg. Pkg. >2 3/4"-3 1/4" Dr	900425	-	\$95.00	-	-	-	-	-	-
98/99 Rim, 98/9927-F Mtg. Pkg. >3 1/4"-3 3/4" Dr	900426	-	\$95.00	-	-	-	-	-	-
98/99 Rim, 98/9927-F Mtg. Pkg. >3 3/4"-4 1/4" Dr	900427	-	\$95.00	-	-	-	-	-	-
98/9927/27-F Mtg. Pkg. 2 1/4" Door	900568	-	\$14.00	-	-	-	-	-	-

For Antimicrobial Finishes add \$10.00 to list. ✓ 630 AND 619 finishes available with Series 98 only.

BASEPLATE

Description	Specify		Non-Finished	628, 710 612, 606 605, 625, 643e
	Part number	Finish		
Shock Absorber Pkg	050491	-	\$33.00	-
Baseplate Screw Pkg/10	090037	-	\$13.00	-
Baseplate Bumper Pkg/4	090038	-	\$13.00	-
Baseplate Return Spring Pkg/10	090039	-	\$14.00	-
Hex Dogging Shaft Pkg/2	090040	-	\$14.00	-
Dogging Spring Pkg/2	090041	-	\$13.00	-
Dogging Adaptor Spring Pkg/2	090042	-	\$17.00	-
Dogging Adaptor Pkg/2	090043	-	\$14.00	-
Dogging Hook Pkg/2	090044	-	\$14.00	-
Baseplate Bearing Strip Pkg/2	090048	-	\$14.00	-
227 Dog Key 5/32" Pkg/2	090005	-	\$22.00	-
227 Dog Key 5/32" Pkg/10	090085	-	\$76.00	-
98/9927-F LBR Latch Spring Pkg/10	090088	-	\$23.00	-
CD-CX/SD98/99Rim/27/57 Dogging Hook Screw Pkg/10	47361518	-	\$18.00	-
CD-CX/SD98/9947/48/49/50 Dogging Hook Screw Pkg/10	47361514	-	\$11.00	-
EL Dogging Rod Kit - 3'	050531	-	\$67.00	-

22 SERIES
 33A/35A SERIES
 55 SERIES
 88 SERIES
 98/99 SERIES
 XP98/XP99 SERIES
 94/95 SERIES
 GUARD-X SERIES
 ACCESSORIES / PARTS
 ELECTRICAL / PARTS

PARTS AND ACCESSORIES

605	606	611	612	613	619	622	625	626	626AM	628	629
US3	US4	US9	US10	US10B	US15	US19	US26	US26D	US26DAM	US28	US32
630	630AM	643e	689	691	693	695	706	710	711	721	728
US32D	US32DAM	-	SP28	SP10	SPBLK	SP313	SP4	313	315	US3A	US4A

BASEPLATE				
Description	Specify		Non-Finished	628, 710 612, 606 605, 625, 643e
	Part number	Finish		
EL Dogging Rod Kit - 4'	050532	-	\$67.00	-
QEL/MEL Motor Cable with 6' Harness	47269206	-	\$62.00	-
EL Potted Circuit Breaker	050534	-	\$327.00	-
EL Solenoid/Plunger	050535	-	\$371.00	-
HD-EL Solenoid	050536	-	\$371.00	-
HD-EL Solenoid Plunger	050537	-	\$136.00	-
EL Dogging Rod Retainer	050538	-	\$15.00	-
EL Receptacle Connector	050539	-	\$14.00	-
EL Female Terminal	050540	-	\$14.00	-
HD-EL Dog Screw	050541	-	\$17.00	-
HD-EL Solenoid Bracket	050542	-	\$30.00	-
HD-EL Dogging Spring	050543	-	\$17.00	-
SS Cable	050544	-	\$146.00	-
SS Housing	050545	-	\$487.00	-
CX99-RCM Kit Less Module	040198	.[Finish]	-	\$278.00
CX98-RCM Kit Less Module	040199	.[Finish]	-	\$278.00
Chexit Wiring Assembly	040191	-	\$211.00	-
Sign 15 Second - Chexit/DE5300	113781	-	\$62.00	-
Sign 30 Second - Chexit/DE5300	113782	-	\$67.00	-

VERTICAL LATCHES									
Description	Specify		Non-Finished	628	626	629, ✓630	710, 711	606, 612	605, ✓619, 625, 643e
	Part number	Finish							
98/9927/98/9957 Top Latch Retrofit Kit W/SNB*	050091	.[Finish]	-	\$155.00	\$155.00	\$155.00	\$155.00	\$155.00	\$155.00
98/9927/98/9957 Bottom Latch Retrofit Kit W/SNB*	050090	.[Finish]	-	\$155.00	\$155.00	\$155.00	\$155.00	\$155.00	\$155.00
98/9927/98/9957 Top Latch Kit Less Cover	050400	-	\$155.00	-	-	-	-	-	-
98/9927/98/9957 Bottom Latch Kit Less Cover	050401	-	\$155.00	-	-	-	-	-	-
98/9927/98/9957 Pullman Latch Kit Less Cover	050402	-	\$155.00	-	-	-	-	-	-
98/9947 Top Latch Kit	050492	-	\$302.00	-	-	-	-	-	-
98/9947 Bottom Latch Kit	050493	-	\$245.00	-	-	-	-	-	-
ES98/9947 Top Latch Kit	050128	-	\$220.00	-	-	-	-	-	-
98/9948 Top Latch Kit - (non EL)**	050494	-	\$441.00	-	-	-	-	-	-
EL98/9948 Top Latch Kit**	050516	-	\$417.00	-	-	-	-	-	-
98/9948 Bottom Latch Kit**	050495	-	\$474.00	-	-	-	-	-	-
98/9948 Latch Retrofit Kit - (non EL)	050047	-	\$739.00	-	-	-	-	-	-
98/9948-F Latch Retrofit Kit - (non EL)	050048	-	\$739.00	-	-	-	-	-	-

* For Devices shipped before October, 1998

**For service replacement only. Refer to Retrofit Kits 050047, 050048, 050522 and 050523 to convert 98/9947 Device to 98/9948.

✓ 630 AND 619 finishes available with Series 98 only.

PARTS AND ACCESSORIES

605	606	611	612	613	619	622	625	626	626AM	628	629
US3	US4	US9	US10	US10B	US15	US19	US26	US26D	US26DAM	US28	US32
630	630AM	643e	689	691	693	695	706	710	711	721	728
US32D	US32DAM	-	SP28	SP10	SPBLK	SP313	SP4	313	315	US3A	US4A

VERTICAL LATCHES

Description	Specify		Non-Finished	628	626	629, ✓630	710, 711	606, 612	605, ✓619, 625, 643e
	Part number	Finish							
EL98/9948 Latch Retrofit Kit	050522	-	\$739.00	-	-	-	-	-	-
EL98/9948-F Latch Retrofit Kit	050523	-	\$739.00	-	-	-	-	-	-
98/9927/98/9957/27-F Latch Case Cover Kit	050566	.[Finish]	-	\$58.00	\$74.00	\$85.00	\$58.00	\$68.00	\$78.00
98/9927/98/9957/27-F Latch Cover Screw Pkg.	900850	.[Finish]	-	-	\$14.00	\$14.00	\$14.00	\$14.00	\$14.00
98/9927/98/9957 Top Latch Compression Spring Pkg/10	090056	-	\$14.00	-	-	-	-	-	-
98/9927/98/9957 Top Latch Spring Pkg/10	090057	-	\$14.00	-	-	-	-	-	-
98/9927/98/9957 Bolt Return Spring Pkg/10	090065	-	\$14.00	-	-	-	-	-	-
98/9927/98/9957 Top Latch Aux. Bolt Spring Pkg/10	090076	-	\$14.00	-	-	-	-	-	-
LBR Fire Latch/Strike Kit	050171	-	\$492.00	-	-	-	-	-	-
98/9927/98/9957-F AFL Strike Hole Plug	050509	-	\$12.00	-	-	-	-	-	-
98/9927/98/9957 Latch Mtg Bracket Kit	050546	-	\$31.00	-	-	-	-	-	-
98/9927/98/9957 Std 1-3/4"-2-1/4" Latch Mtg Pkg/4	900589	-	\$14.00	-	-	-	-	-	-
98/9927/98/9957 Latch Mtg. Pkg/2 for >2-1/4" - 2-3/4" Dr	900521	-	\$95.00	-	-	-	-	-	-
98/9927/98/9957 Latch Mtg. Pkg/2 for >2-3/4" - 3-1/4" Dr	900522	-	\$95.00	-	-	-	-	-	-
98/9927/98/9957 Latch Mtg. Pkg/2 for >3-1/4" - 3-3/4" Dr	900523	-	\$123.00	-	-	-	-	-	-
98/9927/98/9957 Latch Mtg. Pkg/2 for >3-3/4" - 4-1/4" Dr	900524	-	\$123.00	-	-	-	-	-	-
98/9927/98/9957-F LBR Latch Mounting Package	900980	-	\$13.00	-	-	-	-	-	-
WS98/9927 Soffit Release Bracket Package	900241	-	\$33.00	-	-	-	-	-	-
WS98/9927 Latch Mounting Package	900242	.[Finish]	-	-	-	\$32.00	\$32.00	\$32.00	\$32.00
98/9947 Latch Mounting Bracket Kit	109324	-	\$60.00	-	-	-	-	-	-
98/9948 Latch Mounting Bracket Kit**	112868	-	\$68.00	-	-	-	-	-	-
98/9947 Latch Brkt Mtg. Screw (Latch) Pkg/6	090059	-	\$14.00	-	-	-	-	-	-
98/9947 Latch Brkt Mtg. Screw (Door) Pkg/6	090061	-	\$14.00	-	-	-	-	-	-
98/9947/48 Latch Linkage Pin Retaining Ring Pkg/10	090063	-	\$14.00	-	-	-	-	-	-
98/9947 Latch Link Pin Pkg/10	090064	-	\$14.00	-	-	-	-	-	-
98/9947 Bolt Return Spring Pkg/10	090065	-	\$14.00	-	-	-	-	-	-
98/9947 Top Latch Compression Spring Pkg/10	090066	-	\$13.00	-	-	-	-	-	-
98/9947WDC/WDC-F Auxiliary Mtg. Package	900856	-	\$14.00	-	-	-	-	-	-
98/9947WDC Offset Link Pkg	900871	-	\$14.00	-	-	-	-	-	-
98/9927 RG/Latch Mtg. Pkg 2-1/4" - 2-3/4"	900527	.[Finish]	-	-	\$111.00	-	\$111.00	\$135.00	-
98/9927 RG/Latch Mtg. Pkg 2-3/4" - 3-1/4"	900528	.[Finish]	-	-	\$111.00	-	\$111.00	\$135.00	-
98/9927 RG/Latch Mtg. Pkg 3-1/4" - 3-3/4"	900529	.[Finish]	-	-	\$135.00	-	\$135.00	\$158.00	-
98/9927 RG/Latch Mtg. Pkg 3-3/4" - 4-1/4"	900530	.[Finish]	-	-	\$135.00	-	\$135.00	\$158.00	-
WS98/9927 Bottom Latch Assy Kit	048002	-	\$200.00	-	-	-	-	-	-
WS98/9927 Top Latch Assy Kit	048003	-	\$276.00	-	-	-	-	-	-

* For Devices shipped before October, 1998

**For service replacement only. Refer to Retrofit Kits 050047, 050048, 050522 and 050523 to convert 98/9947 Device to 98/9948.

✓ 630 AND 619 finishes available with Series 98 only.

PARTS AND ACCESSORIES

605	606	611	612	613	619	622	625	626	626AM	628	629
US3	US4	US9	US10	US10B	US15	US19	US26	US26D	US26DAM	US28	US32
630	630AM	643e	689	691	693	695	706	710	711	721	728
US32D	US32DAM	-	SP28	SP10	SPBLK	SP313	SP4	313	315	US3A	US4A

VERTICAL RODS												
Description	Specify		Non-Finished	628	626	✓630	710	711	612	606	605, 625, 643e	✓619
	Part number	Finish										
9927/9957 Top Rod Kit	050512	.[Finish]	-	\$84.00	-	-	\$99.00	\$115.00	\$115.00	\$115.00	\$115.00	-
9827/9857 Top Rod Kit	050513	.[Finish]	-	\$84.00	-	\$99.00	\$99.00	\$115.00	\$115.00	\$115.00	\$115.00	\$115.00
WS98/9927 Top Rod	101025	.[Finish]	-	-	-	\$174.00	\$174.00	\$174.00	\$174.00	\$369.00	\$369.00	\$369.00
WS 98/9957 Top Rod Assy Kit	048000	.[Finish]	-	-	-	\$200.00	\$200.00	\$200.00	-	\$339.00	\$536.00	\$200.00
9927/9957 Bottom Rod Kit	050514	.[Finish]	-	\$84.00	-	-	\$99.00	\$115.00	\$115.00	\$115.00	\$115.00	-
9827/9857 Bottom Rod Kit	050515	.[Finish]	-	\$84.00	-	\$99.00	\$99.00	\$115.00	\$115.00	\$115.00	\$115.00	\$115.00
WS98/9927 Bottom Rod	101026	.[Finish]	-	-	-	\$174.00	\$174.00	\$174.00	\$174.00	\$369.00	\$369.00	\$369.00
WS 98/9957 Bottom Rod Assy Kit	048001	.[Finish]	-	-	-	\$200.00	\$200.00	\$200.00	-	\$339.00	\$536.00	\$200.00
98/9947/48 Adj. Top Rod Kit - 6'8"-8'4" Dr	050574	-	\$99.00	-	-	-	-	-	-	-	-	-
98/9947/48 Bottom Rod Kit	050575	-	\$99.00	-	-	-	-	-	-	-	-	-
98/9947WDC Top Rod - 6'8"-8'4" Dr	050582	-	\$171.00	-	-	-	-	-	-	-	-	-
98/9947WDC Bottom Rod	050583	-	\$171.00	-	-	-	-	-	-	-	-	-
9927/9957 One Piece Top Rod Kit - 8'	050650	.[Finish]	-	\$249.00	\$249.00	-	\$249.00	\$249.00	\$158.00	\$126.00	\$249.00	-
9927/9957 One Piece Top Rod Kit - 10'	050651	.[Finish]	-	\$275.00	\$269.00	-	\$275.00	\$269.00	\$174.00	\$152.00	\$269.00	-
9927/9957 One Piece Top Rod Kit - 12'	050652	.[Finish]	-	\$291.00	\$302.00	-	\$291.00	\$302.00	\$192.00	\$179.00	\$302.00	-
9827/9857 One Piece Top Rod Kit - 8'	050653	.[Finish]	-	\$249.00	\$249.00	\$249.00	\$249.00	\$249.00	\$158.00	\$126.00	\$249.00	\$249.00
9827/9857 One Piece Top Rod Kit - 10'	050654	.[Finish]	-	\$275.00	\$275.00	\$275.00	\$275.00	\$269.00	\$174.00	\$152.00	\$269.00	\$269.00
9827/9857 One Piece Top Rod Kit - 12'	050655	.[Finish]	-	\$291.00	\$275.00	\$302.00	\$291.00	\$302.00	\$192.00	\$179.00	\$302.00	\$302.00
9927/9957 Extension Rod 36" Kit	051802	.[Finish]	-	\$31.00	\$31.00		\$31.00	\$31.00	\$31.00	\$31.00	\$31.00	-
9827/9857 Extension Rod 36" Kit	051810	.[Finish]	-	\$31.00	\$31.00	\$31.00	\$31.00	\$31.00	\$31.00	\$31.00	\$31.00	\$31.00
9927/9957 Extension Rod 60" Kit	050642	.[Finish]	-	\$145.00	\$145.00		\$145.00	\$279.00	\$266.00	\$177.00	\$279.00	-
9827/9857 Extension Rod 60" Kit	050644	.[Finish]	-	\$145.00	\$145.00	\$149.00	\$149.00	\$291.00	\$277.00	\$182.00	\$291.00	\$149.00
WS98/9927/57 Extension Rod 12" Kit	051812	.[Finish]	-	-	-	\$31.00	\$31.00	\$31.00	\$31.00	\$31.00	\$31.00	\$31.00
98/9947/48 Extension Rod Kit - Adj 8'4"-10'	051808	-	\$31.00	-	-	-	-	-	-	-	-	-
98/9947/48 Extension Rod Kit - Adj 10'-11'8"	050622	-	\$103.00	-	-	-	-	-	-	-	-	-
98/9947/48 Extension Rod Kit - Adj 11'8"-13'4"	050623	-	\$115.00	-	-	-	-	-	-	-	-	-
98/9947/48 Extension Rod Kit - Adj 13'4"-15'	050624	-	\$115.00	-	-	-	-	-	-	-	-	-
98/9927/98/9957-F Rod Guide Assembly	112063	.[Finish]	-	\$57.00	\$68.00	\$68.00	\$57.00	\$57.00	\$88.00	\$88.00	\$134.00	\$134.00
98/9927/98/9957-F Rod Guide Mtg. Package	900919	.[Finish]	-	-	\$14.00	\$14.00	\$14.00	\$14.00	\$14.00	\$14.00	\$14.00	\$14.00
98/9927/98/9957 Rod Roll Pin Pkg/10	090054	-	\$15.00	-	-	-	-	-	-	-	-	-
98/9927/98/9957 Rod Connector-Latch Pkg/2	090067	-	\$22.00	-	-	-	-	-	-	-	-	-

* For Devices shipped after July, 1997.
 ✓ 630 AND 619 finishes available with Series 98 only.

PARTS AND ACCESSORIES

605	606	611	612	613	619	622	625	626	626AM	628	629
US3	US4	US9	US10	US10B	US15	US19	US26	US26D	US26DAM	US28	US32
630	630AM	643e	689	691	693	695	706	710	711	721	728
US32D	US32DAM	-	SP28	SP10	SPBLK	SP313	SP4	313	315	US3A	US4A

VERTICAL RODS												
Description	Specify		Non-Finished	628	626	✓630	710	711	612	606	605, 625, 643e	✓619
	Part number	Finish										
98/9927/98/9957 Rod Connector-C/ Case Pkg/2	090068	-	\$22.00	-	-	-	-	-	-	-	-	-
98/9927/98/9957 Top or Bottom Rod Connector	050547	-	\$12.00	-	-	-	-	-	-	-	-	-
* 98/9947 Rod Connecting Screw Pkg/2	090071	-	\$17.00	-	-	-	-	-	-	-	-	-
98/9948 Rod Connecting Screw Pkg/2	090072	-	\$17.00	-	-	-	-	-	-	-	-	-
98/9927/98/9957 Rod Extension Connector Pkg/4	090075	-	\$15.00	-	-	-	-	-	-	-	-	-
98/9947 Ratchet Release Kit	106222	.[Finish]	-	\$146.00	-	\$146.00	\$146.00	\$146.00	\$146.00	\$146.00	-	-
98/9947 Ratchet Release Spacer 1/8"	970978	.[Finish]	-	\$23.00	-	\$23.00	\$23.00	-	\$23.00	\$23.00	-	-
98/9947 Ratchet Lever Spring Pkg/2	090069	-	\$13.00	-	-	-	-	-	-	-	-	-
98/9947 Ratchet Release Screw Pkg/2	090070	-	\$17.00	-	-	-	-	-	-	-	-	-
98/9947 Rod Adjusting Package	900620	-	\$23.00	-	-	-	-	-	-	-	-	-
98/9947 Adjusting Screw LBR Package	900898	-	\$14.00	-	-	-	-	-	-	-	-	-
98/9947 1/2" Insulclad Kit	051841	-	\$280.00	-	-	-	-	-	-	-	-	-
98/9947 1/4" Insulclad Kit	051842	-	\$170.00	-	-	-	-	-	-	-	-	-

* For Devices shipped after July, 1997.
 ✓ 630 AND 619 finishes available with Series 98 only.

QUIET MECHANICAL RETROFIT KITS	Specify	Price each
QM RIM Device Kit (98/99, 33A/35A)	47259560	\$199.00
QM SVR Device Kit (98/9927, 3327A/3527A)	47263418	\$199.00
QM 996 -R/V trim Kit	47260610	\$230.00
Damper Assembly, 996	47259557	\$67.00

DOUBLE CYLINDER	Specify	Price each
Lock / Unlock label only	971220-00	\$12.00

PNEUMATIC ACCESSORIES	Specify	Price each
PNT-1 - Pneumatic power transfer	012014-36	\$664.00
PN connector - PN adapter kit - 5/32" to 1/4" LCN tubing	051827-00	\$41.00
PN 5/32" tubing - 25' length	051828-00	\$27.00
PN 5/32" tubing - 50' length	051823-00	\$35.00
PN 5/32" tubing - 100' length	051824-00	\$60.00
PN 5/32" tubing - 200' length	051825-00	\$113.00

Z2 SERIES
 33A/35A SERIES
 55 SERIES
 88 SERIES
 98/99 SERIES
 XP98/XP99 SERIES
 94/95 SERIES
 GUARD-X SERIES
 ACCESSORIES / PARTS
 ELECTRICAL / PARTS

PARTS AND ACCESSORIES

605	606	611	612	613	619	622	625	626	626AM	628	629
US3	US4	US9	US10	US10B	US15	US19	US26	US26D	US26DAM	US28	US32
630	630AM	643e	689	691	693	695	706	710	711	721	728
US32D	US32DAM	-	SP28	SP10	SPBLK	SP313	SP4	313	315	US3A	US4A

98/9949 Series

VERTICAL LATCHES	Specify	Price each
49 Top Latch Assembly	24090110	\$274.00
49 Bottom Latch Assembly	24090128	\$295.00

CENTERSLIDE KITS	Specify	Price each
98/9949 Centerslide Kit	24090144	\$420.00

49 CABLE*	Specify	Price each
Top Cable Assembly Door Opening Heights 6'0" to 6'10"	47250398	\$238.00
Top Cable Assembly Door Opening Heights 6'10" to 8'0"	47250175	\$238.00
Top Cable Assembly Door Opening Heights >8'0" to 9'2"	47250176	\$238.00
Top Cable Assembly Door Opening Heights >9'2" to 10'4"	47250177	\$238.00
Bottom Cable Assembly Door Opening Heights 6'0" to 6'10"	47250403	\$238.00
Bottom Cable Assembly Door Opening Heights 6'10" to 8'0"	47250178	\$238.00
Bottom Cable Assembly Door Opening Heights >8'0" to 9'2"	47250179	\$238.00
Bottom Cable Assembly Door Opening Heights >9'2" to 10'4"	47250180	\$238.00
Replacement Cable Kit (10' core wire, end fitting, and sizing templates)	47250968	\$99.00

For door opening heights more than 10', consult factory.

Consult customer support for non-standard center lines or if a threshold is installed.

* For Complete 49 Cable System kits, see page 103.

MOUNTING PACKAGES	Specify	Price each
49 Bottom Mounting Package	23946437	\$75.00
49 Top Mounting Package	23946429	\$51.00
98/9949 HM/AL Centerslide Mounting	23946445	\$33.00

MISC.	Specify	Price each
Cable Removal Tool - qty 1	24052979	\$16.00
Cable Removal Tool - Pkg/10	24090706	\$126.00
338 Filler Plate	24230914	\$95.00
Spacer Block Kit 3/4" undercut	24231516	\$32.00

PARTS AND ACCESSORIES

605	606	611	612	613	619	622	625	626	626AM	628	629
US3	US4	US9	US10	US10B	US15	US19	US26	US26D	US26DAM	US28	US32
630	630AM	643e	689	691	693	695	706	710	711	721	728
US32D	US32DAM	-	SP28	SP10	SPBLK	SP313	SP4	313	315	US3A	US4A

98/9950WDC Series

VERTICAL LATCHES	Specify	Price each
Top Latch Kit with mounting pack	48968820	\$384.00
Bottom Latch Kit with mounting pack	48968838	\$321.00

CENTERSLIDE KITS	Specify	Price each
9950WDC Centerslide kit with mounting pack	48973291	\$630.00

FIRE KITS	Specify	Price each
98/9950WDC-F Fire Kit (fire barrier, intumescent for scalp plate and barrier, mounting packs)	48968861	\$255.00

MOUNTING KIT	Specify	Price each
Top, Bottom, and centerslide Mounting Pkg	24685505	\$33.00
Top Latch Mounting Kit	49000409	\$14.00
Bottom Latch Mounting Kit	49000391	\$14.00

CABLES	Specify	Price each
Top Cable 6'8"-7'0" WDC	24648180	\$58.00
Top Cable 7'1"-8'0" WDC	24647273	\$58.00
Top Cable 8'1"-9'0" WDC	24647281	\$66.00
Top Cable 9'1"-10'0" WDC	24647299	\$66.00
Bottom Cable WDC	24647265	\$58.00

FIRE PIN KIT	Specify	Price each
50WDC Fire pin Kit (current fire pin , fire pin sleeve, fire pin strike)	48968887	\$174.00

LIFT FINGER KIT	Specify	Price each
98/9950WDC Finger Kit	47258386	\$76.00
98/9950WDC Lift Finger Retrofit Kit	47260629	\$158.00
SD WDC Finger Kit	47244842	\$95.00

XP98/XP99 SERIES

605	606	611	612	613	619	622	625	626	626AM	628	629
US3	US4	US9	US10	US10B	US15	US19	US26	US26D	US26DAM	US28	US32
630	630AM	643e	689	691	693	695	706	710	711	721	728
US32D	US32DAM	-	SP28	SP10	SPBLK	SP313	SP4	313	315	US3A	US4A

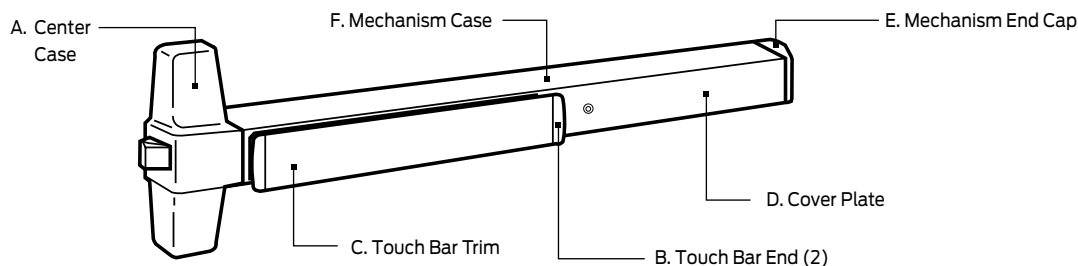

STANDARD FINISHES					
COLOR	US NUMBER	BHMA NUMBER	A, B, E	C - TOUCH BAR TRIM FINISHES	D, F
Bright Brass	US3	605	Bright Brass	Bright Brass US3, 605	Buffed Anodized
Satin Brass	US4	606	Satin Brass	Satin Brass US4, 606	Anodized
Satin Bronze	US10	612	Plated/Anodized	Satin Bronze US10, 725	Anodized
Satin Nickel	US15	619	Plated, Clear Powder Coat	Satin Stainless Steel US32D, 630	Anodized
Polished Chrome	US26	625	Plated	Bright Stainless Steel US32, 629	Buffed Anodized
Satin Chrome	US26D	626	Powder Coat	Satin Stainless Steel US32D, 630	Anodized
Anodized Aluminum	US28	628	Powder Coat	Satin Stainless Steel US32D, 630	Anodized
Satin Stainless Steel	US32D	630	Stainless Steel	Satin Stainless Steel US32D, 630	Anodized
Duranodic Dark Bronze	313	710	Powder Coat	Powder Coat 313, 710	Powder Coat
Black	315	711	Powder Coat	Powder Coat 315, 711	Powder Coat

Note: 619: Satin Nickel (US15) XP98 Series only.

SPECIAL FINISHES					
COLOR	US NUMBER	BHMA NUMBER	A, B, E	C - TOUCH BAR TRIM FINISHES	D, F
Bright Bronze	US9	611	Plated	Bright Bronze US9, 611	Buffed Anodized
Satin Bronze, Oil-Rubbed	US10B	613	Oil-Rubbed	Oil-Rubbed, US10B	Powder Coat
Satin Chrome, Antimicrobial	US26D-AM	626-AM	AM Clear over Chrome	AM Clear over Satin Stainless Steel US32D, 630	AM Clear over Anodized
Satin Stainless Steel, Antimicrobial	US32D-AM	630-AM	AM Clear over Stainless Steel	AM Clear over Satin Stainless Steel US32D, 630	AM Clear over Anodized
Powder Coat	RAL # *	--	Powder Coat	Satin Stainless Steel US32D, 630 (unless specified to match device)	Powder Coat

* See Finish page for optional RAL color information.

FINISH NOTES: 619 and 630 finishes available on Series XP98 only. Devices ordered in 628 and 630 will be supplied with Trims in 626.

XP98 / XP99 SERIES SEX BOLT QUANTITIES		
APPLICATION	425 SEX BOLT (OPTIONAL)	825 SEX BOLT (SUPPLIED)
DT, EO, NL, TP, K or L Device with trim	2	
99 NLOP Device with 110MD/WD	6	
99 EO Device (exit device only)	6	
99-F Wood Door with trim		2

 Indicates products that have EPD documentation available and meet LEED v4.

XP98/XP99 SERIES

605	606	611	612	613	619	622	625	626	626AM	628	629
US3	US4	US9	US10	US10B	US15	US19	US26	US26D	US26DAM	US28	US32
630	630AM	643e	689	691	693	695	706	710	711	721	728
US32D	US32DAM	-	SP28	SP10	SPBLK	SP313	SP4	313	315	US3A	US4A

TYPE OF DEVICE

XP98 or XP99
Rim

FUNCTION

DT: Dummy Trim	EO: Exit Only	K: Knob	KBE: Knob Blank Escutcheon
KDT: Knob Dummy	KNL: Knob Night Latch	L: Lever, 06 Standard	LBE (Lever-Blank Escutcheon)
LDT: Lever, Dummy Trim	LNL: Lever-Night Latch	NL: Night Latch, Key Retracts	NLOP: Night Latch, Opt. Pull
TP: Thumbpiece	TPBE: Thumbpiece - Blank Escutcheon		

RATING

None: Panic Exit Device - F: Fire Exit Device

DOUBLE CYLINDER

-2: Double Cylinder

DEVICE FINISH

605: Bright Brass (US3)	606: Satin Brass (US4)	611: Bright Bronze (US9)	612: Satin Bronze (US10)
613: Satin Bronze-Oil Rubbed (US10B)	625: Bright Chrome (US26)	626: Satin Chrome (US26D)	626AM: Antimicrobial (US26D-AM)
628: Anodized Aluminum (US28)	710: Duranodic Dark Bronze (313)	711: Black (315)	643e: Aged Bronze

Note: 619: Satin Nickel (US15) XP98 Series only.

DEVICE LENGTH (FEET AND INCHES)

3': 3' Device for 2' 4" - 3' Door 4': 4' Device for 2' 10" - 4' Door

DEVICE HANDING







RHR: Right Hand Reverse LHR: Left Hand Reverse

TRIM OPTIONS

LT: Less Trim	110MD / 110WD: Standard on NL-OP	392-7: Optional Pull Dummy Trim	696 / 696WDF: Optional Lever Trim
697 / 697WDF: Optional Lever Trim	VR910: Vandal Resistant	990: Standard Rim	996: Standard. Lever Trim

M996: Motorized 996

CONTROL LEVER STYLES 06 LEVER STANDARD

Standard levers:	01	02	03	05	06	07	12	16	17	18
	ACC: Accent 	AST: Asti 	MER: Merano 	LAT: Latitude	LON: Longitude					
Knurled levers:	03K	06K	M81K							
M Collection lever:	M51	M52	M53	M54	M55	M56	M61 	M63 		
	M81	M82	M83	M84	M85 	ME1	ME2	ME3		
Stainless steel levers:	03SS	06SS	17SS	LATSS	LONSS	M57	M62 			

XP98/XP99 SERIES

605	606	611	612	613	619	622	625	626	626AM	628	629
US3	US4	US9	US10	US10B	US15	US19	US26	US26D	US26DAM	US28	US32
630	630AM	643e	689	691	693	695	706	710	711	721	728
US32D	US32DAM	-	SP28	SP10	SPBLK	SP313	SP4	313	315	US3A	US4A

TRIM FINISH

605: Bright Brass (US3)	606: Satin Brass (US4)	612: Satin Bronze (US10)	613: Satin Bronze-Oil Rubbed (US10B)
619: Satin Nickel (US15)	625: Bright Chrome (US26)	626: Satin Chrome (US26D)	693: Painted Black (SPBLK)
710: Duranodic Dark Bronze (313)			

DOGGING OPTIONS

CD: Cylinder Dogging, Panic Only	CDSI: Cylinder Dogging with Indicator	CI: Cylinder Dogging Indicator	DI: Dogging Indicator
HDSI: Hex Dogging with Indicator	LD: Less Dogging	SD: Special Dogging	

SWITCH OPTIONS

LXLC: LBM Low Current	LXRXL: LBM Request to Exit Low Current	RX: Request to Exit	RX2: Request to Exit Double Switch
RXLC: Request to Exit Low Current	WPRX: Waterproof Request to Exit		

LATCH RETRACTION OPTIONS - PANIC ONLY

EL: Electric Latch Retraction	QEL: Quiet Electric Latch Retraction
-------------------------------	--------------------------------------

CX DELAYED EGRESS

CX: Chexit - Controlled Exit	CXRCM: Remote Chexit Module
------------------------------	-----------------------------

ACCESSIBLE DEVICE

AX: Accessible device compliant with the California Building Code (Section 11B-309.4) requirement for 5 lb. maximum operational force.

STRIKE SERIES

LS: Less Strike	909: Standard Panic and Fire	954: Optional mullion
-----------------	------------------------------	-----------------------

STRIKE FINISH

622: Matte Black (US19)

TOUCH BAR TRIM OPTIONS

BR: Braille	EMB: Embossed "Push"	KN: Knurled	RSS: Emergency Exit (630 only)
SG: Safety Glow			

DRAINAGE / WEEP HOLES

WH: Drainage/Weep Holes in Mechanism Case (3' device will have 4 holes, 6" spacing; 4' device will have 6 holes, 6" spacing)

CX DELAYED EGRESS RELEASE DELAY

15SEC: 15 second delay	BOCA15SEC: BOCA 15 second delay	M15SEC: 15 second mute delay	OSEC: 0 second delay
30SEC: 30 second delay	BOCA30SEC: BOCA 30 second delay	INFDEL: Infinite delay	2-60 Seconds: 2 second intervals

XP98/XP99 SERIES

605	606	611	612	613	619	622	625	626	626AM	628	629
US3	US4	US9	US10	US10B	US15	US19	US26	US26D	US26DAM	US28	US32
630	630AM	643e	689	691	693	695	706	710	711	721	728
US32D	US32DAM	-	SP28	SP10	SPBLK	SP313	SP4	313	315	US3A	US4A

TOUCH BAR FINISH

605: Bright Brass (US3)	606: Satin Brass (US4)	612: Satin Bronze (US10)	613: Satin Bronze-Oil Rubbed (US10B)
622: Matte Black (US19)	629: Bright Stainless (US32)	630AM: Satin Stainless (US32D-AM)	630: Satin Stainless (US32D)
695: Duranodic Dark Bronze (313)			

MISC DEVICE OPTIONS

ALK: Standard Alarm Kit	CYL: Include Cylinder	SNB: Include # of Sex Bolts
-------------------------	-----------------------	-----------------------------

CONNECTOR

CON: Connectors

SLM BLOCKING

SLM: SLM Blocking

SECURITY SCREWS

SEC: Include Security Screws

GBK/SHIM KIT/RISES

GBK: Include GBK

DOOR MATERIAL

ALD: Aluminum door	CP: Composite door	HMD: Hollow metal	WD: Wood door
--------------------	--------------------	-------------------	---------------

DOOR THICKNESS

DT1-3/4: 1-3/4" Standard	DT2: 2" thickness	DT2-1/4: 2-1/4" thickness
--------------------------	-------------------	---------------------------

DOOR APPLICATION

DE: Pair Double egress doors with mullion	PR: Pair of doors with mullion	SGL: Single door
---	--------------------------------	------------------

605	606	611	612	613	619	622	625	626	626AM	628	629
US3	US4	US9	US10	US10B	US15	US19	US26	US26D	US26DAM	US28	US32
630	630AM	643e	689	691	693	695	706	710	711	721	728
US32D	US32DAM	-	SP28	SP10	SPBLK	SP313	SP4	313	315	US3A	US4A

XP98/XP99 SERIES

Rim devices

ACN							PRICE BASED ON FINISH							Default trim, included		
Device type	Function	Fire	Finish	Device size	Handling	Lever design	605 [Ⓜ] 619 ¹ 625 643E									
							626	628	630 ¹	710	612	606 [Ⓜ]	711		613 ²	
EXIT HARDWARE							3' DEVICE PRICING SHOWN. 4' ADD \$19.00 LIST									
XP[98/99]	EO	.	[]	[]	.		\$1,607	\$1,460	\$1,649	\$1,543	\$1,649	\$1,702	\$1,884	\$2,293	\$1,893	N/A
XP[98/99]	DT	.	[]	[]	.		\$1,876	\$1,729	\$1,918	\$1,825	\$1,931	\$1,919	\$2,178	\$2,575	\$2,175	990DT
XP[98/99]	NL	.	[]	[]	[]		\$1,892	\$1,745	\$1,934	\$1,841	\$1,947	\$1,935	\$2,194	\$2,591	\$2,191	990NL-R/V
XP[98/99]	NL-OP	.	[]	[]	.		\$1,747	\$1,600	\$1,789	\$1,683	\$1,789	\$1,832	\$2,024	\$2,433	\$2,033	110MD/WD
XP[98/99]	TP	.	[]	[]	.		\$1,994	\$1,847	\$2,036	\$1,941	\$2,036	\$2,024	\$2,300	\$2,691	\$2,291	990TP-R/V
XP[98/99]	TP-BE	.	[]	[]	.		\$1,994	\$1,847	\$2,036	\$1,941	\$2,036	\$2,024	\$2,300	\$2,691	\$2,291	990TP-BE-R/V
XP[98/99]	K	.	[]	[]	.		\$2,083	\$1,936	\$2,125	\$2,019	\$2,189	\$2,102	\$2,459	\$2,769	\$2,369	996K-R/V
XP[98/99]	K-BE	.	[]	[]	.		\$2,083	\$1,936	\$2,125	\$2,019	\$2,189	\$2,102	\$2,459	\$2,769	\$2,369	996K-BE-R/V
XP[98/99]	K-DT	.	[]	[]	.		\$2,073	\$1,926	\$2,115	\$2,009	\$2,179	\$2,092	\$2,449	\$2,759	\$2,359	996K-DT-R/V
XP[98/99]	K-NL	.	[]	[]	.		\$2,073	\$1,926	\$2,115	\$2,009	\$2,179	\$2,092	\$2,449	\$2,759	\$2,359	996K-NL-R/V
XP[98/99]	L	.	[]	[]	[]	[]	\$2,226	\$2,079	\$2,268	\$2,162	\$2,323	\$2,290	\$2,585	\$2,912	\$2,534	996L-R/V
XP[98/99]	L-BE	.	[]	[]	[]	[]	\$2,226	\$2,079	\$2,268	\$2,162	\$2,323	\$2,290	\$2,585	\$2,912	\$2,534	996L-BE-R/V
XP[98/99]	L-DT	.	[]	[]	[]	[]	\$2,100	\$1,953	\$2,142	\$2,036	\$2,197	\$2,164	\$2,459	\$2,786	\$2,408	996L-DT-R/V
XP[98/99]	L-NL	.	[]	[]	[]	[]	\$2,100	\$1,953	\$2,142	\$2,036	\$2,197	\$2,164	\$2,459	\$2,786	\$2,408	996L-NL-R/V
FIRE EXIT HARDWARE							3' DEVICE PRICING SHOWN. 4' ADD \$19.00 LIST									
XP[98/99]	EO	F	[]	[]	[]		\$1,809	\$1,662	\$1,851	\$1,745	\$1,851	\$1,904	\$2,086	\$2,495	\$2,095	N/A
XP[98/99]	DT	F	[]	[]	[]		\$2,078	\$1,931	\$2,120	\$2,027	\$2,133	\$2,121	\$2,380	\$2,777	\$2,377	990DT
XP[98/99]	NL	F	[]	[]	[]		\$2,094	\$1,947	\$2,136	\$2,043	\$2,149	\$2,137	\$2,396	\$2,793	\$2,393	990NL-R/V
XP[98/99]	NL-OP	F	[]	[]	[]		\$1,949	\$1,802	\$1,991	\$1,885	\$1,991	\$2,034	\$2,226	\$2,635	\$2,235	110MD/WD
XP[98/99]	TP	F	[]	[]	[]		\$2,196	\$2,049	\$2,238	\$2,143	\$2,238	\$2,226	\$2,502	\$2,893	\$2,493	990TP-R/V
XP[98/99]	TP-BE	F	[]	[]	[]		\$2,196	\$2,049	\$2,238	\$2,143	\$2,238	\$2,226	\$2,502	\$2,893	\$2,493	990TP-BE-R/V
XP[98/99]	K	F	[]	[]	[]		\$2,285	\$2,138	\$2,327	\$2,221	\$2,391	\$2,304	\$2,661	\$2,971	\$2,571	996K-R/V
XP[98/99]	K-BE	F	[]	[]	[]		\$2,285	\$2,138	\$2,327	\$2,221	\$2,391	\$2,304	\$2,661	\$2,971	\$2,571	996K-BE-R/V
XP[98/99]	K-NL	F	[]	[]	[]		\$2,275	\$2,128	\$2,317	\$2,211	\$2,381	\$2,294	\$2,651	\$2,961	\$2,561	996K-NL-R/V
XP[98/99]	L	F	[]	[]	[]	[]	\$2,428	\$2,281	\$2,470	\$2,364	\$2,525	\$2,492	\$2,787	\$3,114	\$2,736	996L-R/V
XP[98/99]	L-BE	F	[]	[]	[]	[]	\$2,428	\$2,281	\$2,470	\$2,364	\$2,525	\$2,492	\$2,787	\$3,114	\$2,736	996L-BE-R/V
XP[98/99]	L-NL	F	[]	[]	[]	[]	\$2,302	\$2,155	\$2,344	\$2,238	\$2,399	\$2,366	\$2,661	\$2,988	\$2,610	996L-NL-R/V

[Ⓜ] Consult factory for lead time.

¹ 630 and 619 finishes available only on 98 Series.

² 613 finish has 710 finish device with 613 parts.

DEFAULT ATTRIBUTES

Pricing includes default options shown below. Additional options and configurations available.

Cylinders:	Sex bolts	Door thickness	Center line
Not included	Not included	1-3/4"	39-13/16"

Strike(s):

Exit hardware:

- Includes 909 strike

Fire exit hardware:

- Single door applications: Includes 909 strike
- Double door applications: 954 strike will be supplied at an additional \$112 list add

OPTIONS

605	606	611	612	613	619	622	625	626	626AM	628	629
US3	US4	US9	US10	US10B	US15	US19	US26	US26D	US26DAM	US28	US32
630	630AM	643e	689	691	693	695	706	710	711	721	728
US32D	US32DAM	-	SP28	SP10	SPBLK	SP313	SP4	313	315	US3A	US4A

ANTIMICROBIAL COATING - Available in 626 (US26D) and 630 (US32D), use suffix "AM" when ordering. 630AM (US32D-AM) available only on 98 Series devices. Example: 626AM	Specify (Suffix)	Price adjustment
For device with or without trim	AM	\$73.00
For trim only (626AM)	AM	\$34.00

CYLINDER DOGGING - Not for use with fire exit hardware	Specify (Prefix)	Price adjustment
Standard baseplate cylinder dogging	CD	\$104.00
Cylinder dogging indicator ¹	CI	\$285.00
Cylinder dogging with indicator	CDSI	\$342.00
Dogging indicator	DI	\$268.00
Hex dogging with indicator	HDSI	\$246.00
Less dogging	LD	\$0.00
Special dogging - panic only ²	SD	\$437.00

¹ Not available with EL/QEL electrical option.

² Available on panic devices only. May be used with EL option. Specify handing.

DOUBLE CYLINDER	Specify (Suffix)	Price adjustment
Double Cylinder ¹	-2	\$357.00
Double Cylinder with Security Indicator ²	-2SI	\$597.00

For Lock/Unlock label only, order part number 971220-00 for \$12 list price, each.

¹ Available with TP, K, and L functions only. Specify handing.

² Rim cylinder sold separately. Cylinder with T-Turn available from Schlage, order part # XB11-979. Available with TP, TP-BE, K, K-BE, L and L-BE functions only.

SWITCHES - Available on all 98/99 Series devices	Specify (Prefix)	Price adjustment
	Prefix for configured device	
Request to Exit	RX	\$266.00
Request to Exit Low Current	RX-LC	\$309.00
Request to Exit Double Switch	RX-2	\$331.00
RX to RX-2 Conversion (order part number 050271)	RX-AUX	\$277.00
Waterproof Request to Exit	WP-RX	\$384.00
Latchbolt Monitoring Low Current ¹	LX-LC	\$309.00
Request to Exit / Latchbolt Monitoring combination Low Current	LX-RX-LC	\$483.00

¹ The LX-LC switch is factory installed only.

See page 175-176 for field-installed switch kit part numbers.

OPTIONS

605	606	611	612	613	619	622	625	626	626AM	628	629
US3	US4	US9	US10	US10B	US15	US19	US26	US26D	US26DAM	US28	US32
630	630AM	643e	689	691	693	695	706	710	711	721	728
US32D	US32DAM	-	SP28	SP10	SPBLK	SP313	SP4	313	315	US3A	US4A

LATCH RETRACTION - See 98/99 product catalog for required accessory equipment	Specify (Prefix)	Price adjustment
Electric latch retraction	EL	\$1,015.00
Electric latch retraction with hex dogging (panic only)	HD-EL	\$1,015.00
Electric Latch Retraction with Special Center Case Dogging ¹ (Available with "EL" option)	SD-EL	\$1,452.00
Quiet electric latch retraction	QEL	\$979.00
Quiet electric latch retraction with hex dogging (panic only)	HD-QEL	\$979.00
Quiet Electric Latch Retraction with Special Center Case Dogging ¹ (Available with "QEL" option)	SD-QEL	\$1,416.00
Quiet electric latch retraction for AX devices	QELX	\$1,041.00
Quiet electric latch retraction with hex dogging (panic only) for AX devices	HD-QELX	\$1,041.00

¹ Available only on XP98/99 rim panic devices. Specify handling.

CHEXIT - Available on all XP98/99 Series devices	Specify (Prefix)			Price adjustment
	Prefix	Finish	Release delay	
Chexit – Controlled exit device (15 second delay furnished standard) <ul style="list-style-type: none"> Chexit is not available with any electrical options (EL, QEL, PN) Chexit is not available with any switches (RX, RXLC, RX2, WP-RX, LX, LXLC, LXR, LXRXC, SS) 	CXA	-	.[Release delay]	\$1,940.00
Remote Chexit module	RCM	.[Finish]	.[Release delay]	\$277.00
Chexit 10' cable	CXCAB	-	-	\$124.00

RELEASE DELAY	Specify	Price adjustment
0 Second Delay	0 Delay	\$142.00
30 Second Delay ¹	30 Delay ¹	\$142.00
15 second delay with BOCA Modification	BOCA-15 Delay [ⓧ]	\$142.00
30 second delay with BOCA Modification ¹	BOCA-30 Delay ¹ [ⓧ]	\$142.00
2-60 Seconds in 2 Second Intervals or infinite delay ¹	Other Delays ¹ [ⓧ]	\$190.00

15 second Module sold separately, specify part number 040086.

¹ Over 15 second delay requires a letter of approval from the authority having local jurisdiction over the premises prior to the installation of the device. Allegion cannot grant such approval nor does it warrant local jurisdiction compliance.

[ⓧ] Consult factory for lead time.

EXIT ALARM	Specify	Price adjustment
Exit alarm <ul style="list-style-type: none"> Price includes RX switch; can substitute with LXLC switch at no additional charge To order Less Switch, deduct \$266 list 9 volt battery included 	ALK	\$660.00

OPTIONS

605	606	611	612	613	619	622	625	626	626AM	628	629
US3	US4	US9	US10	US10B	US15	US19	US26	US26D	US26DAM	US28	US32
630	630AM	643e	689	691	693	695	706	710	711	721	728
US32D	US32DAM	-	SP28	SP10	SPBLK	SP313	SP4	313	315	US3A	US4A

ELECTRIC UNLOCKING	Specify (Prefix)	Price adjustment
<ul style="list-style-type: none"> Motor driven electric unlocking of outside M996 trim for 98/99 rim, mortise, surface vertical and concealed vertical devices Available with L or LBE functions only, specify handing Dual voltage - works with either 12 or 24 VDC power supplies, furnished Fail Safe (FS) but can be converted in the field with dip switch without mechanical conversion See page 142 for pricing and optional lever designs 	M996	\$666.00

ACCESSIBLE DEVICE	Specify (Prefix)	Price adjustment
<ul style="list-style-type: none"> Accessible device compliant with the California Building Code (Section 11B-309.4) requirement for 5 lb. maximum operational force. EL and QELX options available Not available with CX 	AX	\$67.00

TOUCHBAR OPTIONS	Specify		Price adjustment
	Suffix	Handing	
Vision impaired touchpad, raised letters and braille, 630 finish. Standard reads "Caution Stairwell." Optional up to 20 alpha / numeric characters on single line, consult factory.	BRILLE	.[RHR, LHR]	\$134.00
Brass, bronze and stainless touchbar trims embossed "PUSH". No additional charge when specified with device.	EMB	.[RHR, LHR]	\$0.00
Red silk-screened lettered touchbar trims (standard on SS devices). "Emergency Exit Only, Push to Open and Sound Alarm" No additional charge when specified with device.	RSS	.[RHR, LHR]	\$0.00
Knurled touchpad. No additional charge when specified with device.	KN	-	\$0.00
Safety glow feature for 3' device	SG	-	\$488.00
Safety glow feature for 4' device	SG	-	\$508.00

Custom graphics available on touchbar trim. See page 7 for details.

WEEP HOLES	Specify	Price adjustment
Drainage (weep) holes in mechanism case. 3' device will have 4 holes - 6" spacing, 4' device will have 6 holes	WH	\$96.00

CONNECTORS	Specify	Price adjustment
Cross-category solution using interconnect components for electrified options. Available with ALK, LXLC, RX and RXLC switches.	CON	\$0.00

NON-STANDARD DOOR THICKNESS	Specify	Price adjustment
Door thickness > 2-1/4" - <= 4 1/4"		
XP98/99 Rim devices EO (exit only no trim) with sex bolts	.DT[]	\$96.00
XP98/99 Rim devices NL-OP (with 110NL cylinder control) with sex bolts	.DT[]	\$192.00
XP98/99 Rim devices NL-OP (with 110NL cylinder control) NO sex bolts	.DT[]	\$96.00

KITS

605	606	611	612	613	619	622	625	626	626AM	628	629
US3	US4	US9	US10	US10B	US15	US19	US26	US26D	US26DAM	US28	US32
630	630AM	643e	689	691	693	695	706	710	711	721	728
US32D	US32DAM	-	SP28	SP10	SPBLK	SP313	SP4	313	315	US3A	US4A

EL CONVERSION KITS - Field conversion kits for Electric Latch Retraction	Specify				Price each
	Standard		Allegion Connect -CON		
	3' device	4' device	3' device	4' device	
EL baseplate conversion kit	050070	050078	050853	050854	\$1,184.00
HD-EL baseplate conversion kit (hex dogging included, panic only)	050384	050385	050855	050856	\$1,184.00

QEL CONVERSION KITS - Field conversion kits for Quiet Electric Latch Retraction	Specify				Price each
	Standard		Allegion Connect -CON		
	3' device	4' device	3' device	4' device	
Baseplate conversion kits (may be used for ANY conversion application)					
QEL baseplate conversion kit	958003	040065	040063	040066	\$1,029.00
HD-QEL baseplate conversion kit (hex dogging included, panic only)	958004	040067	040064	040068	\$1,029.00
QELX baseplate conversion kit for AX devices	041166	041167	041168	041169	\$1,091.00
HD-QELX Baseplate Conversion Kit for AX devices (hex dogging included, panic only)	041170	041171	041172	041173	\$1,091.00
Modular conversion kits (for non-EL panic devices, for non-EL fire-rated devices sold after October 2014, or for replacing existing motor)					
QEL modular conversion kit	114317	114317	040061	040061	\$979.00
HD-QEL modular conversion kit (hex dogging included, panic only)	958002	958002	040062	040062	\$979.00
QELX modular conversion kit for AX devices	041162	041162	041163	041163	\$1,041.00
HD-QELX modular conversion kit for AX devices (hex dogging included, panic only)	041164	041164	041165	041165	\$1,041.00

ESL (EMERGENCY SECURE LOCKDOWN) KITS	Specify			Price each
	3' device	4' device	Finish	
98 ESL Kit - Retrofit kit for QEL 98 devices; Panic or Fire (not available in 619 or 630)	967244	967245	.[Finish]	\$425.00
99 ESL Kit - Retrofit kit for QEL 99, devices; Panic or Fire	967246	967247	.[Finish]	\$425.00

- No WS
- No mechanical dogging of QEL (SD-QEL, HD-QEL)
- Unit requires a standard 1 1/4" (32mm) mortise cylinder with an inverted straight cam and compression ring and spring. Kit does not come with cylinder or thumbturn, must be ordered separately. Examples: Schlage conventional cylinder: 20-001 1 1/4" XQ11-949; Schlage thumbturn cylinder: 09-904 1 1/4" B502-191 XQ11-949; Schlage ADA thumbturn cylinder: 09-904 1 1/4" XB11-720 B502-191 XQ11-949
- Install in alignment with 2018 IBC 1010.2.8 NFPA 101 14.2.2.2.4 or per local AHJ - Only allowed with trim functions: NL, K-NL, L-NL, NL-OP, T-NL

CX OPTIONS	Specify		Price each
	Part number	Finish	
RCM KIT-98 Less Module	040199	.[Finish]	\$278.00
RCM KIT-99 Less Module	040198	.[Finish]	\$278.00

Note: 15 second Module sold separately. Specify part number 040086.

ELECTRICAL UNLOCKING RETROFIT KITS	Specify		Price each
	Part number	Finish	
996 R/V/C Conversion to M996 Motorized Kit		47273111	\$740.00
996 Mort Conversion to M996 Motorized Kit		47273112	\$770.00

PARTS AND ACCESSORIES

605	606	611	612	613	619	622	625	626	626AM	628	629
US3	US4	US9	US10	US10B	US15	US19	US26	US26D	US26DAM	US28	US32
630	630AM	643e	689	691	693	695	706	710	711	721	728
US32D	US32DAM	-	SP28	SP10	SPBLK	SP313	SP4	313	315	US3A	US4A

CENTER CASE

Description	Specify		Non-Finished	628, 710, 711	626	630	612	606	605, ✓619, 625
	Part number	Finish							
XP98/99R Center Case Kit Less Cover	050689	-	\$538.00	-	-	-	-	-	-
XP98/99R/-F Center Case Kit Less Cover	050690	-	\$558.00	-	-	-	-	-	-
XP98/99/-F Center Case Cover Kit	050691	.[Finish]	-	\$152.00	\$219.00	\$230.00	\$219.00	\$219.00	\$252.00
XP98/99/-F Center Case Cover Bracket	050692	-	\$30.00	-	-	-	-	-	-

RETROFIT KITS

Description	Specify		Non-Finished	628, 710, 711	626	630	612	606	605, ✓619, 625
	Part number	Finish							
XP99-909 - 98/99 Series Device conversion to XP with 909 strike	050676	.[Finish]	-	\$1,006.00	\$1,042.00	\$1,081.00	\$1,035.00	\$1,035.00	\$1,148.00
XP99-954 - 98/99 Series Device conversion to XP with 954 strike	050675	.[Finish]	-	\$1,118.00	\$1,154.00	\$1,192.00	\$1,148.00	\$1,148.00	\$1,238.00
XP98/99 Retrofit Kit Mounting Package	900297	-	\$24.00	-	-	-	-	-	-
XP98/99-2SI Conversion Kit RHR	090599	.[Finish]	-	\$1,578.00	\$1,646.00	\$1,697.00	\$1,697.00	\$1,646.00	\$1,714.00
XP98/99-2SI Conversion Kit LHR	090600	.[Finish]	-	\$1,578.00	\$1,646.00	\$1,697.00	\$1,697.00	\$1,646.00	\$1,714.00
XP98/99-2 Conversion Kit RHR	090601	.[Finish]	-	\$1,283.00	\$1,353.00	\$1,404.00	\$1,404.00	\$1,353.00	\$1,419.00
XP98/99-2 Conversion Kit LHR	090602	.[Finish]	-	\$1,283.00	\$1,353.00	\$1,404.00	\$1,404.00	\$1,353.00	\$1,419.00
XP98/99-F-2SI Conversion Kit RHR	090794	.[Finish]	-	\$1,777.00	\$1,846.00	\$1,897.00	\$1,897.00	\$1,846.00	\$1,914.00
XP98/99-F-2SI Conversion Kit LHR	090795	.[Finish]	-	\$1,777.00	\$1,846.00	\$1,897.00	\$1,897.00	\$1,846.00	\$1,914.00
XP98/99-F-2 Conversion Kit RHR	090796	.[Finish]	-	\$1,483.00	\$1,552.00	\$1,605.00	\$1,605.00	\$1,552.00	\$1,618.00
XP98/99-F-2 Conversion Kit LHR	090797	.[Finish]	-	\$1,483.00	\$1,552.00	\$1,605.00	\$1,605.00	\$1,552.00	\$1,618.00

MOUNTING PACKAGES

Description	Specify		Non-Finished
	Part number	Finish	
XP98/99 Rim Mtg. Pkg for >2-1/4" - 2-3/4" Dr	900424	-	\$95.00
XP98/99 Rim Mtg. Pkg for >2-3/4" - 3-1/4" Dr	900425	-	\$95.00
XP98/99 Rim Mtg. Pkg for >3-1/4" - 3-3/4" Dr	900426	-	\$95.00
XP98/99 Rim Mtg. Pkg for >3-3/4" - 4-1/4" Dr	900427	-	\$95.00

✓619 finishes available with XP98 only.

94/95 IMPACT SERIES

605	606	611	612	613	619	622	625	626	626AM	628	629
US3	US4	US9	US10	US10B	US15	US19	US26	US26D	US26DAM	US28	US32
630	630AM	643e	689	691	693	695	706	710	711	721	728
US32D	US32DAM	-	SP28	SP10	SPBLK	SP313	SP4	313	315	US3A	US4A

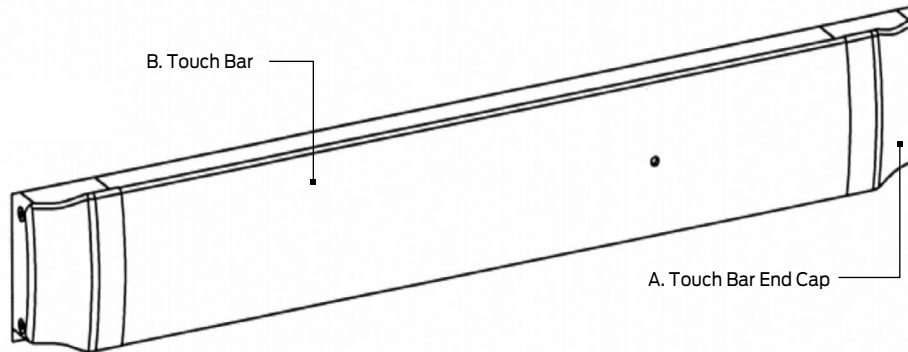

STANDARD FINISHES				
COLOR	US NUMBER	BHMA NUMBER	A	B -TOUCH BAR FINISHES*
Bright Brass	US3	605	Powder Coat - Black 315, 622	Bright Brass US3
Satin Brass	US4	606	Powder Coat - Black 315, 622	Satin Brass US4
Satin Bronze	US10	612	Powder Coat - Black 315, 622	Satin Bronze US10
Polished Chrome	US26	625	Powder Coat - Black 315, 622	Bright Stainless Steel US32
Satin Chrome	US26D	626	Powder Coat - Black 315, 622	Satin Stainless Steel US32D
Anodized Aluminum	US28	628	Powder Coat - Black 315, 622	Satin Stainless Steel US32D
Duranodic Dark Bronze	313	710	Powder Coat - Black 315, 622	Powder Coat 313, 710
Satin Chrome, Antimicrobial	US26D-AM	626-AM	AM Clear over 622	AM Clear over Anodized

* Anodized Equivalent
No Sex Bolts are needed for the 94/95 Series device.

95/95 IMPACT SERIES

605	606	611	612	613	619	622	625	626	626AM	628	629
US3	US4	US9	US10	US10B	US15	US19	US26	US26D	US26DAM	US28	US32
630	630AM	643e	689	691	693	695	706	710	711	721	728
US32D	US32DAM	-	SP28	SP10	SPBLK	SP313	SP4	313	315	US3A	US4A

TYPE OF DEVICE											
94/9547 Concealed Vertical Rod				94/9548 Concealed Vertical Rod				94/9575 Mortise Lock			
FUNCTION											
DT: Dummy Trim			EO: Exit Only			L: Lever, 06 Standard			LBE: Lever-Blank Escutcheon		
LDT: Lever, Dummy Trim			NL: Night Latch, Key Retracts			TL: Turn Lever			TLBE: Turn Lever - Blank Escutcheon		
TLOP: Turn Lever, Optional Pull											
RATING											
None: Panic Exit Device				- F: Fire Exit Device							
DEVICE FINISH											
605: Bright Brass (US3)			606: Satin Brass (US4)			612: Satin Bronze (US10)			625: Bright Chrome (US26)		
626: Satin Chrome (US26D)			626AM: Antimicrobial (US26D-AM)			628: Anodized Aluminum (US28)			710: Duranodic Dark Bronze (313)		
DEVICE HANDING											
RHR: Right Hand Reverse				LHR: Left Hand Reverse							
TRIM / CONTROL OPTIONS											
LC: Less Control			LT: Less Trim			376T: Thumbturn Control - CV			392-7: Opt. Wire Pull Trim		
550: Optional Offset Dummy Trim				940L: Lever Control							
CONTROL LEVER STYLES 06 LEVER STANDARD											
Standard levers:	01	02	03*	05	06*	07*	12*	16	17*	18	
	ACC: Accent ☞		AST: Asti ☞		MER: Merano ☞		LAT: Latitude		LON: Longitude		
Knurled levers:	03K	06K	M81K								
M Collection lever:	M51	M52	M53	M54	M55	M56	M61 ☞	M63 ☞			
	M81	M82	M83	M84	M85 ☞	ME1	ME2	ME3			
Stainless steel levers:	03SS	06SS	17SS	LATSS	LONSS	M57	M62 ☞				
*Trim lever styles.											
TRIM / CONTROL FINISH											
605: Bright Brass (US3)			606: Satin Brass (US4)			612: Satin Bronze (US10)			613: Satin Bronze-Oil Rubbed (US10B)		
622: Matte Black (US19)			625: Bright Chrome (US26)			626: Satin Chrome (US26D)			628: Anodized Aluminum (US28)		
693: Painted Black (SPBLK)			695: Painted Dark Bronze (SP313)			626AM: Antimicrobial (US26D-AM)					
MORTISE LOCK											
LL: Less Lock				7500IN: Standard Mortise				SS7500IN: Signal Switch			

95/95 INPACT SERIES

605	606	611	612	613	619	622	625	626	626AM	628	629
US3	US4	US9	US10	US10B	US15	US19	US26	US26D	US26DAM	US28	US32
630	630AM	643e	689	691	693	695	706	710	711	721	728
US32D	US32DAM	-	SP28	SP10	SPBLK	SP313	SP4	313	315	US3A	US4A

MORTISE LOCK FINISH

605: Bright Brass (US3)	606: Satin Brass (US4)	612: Satin Bronze (US10)	613: Satin Bronze-Oil Rubbed (US10B)
622: Matte Black (US19)	629: Bright Stainless (US32)	630: Satin Stainless (US32D)	689: Sprayed Aluminum (SP28)

RODS FOR SURFACE / CONCEALED VERTICAL DEVICES ONLY

LBR: Less Bottom Rod	LBRAFL: LBR with Auxiliary Fire Pin
----------------------	-------------------------------------

SWITCH OPTIONS

LX: Latchbolt Monitoring

LATCH RETRACTION OPTIONS

QEL: Quiet Electric Latch Retraction

ACCESSIBLE DEVICE

AX: Accessible device compliant with the California Building Code (Section 11B-309.4) requirement for 5 lb. maximum operational force.
--

STRIKE SERIES

LS: Less Strike	LTS: Less Top Strike	575: Standard Mortise	575-2: Optional Mortise
576A/576B: Optional Mortise	338: Standard Concealed Vertical Rod		

BOTTOM STRIKE SERIES

LBS: Less Bottom Strike	304L: Mortise	385A: Adjustable Mortise
-------------------------	---------------	--------------------------

STRIKE FINISH

605: Bright Brass (US3)	606: Satin Brass (US4)	612: Satin Bronze (US10)	613: Satin Bronze-Oil Rubbed (US10B)
622: Matte Black (US19)	629: Bright Stainless (US32)	630: Satin Stainless (US32D)	MD: e-Moly

DEVICE OPTIONS

CYL: Include Cylinder	PL: Pullman Latch w/ES Strike
-----------------------	-------------------------------

DOOR / FRAME MATERIAL

HMD: Hollow Metal

DOOR THICKNESS

DT1-3/4: 1-3/4" Standard

DOOR APPLICATION

DE: Pair Double egress doors	PR: Pair of doors	SGL: Single door
------------------------------	-------------------	------------------

94/95 INPACT SERIES

605	606	611	612	613	619	622	625	626	626AM	628	629
US3	US4	US9	US10	US10B	US15	US19	US26	US26D	US26DAM	US28	US32
630	630AM	643e	689	691	693	695	706	710	711	721	728
US32D	US32DAM	-	SP28	SP10	SPBLK	SP313	SP4	313	315	US3A	US4A

Concealed vertical rod devices (47)

ACN							PRICE BASED ON FINISH						Default trim, included
Device type	Function	Fire	Finish	Device size	Handing	Lever design	626	628	710	612	606	605 625	
EXIT HARDWARE							3' AND 4' DEVICE PRICING SHOWN.						
[94/95]47	EO	.	[] . []	.			\$1,831	\$1,726	\$1,767	\$1,851	\$1,934	\$2,084	N/A
[94/95]47	DT	.	[] . []	.			\$2,423	\$2,318	\$2,359	\$2,450	\$2,402	\$2,694	550DT
[94/95]47	L	.	[] . [] . [] . []	.			\$2,553	\$2,448	\$2,511	\$2,628	\$2,625	\$2,888	940L
[94/95]47	L-BE	.	[] . [] . [] . []	.			\$2,553	\$2,448	\$2,511	\$2,628	\$2,625	\$2,888	940L-BE
[94/95]47	L-DT	.	[] . [] . [] . []	.			\$2,637	\$2,532	\$2,595	\$2,712	\$2,709	\$2,972	940L-DT
[94/95]47	TL	.	[] . []	.			\$3,205	\$3,100	\$3,141	\$3,292	\$3,076	\$3,536	550DT/376T
[94/95]47	TL-BE	.	[] . []	.			\$3,162	\$3,057	\$3,098	\$3,249	\$3,033	\$3,493	550DT/376T-BE
FIRE EXIT HARDWARE							3' AND 4' DEVICE PRICING SHOWN.						
[94/95]47	EO	. F	[] . []	.			\$2,135	\$2,030	\$2,071	\$2,155	\$2,238	\$2,388	N/A
[94/95]47	DT	. F	[] . []	.			\$2,727	\$2,622	\$2,663	\$2,754	\$2,706	\$2,998	550DT
[94/95]47	L	. F	[] . [] . [] . []	.			\$2,857	\$2,752	\$2,815	\$2,932	\$2,929	\$3,192	940L
[94/95]47	L-BE	. F	[] . [] . [] . []	.			\$2,857	\$2,752	\$2,815	\$2,932	\$2,929	\$3,192	940L-BE
[94/95]47	TL	. F	[] . []	.			\$3,509	\$3,404	\$3,445	\$3,596	\$3,380	\$3,840	550DT/376T
[94/95]47	TL-BE	. F	[] . []	.			\$3,466	\$3,361	\$3,402	\$3,553	\$3,337	\$3,797	550DT/376T-BE

DEFAULT ATTRIBUTES

Pricing includes default options shown below. Additional options and configurations available.

Cylinders:	Sex bolts	Door thickness	Center line
Not included	Not included	1-3/4"	39-13/16"

Strike(s):

Exit hardware:

- Includes 338 and 385 strikes

Fire exit hardware:

- Includes 338 and 385A strikes

Z2 SERIES
33A/35A SERIES
55 SERIES
88 SERIES
98/99 SERIES
XP98/XP99 SERIES
94/95 SERIES
GUARD-X SERIES
ACCESSORIES / PARTS
ELECTRICAL / PARTS

94/95 INPACT SERIES

605	606	611	612	613	619	622	625	626	626AM	628	629
US3	US4	US9	US10	US10B	US15	US19	US26	US26D	US26DAM	US28	US32
630	630AM	643e	689	691	693	695	706	710	711	721	728
US32D	US32DAM	-	SP28	SP10	SPBLK	SP313	SP4	313	315	US3A	US4A

Concealed vertical rod devices (48)

ACN							PRICE BASED ON FINISH						Default trim, included
Device type	Function	Fire	Finish	Device size	Handing	Lever design	626	628	710	612	606	605 625	
EXIT HARDWARE							3' AND 4' DEVICE PRICING SHOWN.						
[94/95]48	EO		[]	[]			\$2,022	\$1,912	\$1,939	\$2,027	\$2,108	\$2,225	N/A
[94/95]48	DT		[]	[]			\$2,550	\$2,440	\$2,467	\$2,555	\$2,548	\$2,768	550DT
[94/95]48	L		[]	[]	[]	[]	\$2,717	\$2,607	\$2,654	\$2,773	\$2,803	\$3,006	940L
[94/95]48	L-BE		[]	[]	[]	[]	\$2,717	\$2,607	\$2,654	\$2,773	\$2,803	\$3,006	940L-BE
[94/95]48	L-DT		[]	[]	[]	[]	\$2,804	\$2,694	\$2,745	\$2,857	\$2,890	\$3,055	940L-DT
[94/95]48	TL		[]	[]			\$3,304	\$3,194	\$3,221	\$3,351	\$3,196	\$3,584	550DT/376T
[94/95]48	TL-BE		[]	[]			\$3,267	\$3,157	\$3,184	\$3,319	\$3,156	\$3,543	550DT/376T-BE
FIRE EXIT HARDWARE							3' AND 4' DEVICE PRICING SHOWN.						
[94/95]48	EO	F	[]	[]			\$2,294	\$2,193	\$2,245	\$2,326	\$2,412	\$2,596	N/A
[94/95]48	DT	F	[]	[]			\$2,822	\$2,721	\$2,773	\$2,854	\$2,852	\$3,139	550DT
[94/95]48	L	F	[]	[]	[]	[]	\$2,989	\$2,888	\$2,960	\$3,072	\$3,107	\$3,377	940L
[94/95]48	L-BE	F	[]	[]	[]	[]	\$2,989	\$2,888	\$2,960	\$3,072	\$3,107	\$3,377	940L-BE
[94/95]48	TL	F	[]	[]			\$3,576	\$3,475	\$3,527	\$3,650	\$3,500	\$3,955	550DT/376T
[94/95]48	TL-BE	F	[]	[]			\$3,539	\$3,438	\$3,490	\$3,618	\$3,460	\$3,914	550DT/376T-BE

DEFAULT ATTRIBUTES

Pricing includes default options shown below. Additional options and configurations available.

Cylinders:	Sex bolts	Door thickness	Center line
Not included	Not included	1-3/4"	39-13/16"

Strike(s):

Exit hardware:

- Includes 338 and 385 strikes

Fire exit hardware:

- Includes 338 and 385A strikes

94/95 INPACT SERIES

605	606	611	612	613	619	622	625	626	626AM	628	629
US3	US4	US9	US10	US10B	US15	US19	US26	US26D	US26DAM	US28	US32
630	630AM	643e	689	691	693	695	706	710	711	721	728
US32D	US32DAM	-	SP28	SP10	SPBLK	SP313	SP4	313	315	US3A	US4A

Mortise lock devices (75)

ACN							PRICE BASED ON FINISH						Default trim, included
Device type	Function	Fire	Finish	Device size	Handing	Lever design	626	628	710	612	606	605 625	
EXIT HARDWARE							3' AND 4' DEVICE PRICING SHOWN.						
[94/95]75	EO	.	[] . []	.			\$2,222	\$2,117	\$2,181	\$2,265	\$2,348	\$2,498	N/A
[94/95]75	DT	.	[] . []	.			\$2,814	\$2,709	\$2,773	\$2,864	\$2,816	\$3,108	550DT
[94/95]75	NL	.	[] . [] . [] . []	.			\$2,814	\$2,709	\$2,773	\$2,864	\$2,816	\$3,108	550DT
[94/95]75	L	.	[] . [] . [] . []	.			\$2,944	\$2,839	\$2,925	\$3,042	\$3,039	\$3,302	940L
[94/95]75	L-BE	.	[] . [] . [] . []	.			\$2,944	\$2,839	\$2,925	\$3,042	\$3,039	\$3,302	940L-BE
[94/95]75	L-DT	.	[] . [] . [] . []	.			\$3,028	\$2,923	\$3,009	\$3,126	\$3,123	\$3,386	940L-DT
FIRE EXIT HARDWARE							3' AND 4' DEVICE PRICING SHOWN.						
[94/95]75	EO	. F	[] . []	.			\$2,546	\$2,441	\$2,505	\$2,589	\$2,672	\$2,822	N/A
[94/95]75	DT	. F	[] . []	.			\$3,138	\$3,033	\$3,097	\$3,188	\$3,140	\$3,432	550DT
[94/95]75	NL	. F	[] . [] . [] . []	.			\$3,138	\$3,033	\$3,097	\$3,188	\$3,140	\$3,432	550DT
[94/95]75	L	. F	[] . [] . [] . []	.			\$3,268	\$3,163	\$3,249	\$3,366	\$3,363	\$3,626	940L
[94/95]75	L-BE	. F	[] . [] . [] . []	.			\$3,268	\$3,163	\$3,249	\$3,366	\$3,363	\$3,626	940L-BE

DEFAULT ATTRIBUTES

Pricing includes default options shown below. Additional options and configurations available.

Cylinders:	Sex bolts	Door thickness	Center line
Not included	Not included	1-3/4"	39-13/16"

Strike(s):

Exit hardware:

- Includes 575 strike

Fire exit hardware:

- Includes 575 strike

OPTIONS

605	606	611	612	613	619	622	625	626	626AM	628	629
US3	US4	US9	US10	US10B	US15	US19	US26	US26D	US26DAM	US28	US32
630	630AM	643e	689	691	693	695	706	710	711	721	728
US32D	US32DAM	-	SP28	SP10	SPBLK	SP313	SP4	313	315	US3A	US4A

DEVICE LENGTH	Specify (Prefix)	Price adjustment
2' 6" up to 2' 9.7/8" Door	2' 6" up to 2' 9.7/8" Door	\$148.00

LESS BOTTOM ROD (LBR/LBL Fire-Rated Devices must be ordered in pairs, and one Auxiliary Fire Pin (AFL) is furnished per pair.)	Specify (Suffix)	Price adjustment
94/9547-F LBR	LBR	\$0.00
94/9547 LBR	LBR	-\$133.00

ANTIMICROBIAL COATING - Available in 626 (US26D) and 630 (US32D), use suffix "AM" when ordering. Example: 626AM	Specify (Suffix)	Price adjustment
For device with or without trim	AM	\$73.00
For trim only (626AM)	AM	\$34.00

SWITCHES - Available on all 94/95 Series devices	Specify (Prefix)	Price adjustment
Latchbolt Monitoring	LX	\$266.00
Signal Switch - for 94/9575 mortise devices (includes SS7500IN lock), specify handing	SS	\$266.00

LATCH RETRACTION - See 94/95 product catalog for required accessory equipment	Specify (Prefix)	Price adjustment
Quiet electric latch retraction	QEL	\$979.00

ACCESSIBLE DEVICE	Specify (Prefix)	Price adjustment
<ul style="list-style-type: none"> Accessible device compliant with the California Building Code (Section 11B-309.4) requirement for 5 lb. maximum operational force Available on AX94/9547 and AX94/9547-F Trim functions available EO, DT, NL, L, LBE, LDT and LNL 	AX	\$67.00

KITS

QEL CONVERSION KITS - Field conversion kits for Quiet Electric Latch Retraction	Specify	Price each
Modular conversion kits (for non-EL panic devices, for non-EL fire-rated devices sold after October 2014, or for replacing existing motor)	Standard	
	3' or 4' device	
QEL modular conversion kit	958005-00	\$979.00
LBR KIT	Specify	Price each
Fire Pin Kit, complete auxiliary bolt field replacement kit	051860-32	\$162.00

PARTS AND ACCESSORIES

605	606	611	612	613	619	622	625	626	626AM	628	629
US3	US4	US9	US10	US10B	US15	US19	US26	US26D	US26DAM	US28	US32
630	630AM	643e	689	691	693	695	706	710	711	721	728
US32D	US32DAM	-	SP28	SP10	SPBLK	SP313	SP4	313	315	US3A	US4A

CENTER CASE

Description	Specify		Non-Finished	622	628	626	710	612	606	605, 625
	Part number	Finish								
94/9547/48/75 Center Case	CASE.107	-	\$253.00	-	-	-	-	-	-	-
Control Link Pin Kit (w/Retaining Ring)	050585	-	\$13.00	-	-	-	-	-	-	-
Retaining Ring Pkg/10	090107	-	\$14.00	-	-	-	-	-	-	-
Main Control Link	971712	-	\$17.00	-	-	-	-	-	-	-

MECHANISM CASE

Description	Specify		Non-Finished	622	628	626	710	612	606	605, 625
	Part number	Finish								
94/9547/48/75 End Cap Package	ECAP.115	.[Finish]	-	\$104.00	-	-	-	-	-	-
INPACT Device Mounting Package	PKGMTG.1001	-	\$34.00	-	-	-	-	-	-	-
9547/48/75-F Pushpad	971655	.[Finish]	-	-	-	-	-	-	-	\$345.00
9447/48/75-F Pushpad	971656	.[Finish]	-	-	-	-	-	-	-	\$345.00
Dogging Clip	971659	-	\$40.00	-	-	-	-	-	-	-
Dogging Clip Spring	971664	-	\$14.00	-	-	-	-	-	-	-
9547/48/75 Pushpad	971763	.[Finish]	-	-	\$259.00	\$292.00	\$279.00	\$321.00	\$309.00	-
9447/48/75 Pushpad	971764	.[Finish]	-	-	\$259.00	\$292.00	\$279.00	\$321.00	\$309.00	-
9547/48-F/75-F Pushpad	971765	.[Finish]	-	-	\$259.00	\$292.00	\$279.00	\$321.00	\$309.00	-
9447/48-F/75-F Pushpad	971766	.[Finish]	-	-	\$259.00	\$292.00	\$279.00	\$321.00	\$309.00	-
Baseplate Link Pin	971706	-	\$17.00	-	-	-	-	-	-	-
9547/48/75 Pushpad	971709	.[Finish]	-	-	-	-	-	-	-	\$345.00
9447/48/75 Pushpad	971710	.[Finish]	-	-	-	-	-	-	-	\$345.00
94/95 EL Kit Hardware	900626	.[Finish]	\$41.00	-	-	-	-	-	-	-
94/95 Dogging Bracket Assembly	BRKT.131	.[Finish]	\$58.00	-	-	-	-	-	-	-

VERTICAL ROD AND LATCHES

Description	Specify		Non-Finished	628	710	612	606
	Part number	Finish					
94/9547/-F Rod Adjustment Kit	KIT.1001	-	\$32.00	-	-	-	-
94/9547/-F Rod Adj. Kit - LBR	KIT.1002	-	\$22.00	-	-	-	-
94/9547/-F Top Rod Kit	RODASY.121	-	\$99.00	-	-	-	-
94/9547/-F Bottom Rod Kit	RODASY.122	-	\$99.00	-	-	-	-
94/9547/-F Extension Rod Kit	051808	-	\$31.00	-	-	-	-
94/9547/-F Top Latch Kit	050492	-	\$302.00	-	-	-	-
94/9547/-F Bottom Latch Kit	050493	-	\$245.00	-	-	-	-
94/9547/-F Ratchet Release Kit	106222	.[Finish]	-	\$146.00	\$146.00	\$146.00	\$146.00
94/9547/-F Latch Mtg. Bracket Kit	109324	-	\$60.00	-	-	-	-

2670 GUARD-X SERIES

605	606	611	612	613	619	622	625	626	626AM	628	629
US3	US4	US9	US10	US10B	US15	US19	US26	US26D	US26DAM	US28	US32
630	630AM	643e	689	691	693	695	706	710	711	721	728
US32D	US32DAM	-	SP28	SP10	SPBLK	SP313	SP4	313	315	US3A	US4A

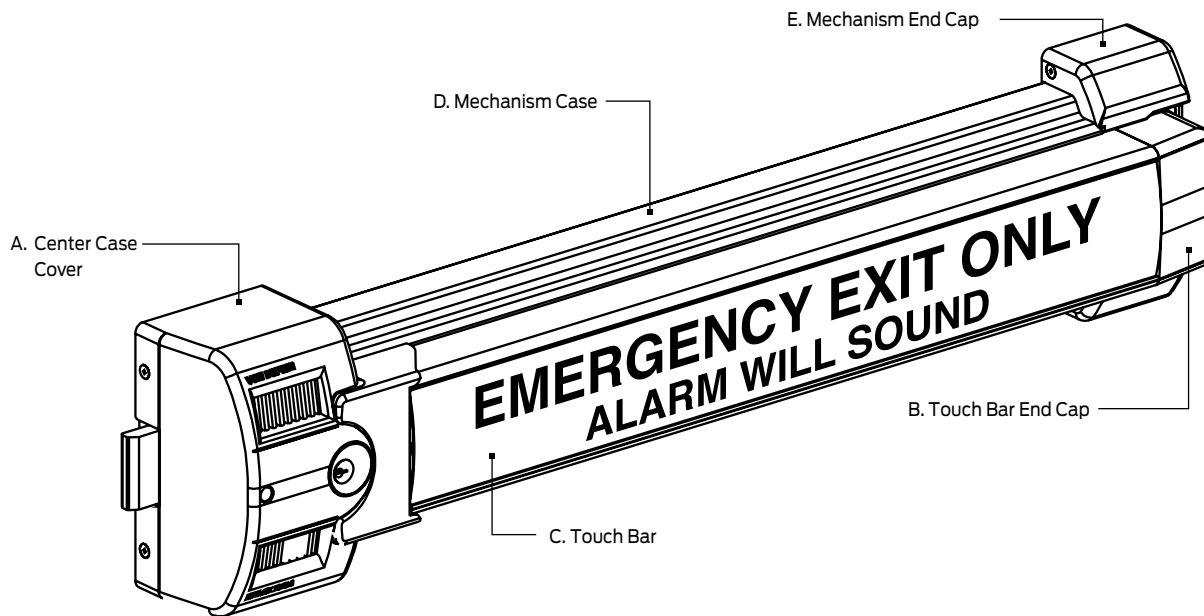

STANDARD FINISHES						
COLOR	US NUMBER	BHMA NUMBER	A	B, E	C - TOUCH BAR FINISHES	D
Anodized Aluminum	US28	628	Powder Coat	Plastic - Silver	Satin Stainless Steel US32D, 630	Anodized
Duranodic Dark Bronze	313	710	Powder Coat	Plastic - Brown	Duranodic Dark Bronze 313, 710	Powder Coat
Black	315	711	Powder Coat	Plastic - Black	Black 315, 711	Powder Coat

2670 SERIES SEX BOLT QUANTITIES	
APPLICATION	SEX BOLT 325 (OPTIONAL)
Aluminum Door	6

2670 GUARD-X SERIES

605	606	611	612	613	619	622	625	626	626AM	628	629
US3	US4	US9	US10	US10B	US15	US19	US26	US26D	US26DAM	US28	US32
630	630AM	643e	689	691	693	695	706	710	711	721	728
US32D	US32DAM	-	SP28	SP10	SPBLK	SP313	SP4	313	315	US3A	US4A

TYPE OF DEVICE

2670
GUARD-X

DEVICE FINISH

628: Anodized Aluminum (US28) 710: Duranodic Dark Bronze (313) 711: Black (315)

DEVICE LENGTH (FEET AND INCHES)

36" to 48" Door Width

DEVICE HANDING

RHR: Right Hand Reverse LHR: Left Hand Reverse

TRIM OPTIONS

LT: Less Trim 210DT: Dummy Pull Trim 230DT: Dummy Pull Trim

TRIM FINISH

689: Painted Aluminum (SP28) 695: Painted Dark Bronze (SP313)

STRIKE SERIES

LS: Less Strike 267: Standard 2609: Double Door Strike

STRIKE FINISH

622: Matte Black (US19)

PUSHPAD OPTIONS

ENG: English with Braille Standard FR: French SP: Spanish

MISC DEVICE OPTIONS

SNB: Include # of Sex Bolts CYL: 3216 Rim Cylinder

DOOR THICKNESS

DT1-3/4: 1-3/4" Standard

2670 GUARD-X SERIES

605	606	611	612	613	619	622	625	626	626AM	628	629
US3	US4	US9	US10	US10B	US15	US19	US26	US26D	US26DAM	US28	US32
630	630AM	643e	689	691	693	695	706	710	711	721	728
US32D	US32DAM	-	SP28	SPI0	SPBLK	SP313	SP4	313	315	US3A	US4A

DEVICE					
Description	Specify		628	710	711
	Model number	Finish			
36" to 48" Door Width	2670	.[Finish]	\$672.00	\$672.00	\$672.00

Note: Pushpad Sign furnished in English with Braille standard. French and Spanish language available at no additional charge.

DEFAULT ATTRIBUTES

Pricing includes default options shown below. Additional options and configurations available.

Cylinders:	Sex bolts	Battery	Screw pack
Not included	Not included	Included	Included

Strike(s): Exit hardware:
 ■ Includes 267 strike

PARTS AND ACCESSORIES

GUARD-X 26 SERIES					
Description	Specify		Non-Finished	711, 622	689, 695
	Part number	Finish			
2670 Lockside Cover Kit SP28	COVER.109	.[Finish]	-	-	\$201.00
2670 Lockside Cover Kit US19	COVER.122	.[Finish]	-	\$201.00	-
2670 Lockside Cover Kit SP313	COVER.121	.[Finish]	-	-	\$201.00
2670 Hingeside Cover Kit - Silver	COVER.114	.[Finish]	-	-	\$51.00
2670 Hingeside Cover Kit - Black	COVER.115	.[Finish]	-	\$51.00	-
2670 Hingeside Cover Kit - Brown	COVER.116	.[Finish]	-	-	\$51.00
2670 Endcap Kit	ECAP.105	.[Finish]	-	\$30.00	-
2670 PCB Kit Field - English	PCB.10018	-	\$271.00	-	-
2670 PCB Kit Field - Spanish	PCB.10019	-	\$271.00	-	-
2670 PCB Kit Field - French	PCB.10020	-	\$271.00	-	-
Alarm Sign - French	SIGN.1001	-	\$70.00	-	-
Alarm Sign - Spanish	SIGN.1002	-	\$70.00	-	-
Alarm Sign - English	SIGN.1003	-	\$70.00	-	-
Cylinder Retaining Bracket Kit	BRKT.121	-	\$40.00	-	-
Lightpipe Kit	PIPE.101	-	\$31.00	-	-
2670 Cylinder Tailpiece Extension	050379	-	\$12.00	-	-
2670 Device Mounting Package US28	PKGMTG.1002	.[Finish]	-	-	\$34.00
2670 Device Mounting Package Black	PKGMTG.1003	.[Finish]	-	\$34.00	-
2670 Cover Screw Kit SP28	PKGSCR.1001	-	\$12.00	-	-

ACCESSORIES							
Description	Specify		622	689	695	626	613
	Model number	Finish					
9-Volt External Power Supply	PT970	-	\$194.00	-	-	-	-
Dummy Pull Trim and Screw Pack	210DT x 050140	.[Finish]	-	\$72.00	\$72.00	-	-
Dummy Pull Trim and Screw Pack	230DT x 050140	.[Finish]	-	\$129.00	\$129.00	-	-
Rim Cylinder	3216	.[Finish]	-	-	-	\$96.00	\$96.00
Double Door Strike	2609	-	\$119.00	-	-	-	-
267 Strike Pkg	267	-	\$40.00	-	-	-	-

ACCESSORIES AND PARTS

22 SERIES
33A/35A SERIES
55 SERIES
88 SERIES
98/99 SERIES
XP98/XP99 SERIES
94/95 SERIES
GUARD-X SERIES
ACCESSORIES / PARTS
ELECTRICAL / PARTS

DUMMY CROSS/TOUCH BARS

605	606	611	612	613	619	622	625	626	626AM	628	629
US3	US4	US9	US10	US10B	US15	US19	US26	US26D	US26DAM	US28	US32
630	630AM	643e	689	691	693	695	706	710	711	721	728
US32D	US32DAM	-	SP28	SP10	SPBLK	SP313	SP4	313	315	US3A	US4A

DUMMY CROSS BARS - 4' DUMMY CROSS BAR PRICED COMPLETE WITH SEX BOLTS.

Description	Specify		626	613	612	606	605, 625, 643e, 693
	Model number	Finish					
55 Series device dummy crossbar, 4'	55DU	[Finish]	\$1,980.00	\$1,980.00	\$2,301.00	\$1,868.00	\$2,448.00
88 Series device dummy crossbar, 4'	88DU	[Finish]	\$999.00	\$999.00	\$1,041.00	\$842.00	\$1,165.00

DUMMY TOUCH BARS - 3' DUMMY TOUCH BAR PRICED COMPLETE WITH SEX BOLTS. 4' ADD \$19.00 LIST

Description	Specify		626	628	630 ¹	710	606 612	605 625 643e	711	619
	Model number	Finish								
33A/99 Series device dummy touch bar	330	[Finish]	\$850.00	\$708.00	N/A	\$730.00	\$763.00	\$850.00	\$1,523.00	N/A
35A/98 Series device dummy touch bar	350	[Finish]	\$850.00	\$708.00	\$899.00	\$730.00	\$763.00	\$850.00	\$1,523.00	\$850.00

¹ 630 finish available with 350 model only.

Notes:

Back-to-back mounting - available on 330, 350 when used with outside trim. Finished fasteners supplied at \$17.00 list add.
Antimicrobial coating - available in 626AM and 630AM (350 Series only) finishes, \$73.00 list add.

OPTIONS

SWITCH OPTIONS	Specify (Prefix)	Price adjustment
Request to Exit Switch. Available for 330, 350, 55DU, 88DU.	RX	\$266.00
Double RX - Request to Exit Switch. Available for 330, 350.	RX-2	\$331.00
Waterproof Request to Exit - Available for 330, 350.	WP-RX	\$384.00
Convert existing RX switch to RX-2 switch. Order part number 050271-00. Available for 330, 350	RX-AUX	\$277.00
Signal Switch. Available for 330/350. Specify handing RHR or LHR.	SS	\$545.00

END CAP

Description	Specify		Non-Finished	628	626	710	612	606	605 619 ¹ 625 711
	Part number	Finish							
330/350 End Cap Kit for Lock Stile	050014	[Finish]	-	\$86.00	\$96.00	\$86.00	\$107.00	\$97.00	\$97.00
RX330/350 End Cap Mtg Bracket for Lock Stile	050524	-	\$12.00	-	-	-	-	-	-

STRIKES

605	606	611	612	613	619	622	625	626	626AM	628	629
US3	US4	US9	US10	US10B	US15	US19	US26	US26D	US26DAM	US28	US32
630	630AM	643e	689	691	693	695	706	710	711	721	728
US32D	US32DAM	-	SP28	SP10	SPBLK	SP313	SP4	313	315	US3A	US4A

RIM STRIKES											
Description	Specify		Standard		Optional						
	Model number	Finish	Non finished	622	626	630	606, 612, 613	605	625	629	689 695
22/88/98/99, 98/9957 Panic - Optional	264	.[Finish]	-	\$108.00	\$126.00	-	-	-	-	-	-
88 Fire - Standard	268	.[Finish]	-	\$134.00	-	\$157.00	\$179.00	\$188.00	-	\$188.00	-
22/88/98/99, 98/9957 Panic - Standard	299	.[Finish]	-	\$66.00	\$78.00	-	\$78.00	\$102.00	\$102.00	-	-
22/98/99 Fire, 98/9957 Fire - Standard	299F	.[Finish]	-	\$82.00	-	\$109.00	\$128.00	\$147.00		\$147.00	
HH-9954 Mullion	468	.[Finish]	-	\$112.00	-	-	-	-	-	-	-
22/98/99 Fire w/9954 Mullion - Standard	499F	.[Finish]	-	\$194.00	-	\$204.00	-	-	-	-	-
Panic w/5754 Mullion - Standard	1408	-	\$293.00	-	-	-	-	-	-	-	-
55 Panic - Standard/22 - Optional	1409	-	\$157.00	-	-	-	-	-	-	-	-
Panic, Integral Stop - Optional	1410	-	\$157.00	-	-	-	-	-	-	-	-
33A/35A Panic - Standard/22 - Optional	1439	.[Finish]	-	\$157.00	-	-	-	-	-	-	-
33A/35A-F - Optional	1439F	.[Finish]	-	\$164.00	-	-	-	-	-	-	-
Panic, Sgl or Pr w/1654 Mullion - Optional	1606	-	\$78.00	-	-	-	-	-	-	-	-
Panic - Optional ¹	1609	.[Finish]	-	\$108.00	\$121.00	-	\$121.00	\$131.00	\$131.00	-	-
88 Panic, Stock HM Doors - Optiona ¹	1610	.[Finish]	-	\$108.00	\$121.00	-	\$121.00	\$131.00	\$131.00	-	-
98/9952 Roller Strike	699	.[Finish]	-	\$123.00	-	-	-	-	-	-	\$123.00
2670 GUARD-X - Standard	267	.[Finish]	-	\$40.00	-	-	-	-	-	-	-
2670 GUARD-X, Pairs - Optional	2609	.[Finish]	-	\$119.00	-	-	-	-	-	-	-
XP98/99 - Standard	909	.[Finish]	-	\$82.00	-	-	-	-	-	-	-
XP98/99 Mullion - Optional	954	.[Finish]	-	\$194.00	-	-	-	-	-	-	-
299F Strike Adapter	050996-622	.[Finish]	-	\$174.00	-	-	-	-	-	-	-

¹ 1609 and 1610 must be used with coordinator. Not a UL Fire Exit Hardware listed application.

VERTICAL ROD TOP STRIKES											
Description	Specify		Standard		Optional						
	Model number	Finish	Non finished	622	626	630	606, 612, 613	605	625	629	689 695
33/3550AWDC/98/9950WDC includes shims and fasteners	150	-	\$46.00	-	-	-	-	-	-	-	-
33/3549A/98/9949 includes shims and fasteners	249	-	\$47.00	-	-	-	-	-	-	-	-
22/33A/35A/88/98/9927/57 Panic, Flush Transom	260U	.[Finish]	-	\$108.00	\$121.00	-	\$121.00	\$147.00	\$147.00	-	-
22/33A/88/98/9927/57 Fire Flush Transom	260U-F	.[Finish]	-	-	-	\$301.00	-	-	-	-	-
22/33A/35A/88/98/9927/57 Panic - Optional	264	.[Finish]	-	\$108.00	\$126.00	-	-	-	-	-	-
33/3527A Panic - Standard	266	.[Finish]	-	\$121.00	-	\$134.00	\$152.00	\$172.00	-	\$172.00	-

Z2 SERIES
 33A/35A SERIES
 55 SERIES
 88 SERIES
 98/99 SERIES
 XP98/XP99 SERIES
 94/95 SERIES
 GUARD-X SERIES
 ACCESSORIES / PARTS
 ELECTRICAL / PARTS

STRIKES

605	606	611	612	613	619	622	625	626	626AM	628	629
US3	US4	US9	US10	US10B	US15	US19	US26	US26D	US26DAM	US28	US32
630	630AM	643e	689	691	693	695	706	710	711	721	728
US32D	US32DAM	-	SP28	SP10	SPBLK	SP313	SP4	313	315	US3A	US4A

VERTICAL ROD TOP STRIKES

Description	Specify		Standard		Optional						
	Model number	Finish	Non finished	622	626	630	606, 612, 613	605	625	629	689 695
33A/35A/98/9947WDC, Wood Frames - specify door thickness	283	-	\$69.00	-	-	-	-	-	-	-	-
22/88/98/9927/57 Panic - Standard	299	.[Finish]	-	\$66.00	\$78.00	-	\$78.00	\$102.00	\$102.00	-	-
22/98/9927 Fire - Standard	299F	.[Finish]	-	\$82.00	-	\$109.00	\$128.00	\$147.00	-	\$147.00	-
33A/35A/98/9947 and WDC - Standard	338	-	\$69.00	-	-	-	-	-	-	-	-
33/3527A/98/9927 LBR Fire, Pairs - Standard	499F	.[Finish]	-	\$194.00	-	\$204.00	-	-	-	-	-
5547 Panic, HM Frame - Standard	471U	-	\$66.00	-	-	-	-	-	-	-	-
5547WDC, 1-3/4" Dr, WD Frame - Standard	472U	.[Finish]	-	\$66.00	\$68.00	-	\$70.00	\$90.00	\$90.00	-	-
5547WDC, 2-1/4" Dr, WD Frame - Standard	473U	.[Finish]	-	\$66.00	\$68.00	-	\$70.00	\$90.00	\$90.00	-	-

VERTICAL ROD BOTTOM STRIKES

Description	Specify		Standard		Optional						
	Model number	Finish	Non finished	622	626	630	606 612	605	625	629	689 695
22/33A/35A/98/9927, 98/9957 Panic - Standard	248L-4	-	\$62.00	-	-	-	-	-	-	-	-
55/8847 Fire - Standard	301L	-	\$142.00	-	-	-	-	-	-	-	-
22/33A/35A/98/9927, 98/9957 - Standard	304L	-	\$62.00	-	-	-	-	-	-	-	-
33/3594A/98/9949 includes anchors and fasteners	349	-	\$27.00	-	-	-	-	-	-	-	-
33A/35A/98/9947/48 and WDC - Standard ¹	385A	-	\$133.00	-	-	-	-	-	-	-	-
33/3550AWDC/98/9950WDC includes anchor and fasteners	450	-	\$26.00	-	-	-	-	-	-	-	-

¹ The 385A is recommended over the 304L for wood door applications based on it's adjustability.

MORTISE LOCK STRIKES

Description	Specify		Standard		Optional						
	Model number	Finish	Non finished	622	626	630	606, 612, 613	605	625	629	689 695
55/88/98/9975 - Standard	575	-	\$49.00	-	-	\$69.00	\$131.00	\$149.00	-	\$149.00	-
55/88/99/9875, Pairs 1-3/4" Dr - Optional	575-2	-	\$49.00	-	-	\$69.00	\$131.00	\$149.00	-	\$149.00	-
55/88/98/9975, Pairs 1-3/4" Dr - Optional	576A	-	\$134.00	-	-	\$142.00	\$161.00	\$178.00	-	\$178.00	-
55/88/99/9875, Pairs 2-1/4" Dr - Optional	576B	-	\$134.00	-	-	\$142.00	\$161.00	\$178.00	-	\$178.00	-

TRIMS

605	606	611	612	613	619	622	625	626	626AM	628	629
US3	US4	US9	US10	US10B	US15	US19	US26	US26D	US26DAM	US28	US32
630	630AM	643e	689	691	693	695	706	710	711	721	728
US32D	US32DAM	-	SP28	SP10	SPBLK	SP313	SP4	313	315	US3A	US4A

22 SERIES

22 SERIES TRIM				
Description	Specify		689	626
	Model number	Finish	695	613
STANDARD:				
Dummy Trim	210DT	-	\$55.00	-
Night Latch	210NL	-	\$63.00	-
Knob	210K	-	\$249.00	-
Lever	230L	-	\$244.00	-
Thumbpiece	230TP	-	\$243.00	-
OPTIONAL:				
Knob, Blank Escutcheon	210K-BE	-	\$249.00	-
Exit Only Trim Plate	230EO	-	\$102.00	-
Dummy Trim	230DT	-	\$112.00	-
Night Latch	230NL	-	\$124.00	-
Lever, Blank Escutcheon	230L-BE	-	\$244.00	-
Thumbpiece, Blank Escutcheon	230TP-BE	-	\$243.00	-
Night Latch Cylinder Assembly - HM Door	110MD-NL	.[Finish]	-	\$140.00
Night Latch Cylinder Assembly - WD Door	110WD-NL	.[Finish]	-	\$140.00

33A/35A SERIES

33A/35A SERIES TRIM - STANDARD							
Description	Specify		626	693	612	606	605, 619,
	Model number	Finish		613			625, 643e
Dummy Trim	386DT	-	\$369.00	\$369.00	\$517.00	\$369.00	\$460.00
Night Latch - Specify handing	386NL	-	\$656.00	\$656.00	\$804.00	\$656.00	\$747.00
Night Latch Cylinder Trim	388	-	\$323.00	\$323.00	\$465.00	\$302.00	\$323.00

33A/35A SERIES TRIM - OPTIONAL							
Description	Specify		626	613	612	606	605, 693,
	Model number	Finish					625, 643e
Dummy Trim - only available with 388 cyl. trim (Rim only)	550DT	-	\$592.00	\$592.00	\$599.00	\$468.00	\$610.00
Dummy Offset Pull	392-6	-	\$228.00	-	-	-	-

Note: Antimicrobial coating - available in 626AM finish, \$34.00 list add.

For other possible trim applications not shown, consult Von Duprin.

ELECTRICAL / PARTS ACCESSORIES / PARTS GUARD-X SERIES 94/95 SERIES 98/99 SERIES 88 SERIES 55 SERIES 33A/35A SERIES 22 SERIES

TRIMS

605	606	611	612	613	619	622	625	626	626AM	628	629
US3	US4	US9	US10	US10B	US15	US19	US26	US26D	US26DAM	US28	US32
630	630AM	643e	689	691	693	695	706	710	711	721	728
US32D	US32DAM	-	SP28	SP10	SPBLK	SP313	SP4	313	315	US3A	US4A

55 SERIES

55 SERIES TRIM								
Description	Specify			626	613	612	606	605, 625, 693, 643e
	Model number	Finish						
STANDARD:								
Dummy Trim	550DT	.[Finish]		\$592.00	\$592.00	\$599.00	\$468.00	\$610.00
Night Latch Trim - HM Door	555NL	.[Finish]		\$779.00	\$779.00	\$786.00	\$655.00	\$797.00
Night Latch Trim - WD Door	556NL	.[Finish]		\$779.00	\$779.00	\$786.00	\$655.00	\$797.00
Dummy Trim	609DT	.[Finish]		\$403.00	\$403.00	\$403.00	\$311.00	\$446.00
Night Latch Cylinder Assembly - HM Door	110MD-NL	.[Finish]		\$140.00	\$140.00	\$140.00	\$130.00	\$140.00
Night Latch Cylinder Assembly - WD Door	110WD-NL	.[Finish]		\$140.00	\$140.00	\$140.00	\$130.00	\$140.00
Night Latch Cylinder Assembly - HM Door	555NL-CA	.[Finish]		\$385.00	\$385.00	\$385.00	\$324.00	\$385.00
Night Latch Cylinder Assembly - WD Door	556NL-CA	.[Finish]		\$385.00	\$385.00	\$385.00	\$324.00	\$385.00

88 SERIES

88 SERIES TRIM - SPECIFY DEVICE TYPE WHEN ORDERING (EXAMPLE: 880TP-V)								
Description	Specify			626	613	612	606	605, 625, 693, 643e
	Model number	Device type	Finish					
STANDARD:								
Exit Only Trim Plate	880EO ¹	[R or V&M]	.[Finish]	\$216.00	\$228.00	\$261.00	\$155.00	\$266.00
Dummy Trim	880DT	[R, V&M or V-SA]	.[Finish]	\$279.00	\$299.00	\$362.00	\$215.00	\$362.00
Night Latch	880NL	[R or M]	.[Finish]	\$297.00	\$317.00	\$380.00	\$233.00	\$380.00
Thumbpiece	880TP	[R, V, or M]	.[Finish]	\$311.00	\$331.00	\$434.00	\$296.00	\$434.00
Thumbpiece, Blank Escutcheon	880TP-BE	[R, V, or M]	.[Finish]	\$311.00	\$331.00	\$434.00	\$296.00	\$434.00
Knob	880K	[R, V, or M]	.[Finish]	\$363.00	\$389.00	\$461.00	\$296.00	\$461.00
Knob, Blank Escutcheon	880K-BE	[R, V, or M]	.[Finish]	\$363.00	\$389.00	\$461.00	\$296.00	\$461.00
Knob, Dummy	880K-DT	[R, V, or M]	.[Finish]	\$363.00	\$389.00	\$461.00	\$296.00	\$461.00
Knob, Night Latch	880K-NL	[R only]	.[Finish]	\$363.00	\$389.00	\$461.00	\$296.00	\$461.00
OPTIONAL:								
Dummy Trim	608DT	-	.[Finish]	\$403.00	\$403.00	\$403.00	\$311.00	\$446.00
Night Latch	608NL	[R or M]	.[Finish]	\$409.00	\$409.00	\$409.00	\$312.00	\$447.00
Thumbpiece	608TP	[R, V or M]	.[Finish]	\$440.00	\$412.00	\$440.00	\$335.00	\$510.00
Thumbpiece, Blank Escutcheon	608TP-BE	[R or M&V]	.[Finish]	\$440.00	\$412.00	\$440.00	\$335.00	\$510.00
Knob	606K	-	.[Finish]	\$441.00	\$441.00	\$472.00	\$367.00	\$472.00
Knob, Blank Escutcheon	606K-BE	-	.[Finish]	\$441.00	\$441.00	\$472.00	\$367.00	\$472.00
Knob, Dummy	606K-DT	-	.[Finish]	\$441.00	\$441.00	\$472.00	\$367.00	\$472.00

¹ 880 Trim - when used with 88-F Rim devices on wood or composite doors use trim suffix "WDF" (no additional charge) ex. 880WDF-EO

For other possible trim applications not shown, consult Von Duprin.

TRIMS

98/99 SERIES

605	606	611	612	613	619	622	625	626	626AM	628	629
US3	US4	US9	US10	US10B	US15	US19	US26	US26D	US26DAM	US28	US32
630	630AM	643e	689	691	693	695	706	710	711	721	728
US32D	US32DAM	-	SP28	SP10	SPBLK	SP313	SP4	313	315	US3A	US4A

98/99 SERIES TRIM - SPECIFY DEVICE TYPE WHEN ORDERING (EXAMPLE: 990TP-R)

Description	Specify			626	695 613	622 ¹ , 693	612	606	605, 625, 693, 643e
	Model number	Device type	Finish						
STANDARD:									
Exit Only Trim Plate	990EO	-	.[Finish]	\$179.00	\$179.00	\$179.00	\$224.00	\$147.00	\$202.00
Exit Only with Cylinder Hole	990EO-w/CH	-	.[Finish]	\$203.00	\$203.00	\$203.00	\$248.00	\$171.00	\$226.00
Dummy Trim	990DT	-	.[Finish]	\$269.00	\$282.00	\$282.00	\$282.00	\$217.00	\$294.00
Night Latch	990NL	.[R/V or M]	.[Finish]	\$285.00	\$298.00	\$298.00	\$298.00	\$233.00	\$310.00
Thumbpiece	990TP	.[R/V or M]	.[Finish]	\$387.00	\$398.00	\$398.00	\$387.00	\$322.00	\$416.00
Thumbpiece, Blank Escutcheon	990TP-BE	.[R/V or M]	.[Finish]	\$387.00	\$398.00	\$398.00	\$387.00	\$322.00	\$416.00
Knob	996K	.[R/V or M]	.[Finish]	\$476.00	\$476.00	\$476.00	\$540.00	\$400.00	\$575.00
Knob, Blank Escutcheon	996K-BE	.[R/V or M]	.[Finish]	\$476.00	\$476.00	\$476.00	\$540.00	\$400.00	\$575.00
Knob, Dummy	996K-DT	-	.[Finish]	\$466.00	\$466.00	\$466.00	\$530.00	\$390.00	\$565.00
Knob, Night Latch	996K-NL	.[R/V or M]	.[Finish]	\$466.00	\$466.00	\$466.00	\$530.00	\$390.00	\$565.00
Night Latch Cyl. Assy, MD Dr	110MD-NL	-	.[Finish]	\$140.00	\$140.00	\$140.00	\$140.00	\$130.00	\$140.00
Night Latch Cyl. Assy, WD Dr	110WD-NL	-	.[Finish]	\$140.00	\$140.00	\$140.00	\$140.00	\$130.00	\$140.00
OPTIONAL:									
Dummy Trim	696DT ²	-	.[Finish]	\$410.00	\$410.00	\$410.00	\$410.00	\$318.00	\$453.00
Night Latch	696NL ²	.[R/V or M]	.[Finish]	\$454.00	\$454.00	\$454.00	\$454.00	\$357.00	\$492.00
Thumbpiece	696TP ²	.[R/V or M]	.[Finish]	\$508.00	\$480.00	\$508.00	\$508.00	\$403.00	\$578.00
Thumbpiece, Blank Escutcheon	696TP-BE ²	.[R/V or M]	.[Finish]	\$508.00	\$480.00	\$508.00	\$508.00	\$403.00	\$578.00
Dummy Trim	697DT ²	-	.[Finish]	\$410.00	\$410.00	\$410.00	\$410.00	\$318.00	\$453.00
Night Latch	697NL ²	.[R/V or M]	.[Finish]	\$454.00	\$454.00	\$454.00	\$454.00	\$357.00	\$492.00
Thumbpiece	697TP ²	.[R/V or M]	.[Finish]	\$508.00	\$480.00	\$508.00	\$508.00	\$403.00	\$578.00
Thumbpiece, Blank Escutcheon	697TP-BE ²	.[R/V or M]	.[Finish]	\$508.00	\$480.00	\$508.00	\$508.00	\$403.00	\$578.00
Exit Only Trim Plate	996EO ²	.[R/V or M]	.[Finish]	\$357.00	\$357.00	\$357.00	\$423.00	\$342.00	\$423.00
Dummy Wire Pull	392-7 ²	-	.[Finish]	\$249.00	-	-	-	-	-

¹ 622 available on 996, 696 and 697 trims.

² Wood or Composite Fire Labeled Doors - when using 696/697 trims with 98/99-F Rim Fire devices use trim suffix "WDF", ex. 696WDF. No additional charge.

OPTIONS

ANTIMICROBIAL FINISH	Specify (Prefix)	Price adjustment
Antimicrobial Coating available in 626, use suffix-AM when ordering. Example 626AM	AM	\$34.00

DOOR THICKNESS >2-1/4" - 4 1/4"	Specify (Prefix)	Price adjustment
110NL-MD or 110NL-WD	Door Thickness > 2-1/4" - <= 4 1/4"	\$96.00

For other possible trim applications not shown, consult Von Duprin.

TRIMS

605	606	611	612	613	619	622	625	626	626AM	628	629
US3	US4	US9	US10	US10B	US15	US19	US26	US26D	US26DAM	US28	US32
630	630AM	643e	689	691	693	695	706	710	711	721	728
US32D	US32DAM	-	SP28	SP10	SPBLK	SP313	SP4	313	315	US3A	US4A

98/99 SERIES

98/99 SERIES TRIM - SPECIFY DEVICE TYPE WHEN ORDERING (EXAMPLE: 996L-R)

Description	Specify			626	629 ¹ 630 ¹	695 613	622 693	612	606	605, 619, 625, 643e
	Model number	Device type	Finish							
LEVER TRIM WITH STANDARD LEVER DESIGNS										
Lever	996L	.[R/V or M]	.[Finish]	\$619.00	\$725.00	\$641.00	\$641.00	\$674.00	\$588.00	\$701.00
Lever, Blank Escutcheon	996L-BE	.[R/V or M]	.[Finish]	\$619.00	\$725.00	\$641.00	\$641.00	\$674.00	\$588.00	\$701.00
Lever, Dummy	996L-DT	-	.[Finish]	\$493.00	\$599.00	\$515.00	\$515.00	\$548.00	\$462.00	\$575.00
Lever, Night Latch	996L-NL	.[R/V or M]	.[Finish]	\$493.00	\$599.00	\$515.00	\$515.00	\$548.00	\$462.00	\$575.00
LEVER TRIM WITH M COLLECTION LEVER DESIGNS										
Lever	996L	.[R/V or M]	.[Finish]	\$745.00	\$745.00	\$745.00	\$745.00	\$745.00	\$725.00	\$745.00
Lever, Blank Escutcheon	996L-BE	.[R/V or M]	.[Finish]	\$745.00	\$745.00	\$745.00	\$745.00	\$745.00	\$725.00	\$745.00
Lever, Dummy	996L-DT	-	.[Finish]	\$619.00	\$619.00	\$619.00	\$619.00	\$619.00	\$599.00	\$619.00
Lever, Night Latch	996L-NL	.[R/V or M]	.[Finish]	\$619.00	\$619.00	\$619.00	\$619.00	\$619.00	\$599.00	\$619.00

¹ 630 lever furnished with 619 trim plate. 629 lever furnished with 625 trim plate. Please see stainless steel lever designs below.

OPTIONS

LEVER DESIGNS

Standard	<ul style="list-style-type: none"> 06 Lever Design - furnished standard Optional Lever Designs - 01, 02, 03, 05, 07, 12, 16, 17, 18, Accent (ACC), Asti (AST), Merano (MER), Latitude (LAT), Longitude (LON) Stainless Steel Levers - 03-SS, 06-SS, 17-SS, Latitude-SS (LAT-SS), Longitude-SS (LON-SS) are available in 629 or 630
M Collection	<ul style="list-style-type: none"> M51, M52, M53, M54, M55, M56, M57, M61, M62, M63, M81, M82, M83, M84, M85, ME1, ME2, ME3 Stainless Steel Levers - M57 and M62 lever designs available in stainless steel only
Handing	<ul style="list-style-type: none"> Field reversible and furnished RHR if not specified on all lever designs except 12, AST, MER, ACC, M61, M62, M63, M85 Specify handing RHR or LHR for lever designs 12, AST, MER, ACC, M61, M62, M63, M85, ME1, ME2

KNURLED LEVER

	Specify (Suffix)	Price adjustment
Available standard on 02, 03, 06, 07, 17, ME1, ME2, and ME3 lever designs. Specify suffix KN (06-KN)	KN	\$112.00
Available for special order on M51, M52, and M81 lever designs. Specify suffix KN (M51-KN)		\$171.00

ANTIMICROBIAL FINISH

	Specify (Suffix)	Price adjustment
Antimicrobial Coating available in 626, use suffix-AM when ordering. Example 626AM	AM	\$34.00

ELECTRIC UNLOCKING

	Specify (Prefix)	Price adjustment
Motor Driven Electric Unlocking of outside M996 Trim - for 98/99 rim, mortise, surface vertical and concealed vertical devices. Available with L or LBE functions only. Specify handing. Dual voltage - works with either 12 or 24 VDC power supplies, furnished Fail Safe (FS) but can be converted in the field with dip switch without mechanical conversion. See page 142 for pricing and optional lever designs.	M996	\$666.00

SWITCH

	Specify (Prefix)	Price adjustment
Request to exit 996L option available for use with 98/99 rim, mortise, surface and concealed devices. Specify trim "RX996"	RX	\$266.00

CONNECTORS

	Specify (Suffix)	Price adjustment
Cross-category solution using common interconnect components for electrified options. Available with M996 trim.	CON	\$0.00

For other possible trim applications not shown, consult Von Duprin.

TRIMS

605	606	611	612	613	619	622	625	626	626AM	628	629
US3	US4	US9	US10	US10B	US15	US19	US26	US26D	US26DAM	US28	US32
630	630AM	643e	689	691	693	695	706	710	711	721	728
US32D	US32DAM	-	SP28	SP10	SPBLK	SP313	SP4	313	315	US3A	US4A

QUIET MECHANICAL	Specify (Prefix)	Price adjustment
Controls motion to reduce operational noise. The QM trim option provides damper-controlled lever return. Available on 996L/LBE - R/V/M. Not available with M996 and RX996.	QM	\$199.00

KITS

ELECTRICAL UNLOCKING RETROFIT KITS	Specify	Price each
996 R/V/C Conversion to M996 Motorized Kit	47273111	\$740.00
996 Mort Conversion to M996 Motorized Kit	47273112	\$770.00

94/95 SERIES

94/95 SERIES CONTROLS							
Description	Specify		626	613, 695, 693	612	606	605, 625, 643e
	Model number	Finish					
STANDARD LEVER DESIGNS							
Lever	940L ¹	.[Finish]	\$722.00	\$744.00	\$777.00	\$691.00	\$804.00
Lever, Blank Escutcheon	940L-BE	.[Finish]	\$722.00	\$744.00	\$777.00	\$691.00	\$804.00
Lever, Dummy	940L-DT	.[Finish]	\$806.00	\$828.00	\$861.00	\$775.00	\$888.00
M COLLECTION LEVER DESIGNS							
Lever	940L ¹	.[Finish]	\$848.00	\$848.00	\$848.00	\$828.00	\$848.00
Lever, Blank Escutcheon	940L-BE	.[Finish]	\$848.00	\$848.00	\$848.00	\$828.00	\$848.00
Lever, Dummy	940L-DT	.[Finish]	\$932.00	\$932.00	\$932.00	\$912.00	\$932.00

¹ L-NL function is obtained with field conversion of L function.

OPTIONS

LEVER DESIGNS	
Standard	<ul style="list-style-type: none"> 06 Lever Design - furnished standard Optional Lever Designs - 01, 02, 03, 05, 07,12,16,17,18, Accent (ACC), Asti (AST), Merano (MER), Latitude (LAT), Longitude (LON) Stainless Steel Levers - 03-SS, 06-SS, 17-SS, Latitude-SS (LAT-SS), Longitude-SS (LON-SS) are available in 629 or 630 through special order.
M Collection	<ul style="list-style-type: none"> M51, M52, M53, M54, M55, M56, M57, M61, M62, M63, M81, M82, M83, M84, M85, ME1, ME2, ME3 Stainless Steel Levers - M57 and M62 lever designs available in stainless steel only
Handing	<ul style="list-style-type: none"> Field reversible and furnished RHR if not specified on all lever designs except 12, AST, MER, ACC, M61, M62, M63, M85 Specify handing RHR or LHR for lever designs 12, AST, MER, ACC, M61, M62, M63, M85, ME1, ME2

KNURLED LEVER	Specify (Suffix)	Price adjustment
Available standard on 02, 03, 06, 07, 17, ME1, ME2, and ME3 lever designs. Specify suffix KN (06-KN)	KN	\$112.00
Available for special order on M51, M52, and M81 lever designs. Specify suffix KN (M51-KN)		\$171.00

ANTIMICROBIAL FINISH	Specify (Suffix)	Price adjustment
Antimicrobial Coating available in 626, use suffix-AM when ordering. Example 626AM	AM	\$34.00

For other possible trim applications not shown, consult Von Duprin.

Z2 SERIES
33A/35A SERIES
55 SERIES
88 SERIES
98/99 SERIES
XP98/XP99 SERIES
94/95 SERIES
GUARD-X SERIES
ACCESSORIES / PARTS
ELECTRICAL / PARTS

PARTS AND ACCESSORIES

605	606	611	612	613	619	622	625	626	626AM	628	629
US3	US4	US9	US10	US10B	US15	US19	US26	US26D	US26DAM	US28	US32
630	630AM	643e	689	691	693	695	706	710	711	721	728
US32D	US32DAM	-	SP28	SPI0	SPBLK	SP313	SP4	313	315	US3A	US4A

210/230 SERIES TRIMS

Description	Specify		Non-finished	689 695
	Part number	Finish		
230DT x 330/350 Screw Package 1 3/4" Dr	050140	.[Finish]	—	\$17.00
230DT x 330/350 Screw Package 2 1/4" Dr	050141	.[Finish]	—	\$17.00
230L Cylinder Locknut	050526	-	\$15.00	—
210K Bracket & Booster Assembly	109871	-	\$70.00	—
210K Spiral Cam Sub-Assembly	109872	-	\$51.00	—
210K Cylinder Knob Sub-Assembly	109873	.[Finish]	—	\$130.00
210K Trim Sub-Assembly	109879	.[Finish]	—	\$132.00
210K Rose, Hub and Cap Assy	110343	.[Finish]	—	\$43.00
230L Tailpiece Auxiliary	900894	-	\$22.00	—
210K Wave Spring Washer Pkg/10	090103	-	\$13.00	—
210/230 Cylinder Retaining Cup	968201	-	\$22.00	—
210/230 Cylinder Cup & Tailpiece Lead Pkg	900581	-	\$14.00	—
210/230 Tailpiece Guide Lead Pkg/10	050156	-	\$22.00	—
210K Knob Spacer	969140	-	\$17.00	—
210K Knob	969157	.[Finish]	—	\$34.00
210K-BE Knob	969352	.[Finish]	—	\$23.00
230TP Cam	969903	-	\$14.00	—
230TP Slider	969904	-	\$14.00	—
230TP Locking Cam	969906	-	\$14.00	—
230TP Locking Cam Latch	969908	-	\$22.00	—
230TP Compression Spring	969909	-	\$14.00	—
230TP Thumbpiece	969910	.[Finish]	—	\$77.00
210K/L Spindle Shaft	970979	-	\$14.00	—
230L Stud	971245	-	\$15.00	—
230L Cylinder Collar	971249	.[Finish]	—	\$27.00
230L Locking Plunger	971497	-	\$14.00	—
230L Locking Slider	971259	-	\$11.00	—
230L Lever Cam*	050813	-	\$14.00	—
230L Shear Pin Kit w/ Retaining Pin*	050611	-	\$14.00	—

* For 230L trim shipped after 3/3/14.

386/388 SERIES TRIMS

Description	Specify		Non-finished
	Part number	Finish	
386 Housing Retainer Pkg/2	090104	-	\$13.00
386/388 Cylinder Retainer Pkg	900624	-	\$22.00
386 Mounting Stud Kit	050584	-	\$15.00
386 Mounting Stud Set Screw Pkg/2	090105	-	\$11.00
388 Mounting Stud Pkg/2	090106	-	\$15.00
392-6 Mounting Package	900955	-	\$15.00

PARTS AND ACCESSORIES

605	606	611	612	613	619	622	625	626	626AM	628	629
US3	US4	US9	US10	US10B	US15	US19	US26	US26D	US26DAM	US28	US32
630	630AM	643e	689	691	693	695	706	710	711	721	728
US32D	US32DAM	-	SP28	SP10	SPBLK	SP313	SP4	313	315	US3A	US4A

550/110 SERIES TRIMS

Description	Specify		Non-finished	626	613	612	606	605 625 693
	Part number	Finish						
555/556 Cylinder Disc & Cam Assembly	101212	-	\$202.00	-	-	-	-	-
550/555/556 Pull Bar Assembly	108705	.[Finish]	-	-	\$254.00	\$324.00	\$245.00	\$324.00
550DT Screw Package	900760	.[Finish]	-	\$58.00	\$58.00	\$58.00	\$58.00	\$58.00
555NL Screw Package	900761	-	\$58.00	-	-	-	-	-
556NL Screw Package	900784	.[Finish]	-	\$15.00	\$15.00	\$15.00	\$15.00	\$15.00
556 Rod Member	952820	-	\$134.00	-	-	-	-	-
550/555/556 Special Cylinder Screw - 1 3/4" Door	959055	-	\$14.00	-	-	-	-	-
550/555/556 Special Cylinder Screw - 2 1/4" Door	959056	-	\$14.00	-	-	-	-	-
550/555/556 Hex Stud	959560	-	\$14.00	-	-	-	-	-
555 Cylinder Latch Release RH	959563	-	\$51.00	-	-	-	-	-
555NL-MD Cylinder Spacer Collar - 1 3/4" Door	960003	-	\$31.00	-	-	-	-	-
110NL Cylinder Spacer Collar	960060	-	\$51.00	-	-	-	-	-
555 Cylinder Latch Release LH	960109	-	\$51.00	-	-	-	-	-
110NL-WD Cylinder Spacer Collar	960316	-	\$51.00	-	-	-	-	-
555NL Cylinder Spacer Collar - 2 1/4" Door	960317	-	\$31.00	-	-	-	-	-
556NL Cylinder Spacer Collar - 1 3/4" Door	960676	-	\$31.00	-	-	-	-	-
556NL Cylinder Spacer Collar - 2 1/4" Door	960689	-	\$31.00	-	-	-	-	-
550/555/556 Sex Bolt Extension	960902	-	\$15.00	-	-	-	-	-
110NL Cylinder Assembly Countersink Washer	961180	-	\$15.00	-	-	-	-	-
555NL Cylinder Assembly Cylinder Base	961280	.[Finish]	-	\$60.00	\$59.00	\$59.00	\$54.00	\$59.00
1/8" Short Arm Hex Wrench	050613	-	\$15.00	-	-	-	-	-
556 3/32 Short Hex Key	050614	-	\$14.00	-	-	-	-	-
550/555/556 Socket Set Screw	963581	-	\$14.00	-	-	-	-	-
550/555/556 Pull Base	965310	.[Finish]	-	\$82.00	\$82.00	\$90.00	\$82.00	\$90.00
555/556 Cylinder Pull Base	965312	.[Finish]	-	\$64.00	\$64.00	\$76.00	\$59.00	\$76.00
550/555/556 Cylinder Hole Cover	965317	.[Finish]	-	\$60.00	\$60.00	\$94.00	\$60.00	\$94.00
556NL Cylinder Assembly Cylinder Base	966985	.[Finish]	-	\$134.00	\$134.00	\$155.00	\$134.00	\$155.00
110NL-MD Cylinder Collar	967291	.[Finish]	-	\$57.00	\$57.00	\$64.00	\$57.00	\$64.00
110NL Cylinder Assembly Cylinder Disc	971593	-	\$76.00	-	-	-	-	-

880/606/608 SERIES TRIMS¹

Description	Specify		Non-finished	626	613	612	606	605 625 693
	Part number	Finish						
216D Cylinder Anchor Plate 880 Trim	032114	-	\$20.00	-	-	-	-	-
606K/880K Orbit Knob Assembly	110544	.[Finish]	-	\$194.00	\$194.00	\$194.00	\$194.00	\$293.00
606K/880K Orbit Knob Assembly (DT)	110547	.[Finish]	-	\$194.00	\$194.00	\$194.00	\$194.00	\$293.00
880 Screw Package 2 1/4" Dr	900531	.[Finish]	-	\$23.00	\$32.00	\$23.00	\$23.00	\$23.00
880 Screw Package 1 3/4" Dr	900533	.[Finish]	-	\$14.00	\$31.00	\$15.00	\$15.00	\$15.00

¹ For Trims shipped after October 1989. Otherwise, see service replacement page 172.

Z2 SERIES
33A/35A SERIES
55 SERIES
88 SERIES
98/99 SERIES
XP98/XP99 SERIES
94/95 SERIES
GUARD-X SERIES
ACCESSORIES / PARTS
ELECTRICAL / PARTS

PARTS AND ACCESSORIES

605	606	611	612	613	619	622	625	626	626AM	628	629
US3	US4	US9	US10	US10B	US15	US19	US26	US26D	US26DAM	US28	US32
630	630AM	643e	689	691	693	695	706	710	711	721	728
US32D	US32DAM	-	SP28	SP10	SPBLK	SP313	SP4	313	315	US3A	US4A

880/606/608 SERIES TRIMS¹

Description	Specify		Non-finished	626	613	612	606	605 625 693
	Part number	Finish						
880-V Screw Package Trim	900542	-	\$14.00	-	-	-	-	-
880 Screw Package (Bottom Stud)	900771	.[Finish]	-	\$14.00	\$14.00	\$14.00	\$14.00	\$14.00
880DT-V SA Screw Package	900783	.[Finish]	-	\$17.00	\$17.00	\$17.00	\$17.00	\$17.00
606DT/NL/TP Screw Package	900772	.[Finish]	-	\$14.00	\$14.00	\$14.00	\$14.00	\$14.00
606K/606K-DT Screw Package	900782	.[Finish]	-	\$17.00	\$17.00	\$17.00	\$17.00	\$17.00
608 Screw Package	900776	.[Finish]	-	\$15.00	\$15.00	\$15.00	\$15.00	\$15.00
880 Series Hex Stud	956760	-	\$14.00	-	-	-	-	-
880 Pull Grip	972467	.[Finish]	-	-	\$140.00	-	\$115.00	\$186.00
880 Pull Grip	972466	.[Finish]	-	\$140.00	-	-	-	-
880-M/V Thumbpiece	959575	.[Finish]	-	\$74.00	\$74.00	\$68.00	\$68.00	\$104.00
880 Thumbpiece Axle	959603	-	\$14.00	-	-	-	-	-

¹ For Trims shipped after October 1989. Otherwise, see service replacement page 172.

880/606/608 SERIES TRIMS¹

Description	Specify		Non-finished	626 630 ¹	613	612	606	605, 619, ² 625, 629, ¹ 693
	Part number	Finish						
880-M Cylinder Collar	961267	.[Finish]	-	\$48.00	-	\$58.00	\$48.00	\$58.00
880DT-V-SA 12-24 x 1/2" UFPHMS	963011	-	\$13.00	-	-	-	-	-
606K/880K Roll Pin (3-32 x 7/8)	963196	-	\$13.00	-	-	-	-	-
880NL/DT 12-24 x 3/8" UFPHMS	963579	-	\$14.00	-	-	-	-	-
606K/880K 3/8" Lockwasher	963703	-	\$13.00	-	-	-	-	-
606K/880K-DT/K-NL Hex Nut	963704	-	\$13.00	-	-	-	-	-
880-R Cylinder Collar	965226	.[Finish]	-	\$48.00	\$48.00	\$58.00	\$48.00	\$58.00
880 TP Bracket Screw	965237	-	\$13.00	-	-	-	-	-
606/880 DT Spindle Lock	965568	-	\$13.00	-	-	-	-	-
Extended Spindle - 880K	968883	-	\$213.00	-	-	-	-	-
880TP Thumbpiece Bracket	969353	-	\$14.00	-	-	-	-	-
880K Booster Body	970137	-	\$34.00	-	-	-	-	-
880K Booster Torsion Spring	970138	-	\$13.00	-	-	-	-	-
880K Booster Spacer	970139	-	\$13.00	-	-	-	-	-
880K Flange Bearing - 880K	970159	-	\$15.00	-	-	-	-	-
608/880TP-R Thumbpiece	970488	.[Finish]	-	\$74.00	\$74.00	\$104.00	\$68.00	\$104.00

¹ For Trims shipped after October 1989. Otherwise, see service replacement page 172.

² 619 finish available with device series 98 trims.

PARTS AND ACCESSORIES

605	606	611	612	613	619	622	625	626	626AM	628	629
US3	US4	US9	US10	US10B	US15	US19	US26	US26D	US26DAM	US28	US32
630	630AM	643e	689	691	693	695	706	710	711	721	728
US32D	US32DAM	-	SP28	SPI0	SPBLK	SP313	SP4	313	315	US3A	US4A

990/996 SERIES TRIM

Description	Specify		Non-finished	626, 630	613	612	606	605, 619, ¹ 625, 629, 693
	Part number	Finish						
#01 Lever - 992 RMV/994/996 L-DT/L-NL	050001	.[Finish]	-	\$230.00	\$230.00	\$259.00	\$230.00	\$314.00
#02 Lever - 992 RMV/994/996 L-DT/L-NL	050002	.[Finish]	-	\$230.00	\$230.00	\$259.00	\$230.00	\$314.00
#03 Lever - 992 RMV/994/996 L-DT/L-NL	050003	.[Finish]	-	\$230.00	\$230.00	\$259.00	\$230.00	\$314.00
#05 Lever - 992 RMV/994/996 L-DT/L-NL	050008	.[Finish]	-	\$230.00	\$230.00	\$259.00	\$230.00	\$314.00
#06 Lever - 992 RMV/994/996 L-DT/L-NL	050006	.[Finish]	-	\$230.00	\$230.00	\$259.00	\$230.00	\$314.00
#07 Lever - 992 RMV/994/996 L-DT/L-NL	050007	.[Finish]	-	\$230.00	\$230.00	\$259.00	\$230.00	\$314.00
#12 Lever - 992 RMV/994/996 L-DT/L-NL (RHR)	050012	.[Finish]	-	\$230.00	\$230.00	\$259.00	\$230.00	\$314.00
#12 Lever - 992 RMV/994/996 L-DT/L-NL (LHR)	050013	.[Finish]	-	\$230.00	\$230.00	\$259.00	\$230.00	\$314.00
#16 Lever - 992 RMV/994/996 L-DT/L-NL	050009	.[Finish]	-	\$230.00	\$230.00	\$259.00	\$230.00	\$314.00
#17 Lever - 992 RMV/994/996 L-DT/L-NL	050017	.[Finish]	-	\$230.00	\$230.00	\$259.00	\$230.00	\$314.00
#18 Lever - 992 RMV/994/996 L-DT/L-NL	050010	.[Finish]	-	\$230.00	\$230.00	\$259.00	\$230.00	\$314.00
#01 Lever - 994/996 RMV L/L-BE	050732	.[Finish]	-	\$230.00	\$230.00	\$259.00	\$230.00	\$314.00
#02 Lever - 994/996 RMV L/L-BE	050733	.[Finish]	-	\$230.00	\$230.00	\$259.00	\$230.00	\$314.00
#03 Lever - 994/996 RMV L/L-BE	050734	.[Finish]	-	\$230.00	\$230.00	\$259.00	\$230.00	\$314.00
#05 Lever - 994/996 RMV L/L-BE	050735	.[Finish]	-	\$230.00	\$230.00	\$259.00	\$230.00	\$314.00
#06 Lever - 994/996 RMV L/L-BE	050736	.[Finish]	-	\$230.00	\$230.00	\$259.00	\$230.00	\$314.00
#07 Lever - 994/996 RMV L/L-BE	050737	.[Finish]	-	\$230.00	\$230.00	\$259.00	\$230.00	\$314.00
#12 Lever - 994/996 RMV L/L-BE RHR	050738	.[Finish]	-	\$230.00	\$230.00	\$259.00	\$230.00	\$314.00
#12 Lever - 994/996 RMV L/L-BE LHR	050739	.[Finish]	-	\$230.00	\$230.00	\$259.00	\$230.00	\$314.00
#16 Lever - 994/996 RMV L/L-BE	050740	.[Finish]	-	\$230.00	\$230.00	\$259.00	\$230.00	\$314.00
#17 Lever - 994/996 RMV L/L-BE	050741	.[Finish]	-	\$230.00	\$230.00	\$259.00	\$230.00	\$314.00
#18 Lever - 994/996 RMV L/L-BE	050742	.[Finish]	-	\$230.00	\$230.00	\$259.00	\$230.00	\$314.00
LON Lever - 996 RMV L/L-BE	051874	.[Finish]	-	\$230.00	\$230.00	\$259.00	\$230.00	\$314.00
LAT Lever - 996 RMV L/L-BE	051872	.[Finish]	-	\$230.00	\$230.00	\$259.00	\$230.00	\$314.00

¹ 619 finish available with device series 98 trims.

990/996 SERIES TRIM (CONTINUED)

Description	Specify		Non-finished	626	613	612	606	605 619 ¹ 625 693	629 630	643e	622	695
	Part number	Finish										
ME1LH Lever Kit - 996 RMV L/L-BE	044000	.[Finish]	-	\$336.00	\$336.00	\$336.00	\$336.00	\$336.00	-	\$336.00	\$336.00	\$336.00
ME1RH Lever Kit - 996 RMV L/L-BE	044001	.[Finish]	-	\$336.00	\$336.00	\$336.00	\$336.00	\$336.00	-	\$336.00	\$336.00	\$336.00
ME2LH Lever Kit - 996 RMV L/L-BE	044002	.[Finish]	-	\$336.00	\$336.00	\$336.00	\$336.00	\$336.00	-	\$336.00	\$336.00	\$336.00
ME2RH Lever Kit - 996 RMV L/L-BE	044003	.[Finish]	-	\$336.00	\$336.00	\$336.00	\$336.00	\$336.00	-	\$336.00	\$336.00	\$336.00
ME3LH Lever Kit - 996 RMV L/L-BE	044004	.[Finish]	-	\$336.00	\$336.00	\$336.00	\$336.00	\$336.00	-	\$336.00	\$336.00	\$336.00
ME1LH Lever Kit - 996 RMV L/L-BE	044005	.[Finish]	-	-	-	-	-	-	\$336.00	-	-	-
ME1RH Lever Kit - 996 RMV L/L-BE	044006	.[Finish]	-	-	-	-	-	-	\$336.00	-	-	-
ME2LH Lever Kit - 996 RMV L/L-BE	044007	.[Finish]	-	-	-	-	-	-	\$336.00	-	-	-

¹ 619 finish available with device series 98 trims.

PARTS AND ACCESSORIES

605	606	611	612	613	619	622	625	626	626AM	628	629
US3	US4	US9	US10	US10B	US15	US19	US26	US26D	US26DAM	US28	US32
630	630AM	643e	689	691	693	695	706	710	711	721	728
US32D	US32DAM	-	SP28	SP10	SPBLK	SP313	SP4	313	315	US3A	US4A

990/996 SERIES TRIM (CONTINUED)

Description	Specify		Non-finished	626	613	612	606	605 619 ¹ 625 693	629 630	643e	622	695
	Part number	Finish										
ME2RH Lever Kit - 996 RMV L/L-BE	044008	.[Finish]	-	-	-	-	-	-	\$336.00	-	-	-
ME3 Lever Kit - 996 RMV L/L-BE	044009	.[Finish]	-	-	-	-	-	-	\$336.00	-	-	-
M51 Lever Kit - 996 RMV L/L-BE	114811	.[Finish]	-	\$336.00	\$336.00	\$336.00	\$336.00	\$336.00	-	-	-	\$336.00
M51 Lever Kit - 996 RMV L/L-BE	114813	.[Finish]	-	-	-	-	-	-	\$336.00	-	-	-
M52 Lever Kit - 996 RMV L/L-BE	051921	.[Finish]	-	\$336.00	\$336.00	\$336.00	\$336.00	\$336.00	-	-	-	\$336.00
M52 Lever Kit - 996 RMV L/L-BE	051923	.[Finish]	-	-	-	-	-	-	\$336.00	-	-	-
M53 Lever Kit - 996 RMV L/L-BE	051929	.[Finish]	-	\$336.00	\$336.00	\$336.00	\$336.00	\$336.00	-	-	-	\$336.00
M53 Lever Kit - 996 RMV L/L-BE	051931	.[Finish]	-	-	-	-	-	-	\$336.00	-	-	-
M54 Lever Kit - 996 RMV L/L-BE	114827	.[Finish]	-	\$336.00	\$336.00	\$336.00	\$336.00	\$336.00	-	-	-	\$336.00
M54 Lever Kit - 996 RMV L/L-BE	114829	.[Finish]	-	-	-	-	-	-	\$336.00	-	-	-
M55 Lever Kit - 996 RMV L/L-BE	051937	.[Finish]	-	\$336.00	\$336.00	\$336.00	\$336.00	\$336.00	-	-	-	\$336.00
M55 Lever Kit - 996 RMV L/L-BE	051939	.[Finish]	-	-	-	-	-	-	\$336.00	-	-	-
M56 Lever Kit - 996 RMV L/L-BE	114823	.[Finish]	-	\$336.00	\$336.00	\$336.00	\$336.00	\$336.00	-	-	-	\$336.00
M56 Lever Kit - 996 RMV L/L-BE	114825	.[Finish]	-	-	-	-	-	-	\$336.00	-	-	-
M57 Lever Kit - 996 RMV L/L-BE	051915	.[Finish]	-	-	-	-	-	-	\$336.00	-	-	-
M61LH Lever Kit- 996 RMV L/L-BE	114815	.[Finish]	-	\$336.00	\$336.00	\$336.00	\$336.00	\$336.00	-	-	-	\$336.00
M61LH Lever Kit- 996 RMV L/L-BE	114817	.[Finish]	-	-	-	-	-	-	\$336.00	-	-	-
M61RH Lever Kit- 996 RMV L/L-BE	114819	.[Finish]	-	\$336.00	\$336.00	\$336.00	\$336.00	\$336.00	-	-	-	\$336.00
M61RH Lever Kit- 996 RMV L/L-BE	114821	.[Finish]	-	-	-	-	-	-	\$336.00	-	-	-
M62LH Lever Kit- 996 RMV L/L-BE	051917	.[Finish]	-	-	-	-	-	-	\$336.00	-	-	-
M62RH Lever Kit- 996 RMV L/L-BE	051919	.[Finish]	-	-	-	-	-	-	\$336.00	-	-	-
M63LH Lever Kit- 996 RMV L/L-BE	114843	.[Finish]	-	\$336.00	\$336.00	\$336.00	\$336.00	\$336.00	-	-	-	\$336.00
M63LH Lever Kit- 996 RMV L/L-BE	114845	.[Finish]	-	-	-	-	-	-	\$336.00	-	-	-
M63RH Lever Kit- 996 RMV L/L-BE	114847	.[Finish]	-	\$336.00	\$336.00	\$336.00	\$336.00	\$336.00	-	-	-	\$336.00
M63RH Lever Kit- 996 RMV L/L-BE	114849	.[Finish]	-	-	-	-	-	-	\$336.00	-	-	-
M81 Lever Kit - 996 RMV L/L-BE	051925	.[Finish]	-	\$336.00	\$336.00	\$336.00	\$336.00	\$336.00	-	-	-	\$336.00
M81 Lever Kit - 996 RMV L/L-BE	051927	.[Finish]	-	-	-	-	-	-	\$336.00	-	-	-
M82 Lever Kit - 996 RMV L/L-BE	051933	.[Finish]	-	\$336.00	\$336.00	\$336.00	\$336.00	\$336.00	-	-	-	\$336.00
M82 Lever Kit - 996 RMV L/L-BE	051935	.[Finish]	-	-	-	-	-	-	\$336.00	-	-	-
M83 Lever Kit - 996 RMV L/L-BE	114831	.[Finish]	-	\$336.00	\$336.00	\$336.00	\$336.00	\$336.00	-	-	-	\$336.00
M83 Lever Kit - 996 RMV L/L-BE	114833	.[Finish]	-	-	-	-	-	-	\$336.00	-	-	-
M84 Lever Kit - 996 RMV L/L-BE	114851	.[Finish]	-	\$336.00	\$336.00	\$336.00	\$336.00	\$336.00	-	-	-	\$336.00
M84 Lever Kit - 996 RMV L/L-BE	114853	.[Finish]	-	-	-	-	-	-	\$336.00	-	-	-
M85LH Lever Kit- 996 RMV L/L-BE	114835	.[Finish]	-	\$336.00	\$336.00	\$336.00	\$336.00	\$336.00	-	-	-	\$336.00
M85LH Lever Kit- 996 RMV L/L-BE	114837	.[Finish]	-	-	-	-	-	-	\$336.00	-	-	-
M85RH Lever Kit- 996 RMV L/L-BE	114839	.[Finish]	-	\$336.00	\$336.00	\$336.00	\$336.00	\$336.00	-	-	-	\$336.00
M85RH Lever Kit- 996 RMV L/L-BE	114841	.[Finish]	-	-	-	-	-	-	\$336.00	-	-	-

¹ 619 finish available with device series 98 trims.

PARTS AND ACCESSORIES

605	606	611	612	613	619	622	625	626	626AM	628	629
US3	US4	US9	US10	US10B	US15	US19	US26	US26D	US26DAM	US28	US32
630	630AM	643e	689	691	693	695	706	710	711	721	728
US32D	US32DAM	-	SP28	SP10	SPBLK	SP313	SP4	313	315	US3A	US4A

990/996 SERIES TRIM (CONTINUED)

Description	Specify		Non-finished	626	613	612	606	605, 619, 625, 693	629 630
	Part number	Finish							
Orbit Knob Assembly - 991K	110537	.[Finish]	-	\$132.00	\$155.00	\$212.00	\$176.00	\$224.00	-
Slider Sub-Assembly - 991K-R/V	110768	-	\$138.00	-	-	-	-	-	-
Slider Sub-Assembly - 992L-R/V	110769	-	\$152.00	-	-	-	-	-	-
Slider Sub-Assembly - 994/996L-R/V	111869	-	\$176.00	-	-	-	-	-	-
Slider Sub-Assembly - 994/996L-M	112462	-	\$176.00	-	-	-	-	-	-
990 Screw Package 1 3/4" - 2 1/4" Door	900853	.[Finish]	-	\$31.00	\$31.00	\$31.00	\$31.00	\$31.00	-
991/992/994/996 Screw Package	900920	-	\$14.00	-	-	-	-	-	-
Cam-996	971132	-	\$38.00	-	-	-	-	-	-
392-7 Mounting Pack	900954	.[Finish]	-	\$15.00	-	-	-	-	-
Hex Stud - 990 Trim	956760	-	\$14.00	-	-	-	-	-	-
Pull Grip - 990	972467	.[Finish]	-	-	\$140.00	-	\$115.00	\$186.00	-
Pull Grip - 990	972466	.[Finish]	-	\$140.00	-	-	-	-	-
Thumbpiece - 696/990-M	959575	.[Finish]	-	\$74.00	\$74.00	\$68.00	\$68.00	\$104.00	-
Thumbpiece Axle - 696/990	959603	-	\$14.00	-	-	-	-	-	-
Cylinder Collar - 696/990-M	961267	.[Finish]	-	\$48.00	\$48.00	\$58.00	\$48.00	\$58.00	-
Flat Washer - 992K-DT/NL/BE/992L	963105	-	\$15.00	-	-	-	-	-	-
12-24 x 3/8" UFPHMS - 990NL/DT	963579	-	\$14.00	-	-	-	-	-	-
Retaining Ring - 991K	963767	-	\$14.00	-	-	-	-	-	-
Retaining Ring - 992L	964097	-	\$14.00	-	-	-	-	-	-
10-24 x 1/2" Socket Set Cap Screw	964183	-	\$14.00	-	-	-	-	-	-
Retaining Ring - 991K-DT/NL/BE/992L	964285	-	\$14.00	-	-	-	-	-	-
1/4-20 x 5/8" Socket Set Screw	964353	-	\$14.00	-	-	-	-	-	-
Cylinder Collar - 990-R	965226	.[Finish]	-	\$48.00	\$48.00	\$58.00	\$48.00	\$58.00	-
TP Bracket Screw - 990TP	965237	-	\$13.00	-	-	-	-	-	-
Cylinder Retaining Cup - 990/996 Trim	968201	-	\$22.00	-	-	-	-	-	-
Spring - 991K	969012	-	\$14.00	-	-	-	-	-	-
Thumbpiece Bracket - 990TP	969353	-	\$14.00	-	-	-	-	-	-
R&V Finger - 991K/992L	969545	-	\$17.00	-	-	-	-	-	-
Flange Bearing - 991K	970159	-	\$15.00	-	-	-	-	-	-
Thumbpiece - 990TP-R	970488	.[Finish]	-	\$74.00	\$74.00	\$104.00	\$68.00	\$104.00	-
Slider Sub-Assembly - 992L-M	971012	-	\$152.00	-	-	-	-	-	-
996L-DT/NL Retaining Plate Kit	044020	-	\$132.00	-	-	-	-	-	-
DT Cam Pin - 992/994/996	971015	-	\$15.00	-	-	-	-	-	-
Hex Stud - 991K/992L	971440	-	\$14.00	-	-	-	-	-	-
Lift Spring - 992/994	971573	-	\$11.00	-	-	-	-	-	-
Shear Pin Kit - 992/994/996 w/retaining ring	050611	-	\$14.00	-	-	-	-	-	-
Mounting Stud - 994/996	971585	-	\$14.00	-	-	-	-	-	-
M996 Mort Conv to Motorized Kit	47273112	-	\$770.00	-	-	-	-	-	-
M996 R/V/C Conv to Motorized Kit	47273111	-	\$740.00	-	-	-	-	-	-
M996 Wire Harness	CABLE.10038	-	\$50.00	-	-	-	-	-	-
Lever Bushing	050579	-	\$14.00	-	-	-	-	-	-

¹ 619 finish available with device series 98 trims

ELECTRICAL / PARTS ACCESSORIES / PARTS GUARD-X SERIES 94/95 SERIES XP98/XP99 SERIES 98/99 SERIES 88 SERIES 55 SERIES 33A/35A SERIES 22 SERIES

PARTS AND ACCESSORIES

605	606	611	612	613	619	622	625	626	626AM	628	629
US3	US4	US9	US10	US10B	US15	US19	US26	US26D	US26DAM	US28	US32
630	630AM	643e	689	691	693	695	706	710	711	721	728
US32D	US32DAM	-	SP28	SP10	SPBLK	SP313	SP4	313	315	US3A	US4A

OPTIONAL TRIM

Description	Specify		Non-finished	626	695 613	612	606	605 625 693
	Part number	Finish						
696/697DT x 330/350 Screw Package 1 3/4" Dr	050142	.[Finish]	-	\$17.00	\$17.00	\$17.00	\$17.00	\$17.00
696/697DT x 330/350 Screw Package 2 1/4" Dr	050143	.[Finish]	-	-	\$17.00	\$17.00	\$17.00	\$17.00
696/697 Cylinder Hardware Assembly 1 3/4" Dr	109369	.[Finish]	-	\$104.00	\$104.00	\$155.00	\$134.00	\$177.00
696/697 Cylinder Hardware Assembly 2 1/4" Dr	109130	.[Finish]	-	\$104.00	\$104.00	\$155.00	\$134.00	\$177.00
696/697 Screw Package 1 3/4" Door	900839	.[Finish]	-	\$14.00	\$14.00	\$14.00	\$14.00	\$14.00
696/697 Screw Package 2 1/4" Door	900840	.[Finish]	-	\$14.00	\$14.00	\$14.00	\$14.00	\$14.00
Pull Grip - 608/696 Trim	972467	.[Finish]	-	-	\$140.00	-	\$115.00	\$186.00
Pull Grip - 608/696 Trim	972466	.[Finish]	-	\$140.00	-	-	-	-
Thumbpiece - 608 Trim	959575	.[Finish]	-	\$74.00	\$74.00	\$68.00	\$68.00	\$104.00
Thumbpiece Axle - 608 Trim	959603	-	\$14.00	-	-	-	-	-
Sex Bolt Extension - 606/608 Trim	960902	-	\$15.00	-	-	-	-	-
Thumbpiece Bracket - 608TP-R/V	960921	-	\$25.00	-	-	-	-	-
3/8" Lockwasher - 606K	963703	-	\$13.00	-	-	-	-	-
Hex Nut - 606K-DT/K-NL	963704	-	\$13.00	-	-	-	-	-
1/4-20 3/4" Socket Set Screw	964355	-	\$14.00	-	-	-	-	-
Thumbpiece Bracket - 608TP-M	965130	-	\$54.00	-	-	-	-	-
Sex Bolt Head - 606/608 Trim	967329	.[Finish]	-	\$17.00	\$17.00	\$17.00	\$17.00	\$17.00
Pull Grip - 697 Trim	968694	.[Finish]	-	\$237.00	\$237.00	\$237.00	\$237.00	\$277.00
Sex Bolt Head - 696/697 Trim	968918	.[Finish]	-	\$17.00	\$17.00	\$17.00	\$17.00	\$17.00
Hex Stud - 696/697 Trim	969091	-	\$14.00	-	-	-	-	-
Sex Bolt Extension - 696/697 Trim	969092	-	\$17.00	-	-	-	-	-
Thumbpiece - 608TP-R	970488	.[Finish]	-	\$74.00	\$74.00	\$104.00	\$68.00	\$104.00
Thumbpiece - 696/697-R/V	970491	.[Finish]	-	\$74.00	\$74.00	\$104.00	\$68.00	\$104.00
334 Cylinder Collar	961267	.[Finish]	-	\$48.00	\$48.00	\$58.00	\$48.00	\$58.00
940 Trim Cam Service Kit	040171	-	\$139.00	-	-	-	-	-
940 Tail Piece Mounting Pkg	900390	-	\$24.00	-	-	-	-	-

CONTROL TRIMS

605	606	611	612	613	619	622	625	626	626AM	628	629
US3	US4	US9	US10	US10B	US15	US19	US26	US26D	US26DAM	US28	US32
630	630AM	643e	689	691	693	695	706	710	711	721	728
US32D	US32DAM	-	SP28	SP10	SPBLK	SP313	SP4	313	315	US3A	US4A

360 SERIES

360 SERIES									
Description	Specify		626	613, 693	629 ¹ 630 ¹	612	606	605 625 643e	619
	Model number	Finish							
STANDARD LEVER DESIGNS									
Lever, Key unlocks - 33/35A Rim, 33/3527A, 33/3547A	360L ²	[Finish]	\$721.00	\$743.00	\$827.00	\$776.00	\$690.00	\$803.00	\$827.00
Lever, Blank Escutcheon - 33/35A Rim, 33/3527A, 33/3547A	360L-BE	[Finish]	\$675.00	\$697.00	\$781.00	\$730.00	\$644.00	\$757.00	\$781.00
Lever, Dummy - 33/35A Rim, 33/3527A, 33/3547A	360L-DT	[Finish]	\$666.00	\$688.00	\$772.00	\$721.00	\$635.00	\$748.00	\$772.00
M COLLECTION LEVER DESIGNS									
Lever, Key unlocks - 33/35A Rim, 33/3527A, 33/3547A	360L ²	[Finish]	\$847.00	\$847.00	\$847.00	\$847.00	\$827.00	\$847.00	\$847.00
Lever, Blank Escutcheon - 33/35A Rim, 33/3527A, 33/3547A	360L-BE	[Finish]	\$801.00	\$801.00	\$801.00	\$801.00	\$781.00	\$801.00	\$801.00
Lever, Dummy - 33/35A Rim, 33/3527A, 33/3547A	360L-DT	[Finish]	\$792.00	\$792.00	\$792.00	\$792.00	\$772.00	\$792.00	\$792.00

¹ 630 lever furnished with 619 trim plate. 629 lever furnished with 625 trim plate. 619 control trim for use on 35A Series device only.

² L function is field-convertible to L-NL.

OPTIONS

STANDARD LEVER DESIGNS	
Standard	06 (furnished standard when lever design is not specified)
Optional - 360	01, 02, 03, 03-SS ¹ , 05, 06-SS ¹ , 07, 12, 16, 17, 17-SS ¹ , 18, Accent (ACC), Asti (AST), Merano (MER), Latitude (LAT), LAT-SS ¹ , Longitude (LON), LON-SS ¹
Special order - E360	01, 02, 03, 05, 07, 12, 16, 17, Latitude (LAT) Special order ☒: 03-SS ¹ , 06-SS ¹ , 17-SS ¹ , 18, Accent (ACC), Asti (AST), LAT-SS ¹ , Longitude (LON), LON-SS ¹ , Merano (MER)
Special order - 643e finish	Special order ☒: 18, Accent (ACC), Asti (AST), Merano (MER).
M COLLECTION LEVER DESIGNS	
Optional - 360	M51, M52, M53, M54, M55, M56, M57 ¹ , M61, M62 ¹ , M63, M81, M82, M83, M84, M85, ME1, ME2, ME3
Optional - E360	M51, M52, M53, M54, M55, M56, M57 ¹ , M61, M62 ¹ , M63, M81, M82, M83, M84, M85, ME1, ME2, ME3
Special order - 643e finish	Special order ☒: M51, M52, M53, M54, M55, M56, M57 ¹ , M61, M62 ¹ , M63, M81, M82, M83, M84, M85.
HANDING	
<ul style="list-style-type: none"> Handing is field reversible and furnished RHR if not specified on all lever designs except 12, AST, MER, ACC, M61, M62, M63, M85 Specify handing RHR or LHR for lever designs 12, AST, MER, ACC, M61, M62, M63, M85, ME1, ME2 	

KNURLED LEVER	Specify (Suffix)	Price adjustment
Available standard on 03, 06, ME1, ME2, and ME3 lever designs. Specify suffix KN (06-KN).	KN	\$112.00
Available for special order on 02, 17, M51, M52, and M81 lever designs. Specify suffix KN (02-KN). ☒		\$171.00

ANTI-MICROBIAL FINISH	Specify (Suffix)	Price adjustment
626-AM - Antimicrobial Coating on 626 finish available standard.	AM	\$34.00
630-AM - Antimicrobial Coating on 630 finish available for special order on lever designs 03-SS, 06-SS, 17-SS, LAT-SS, LON-SS, M57, M62.		\$34.00

¹ Stainless Steel Levers (SS) - are available in 630 or 629. 619 control trim for use on 35A Series device only.

☒ Consult factory for lead time.

For other possible trim applications not shown, consult Von Duprin.

CONTROL TRIMS

605	606	611	612	613	619	622	625	626	626AM	628	629
US3	US4	US9	US10	US10B	US15	US19	US26	US26D	US26DAM	US28	US32
630	630AM	643e	689	691	693	695	706	710	711	721	728
US32D	US32DAM	-	SP28	SP10	SPBLK	SP313	SP4	313	315	US3A	US4A

360 SERIES

OPTIONS

SOLID WOOD OR COMPOSITE DOORS	Specify (Suffix)	Price adjustment
Required when used on solid wood or composite doors	33-WDA	\$56.00
DOOR THICKNESS >2-1/4" - 4 1/4"	Specify (Suffix)	Price adjustment
360L, LBE	Door Thickness > 2-1/4" - <= 4 1/4"	\$139.00
360L-DT		\$94.00
ELECTRIC UNLOCKING	Specify (Suffix)	Price adjustment
<ul style="list-style-type: none"> Electric Unlocking of outside trim for use on all device types except mortise lock devices Must be furnished LBE functions only, specify handing. Prefix trim "E" (example E360) Specify Fail Safe (FS) or Fail Secure (FSE). 24VDC furnished standard, 12VDC available through special order. ☞ 	E	\$661.00

¹ Stainless Steel Levers (SS) - are available in 630 or 629 . 619 control trim for use on 35A series device only.

☞ Consult factory for lead time.

370 SERIES

Description	Specify		626	613 693	612	606	605 625 643e
	Model number	Finish					
Lever, Key unlocks - 5547/8847-F	371L	.[Finish]	\$782.00	\$772.00	\$782.00	\$669.00	\$861.00
Lever, Blank Escutcheon - 5547/8847-F	371L-BE	.[Finish]	\$746.00	\$736.00	\$746.00	\$633.00	\$825.00
Lever, Key unlocks - 88 Rim, 8827/8875	373L	.[Finish]	\$728.00	\$718.00	\$728.00	\$615.00	\$807.00
Lever, Blank Escutcheon - 88 Rim, 8827/8875	373L-BE	.[Finish]	\$689.00	\$679.00	\$689.00	\$576.00	\$768.00
Lever, Dummy - 88 Rim, 8827/8875	373L-DT	.[Finish]	\$669.00	\$659.00	\$669.00	\$556.00	\$748.00
Lever, Key unlocks - 5575	375L	.[Finish]	\$929.00	\$919.00	\$929.00	\$816.00	\$1,008.00
Lever, Blank Escutcheon - 5575	375L-BE	.[Finish]	\$886.00	\$876.00	\$886.00	\$773.00	\$965.00
Lever, Dummy - 5575	375L-DT	.[Finish]	\$873.00	\$863.00	\$873.00	\$760.00	\$952.00
Lever, Key unlocks - 5547	376L	.[Finish]	\$923.00	\$913.00	\$923.00	\$810.00	\$1,002.00
Lever, Blank Escutcheon - 5547/8847-F	376L-BE	.[Finish]	\$886.00	\$876.00	\$886.00	\$773.00	\$965.00
Lever, WD - Key unlocks - 5547WDC	376WDC-L	.[Finish]	\$923.00	\$913.00	\$923.00	\$810.00	\$1,002.00
Lever, WD, Blank Escutcheon - 5547WDC	376WDC-L-BE	.[Finish]	\$886.00	\$876.00	\$886.00	\$773.00	\$965.00
Lever, Key Unlocks - 237	378L	.[Finish]	\$777.00	\$767.00	\$777.00	\$664.00	\$856.00
Lever, Blank Escutcheon - 237	378L-BE	.[Finish]	\$726.00	\$716.00	\$726.00	\$613.00	\$805.00
Lever, Key Unlocks - 55 Rim	379L	.[Finish]	\$945.00	\$935.00	\$945.00	\$832.00	\$1,024.00
Lever, Blank Escutcheon - 55 Rim	379L-BE	.[Finish]	\$906.00	\$896.00	\$906.00	\$793.00	\$985.00

CONTROL TRIMS

370 SERIES

605	606	611	612	613	619	622	625	626	626AM	628	629
US3	US4	US9	US10	US10B	US15	US19	US26	US26D	US26DAM	US28	US32
630	630AM	643e	689	691	693	695	706	710	711	721	728
US32D	US32DAM	-	SP28	SP10	SPBLK	SP313	SP4	313	315	US3A	US4A

OPTIONS

LEVER DESIGNS

Standard	06 (furnished standard when lever design is not specified)
Optional	01, 02, 03, 07, 12, 16, 17
Special order [ⓧ]	05, 18, ASTI

HANDING

Requires handing, specify RHR or LHR

KNURLED LEVER

Available standard on 02, 03, 06, 07, and 17 lever designs. Specify suffix KN (06-KN).

Specify (Suffix)

KN

Price adjustment

\$112.00

ANTI-MICROBIAL FINISH

Antimicrobial Coating available in 626, use suffix-AM when ordering. Example 626-AM

Specify (Suffix)

AM

Price adjustment

\$34.00

SOLID WOOD OR COMPOSITE DOORS

Required when used on solid wood or composite doors

Specify (Suffix)

10WDA

Price adjustment

\$56.00

ELECTRIC UNLOCKING

- Electric Unlocking of outside trim for use on all device types except mortise lock devices
- Available for 373. For all other 370 Controls, available through special order.
- Must be furnished LBE functions only, specify handing.
- Prefix trim "E" (example E373)
- Specify Fail Safe (FS) or Fail Secure (FSE). 24VDC furnished standard, 12VDC available through special order. [ⓧ]

Specify (Suffix)

E

Price adjustment

\$661.00

[ⓧ] Consult factory for lead time.

PARTS AND ACCESSORIES

360/370 SERIES CONTROLS

Description	Model	Specify		Non-finished	613 626	606	612	605, 619, ¹ 625, 693	629, 630
		Part number	Finish						
Rod Member Kit 1 3/4" Door	371	109126	-	\$130.00	-	-	-	-	-
Rod Member Kit 2 1/4" Door	371	109127	-	\$130.00	-	-	-	-	-
Rod Member Kit 1 3/4" Door	377	109132	.[Finish]	-	\$155.00	\$155.00	\$181.00	\$207.00	-
Rod Member Kit 2 1/4" Door	377	109133	.[Finish]	-	\$155.00	\$155.00	\$181.00	\$207.00	-
Rod Member Kit 1 3/4" Door	374	109366	.[Finish]	-	\$216.00	\$216.00	\$216.00	\$277.00	-
Rod Member Kit 2 1/4" Door	374	109367	.[Finish]	-	\$216.00	\$216.00	\$216.00	\$277.00	-
Rod Member Kit 1 3/4" Door	376	109112	-	\$82.00	-	-	-	-	-
Rod Member Kit 2" Door	376	900582	.[Finish]	-	\$152.00	\$152.00	\$152.00	\$152.00	-

¹ 619 finish available with Series 35 and 98 controls, only.

PARTS AND ACCESSORIES

605	606	611	612	613	619	622	625	626	626AM	628	629
US3	US4	US9	US10	US10B	US15	US19	US26	US26D	US26DAM	US28	US32
630	630AM	643e	689	691	693	695	706	710	711	721	728
US32D	US32DAM	-	SP28	SPI0	SPBLK	SP313	SP4	313	315	US3A	US4A

360/370 SERIES CONTROLS

Description	Model	Specify		Non-finished	613 626	606	612	605, 619, ¹ 625, 693	629, 630
		Part number	Finish						
Rod Member Kit 2 1/4" Door	376	109115	-	\$152.00	-	-	-	-	-
Rod Member Kit 1 3/4" - 2" Door	376WDC	900558	-	\$142.00	-	-	-	-	-
Rod Member Kit 2 1/4" Door	376WDC	900559	-	\$207.00	-	-	-	-	-
Rod Member Kit 1 3/4" Door	237	112843	-	\$115.00	-	-	-	-	-
#01 Lever Kit	360	050001	.[Finish]	-	\$230.00	\$230.00	\$259.00	\$314.00	-
#02 Lever Kit	360	050002	.[Finish]	-	\$230.00	\$230.00	\$259.00	\$314.00	-
#03 Lever Kit	360	050003	.[Finish]	-	\$230.00	\$230.00	\$259.00	\$314.00	-
#05 Lever Kit	360	050008	.[Finish]	-	\$230.00	\$230.00	\$259.00	\$314.00	-
#06 Lever Kit	360	050006	.[Finish]	-	\$230.00	\$230.00	\$259.00	\$314.00	-
#07 Lever Kit	360	050007	.[Finish]	-	\$230.00	\$230.00	\$259.00	\$314.00	-
#12 Lever RHR Kit	360	050012	.[Finish]	-	\$230.00	\$230.00	\$259.00	\$314.00	-
#12 Lever LHR Kit	360	050013	.[Finish]	-	\$230.00	\$230.00	\$259.00	\$314.00	-
#16 Lever Kit	360	050009	.[Finish]	-	\$230.00	\$230.00	\$259.00	\$314.00	-
#17 Lever Kit	360	050017	.[Finish]	-	\$230.00	\$230.00	\$259.00	\$314.00	-
#18 Lever Kit	360	050010	.[Finish]	-	\$230.00	\$230.00	\$259.00	\$314.00	-
#01 Lever Kit	371/373/375/378	050750	.[Finish]	-	\$230.00	\$230.00	\$259.00	\$314.00	-
#01 DT Lever Kit	373/375	050751	.[Finish]	-	\$230.00	\$230.00	\$259.00	\$314.00	-
#02 Lever Kit	371/373/375/378	050752	.[Finish]	-	\$230.00	\$230.00	\$259.00	\$314.00	-
#02 DT Lever Kit	373/375	050753	.[Finish]	-	\$230.00	\$230.00	\$259.00	\$314.00	-
#03 Lever Kit	371/373/375/378	050754	.[Finish]	-	\$230.00	\$230.00	\$259.00	\$314.00	-
#03 DT Lever Kit	373/375	050755	.[Finish]	-	\$230.00	\$230.00	\$259.00	\$314.00	-
#06 Lever Kit	371/373/375/378	050756	.[Finish]	-	\$230.00	\$230.00	\$259.00	\$314.00	-
#06 DT Lever Kit	373/375	050757	.[Finish]	-	\$230.00	\$230.00	\$259.00	\$314.00	-
#07 Lever Kit	371/373/375/378	050758	.[Finish]	-	\$230.00	\$230.00	\$259.00	\$314.00	-
#07 DT Lever Kit	373/375	050759	.[Finish]	-	\$230.00	\$230.00	\$259.00	\$314.00	-
#17 Lever Kit	371/373/375/378	050760	.[Finish]	-	\$230.00	\$230.00	\$259.00	\$314.00	-
#17 DT Lever Kit	373/375	050761	.[Finish]	-	\$230.00	\$230.00	\$259.00	\$314.00	-
#12 Lever RHR Kit	371/373/375/378	050762	.[Finish]	-	\$230.00	\$230.00	\$259.00	\$314.00	-
#12 DT Lever RHR Kit	373/375	050763	.[Finish]	-	\$230.00	\$230.00	\$259.00	\$314.00	-
#12 Lever LHR Kit	371/373/375/378	050764	.[Finish]	-	\$230.00	\$230.00	\$259.00	\$314.00	-
#12 DT Lever LHR Kit	373/375	050765	.[Finish]	-	\$230.00	\$230.00	\$259.00	\$314.00	-
LAT Lever Kit	360	051871	.[Finish]	-	\$230.00	\$230.00	\$259.00	\$314.00	-
LON Lever Kit	360	051873	.[Finish]	-	\$230.00	\$230.00	\$259.00	\$314.00	-
M51 Lever Kit	360	114810	.[Finish]	-	\$336.00	\$336.00	\$336.00	\$336.00	-
M51 Lever Kit	360	114812	.[Finish]	-	-	-	-	-	\$336.00
M52 Lever Kit	360	051920	.[Finish]	-	\$336.00	\$336.00	\$336.00	\$336.00	-
M52 Lever Kit	360	051922	.[Finish]	-	-	-	-	-	\$336.00
M53 Lever Kit	360	051928	.[Finish]	-	\$336.00	\$336.00	\$336.00	\$336.00	-
M53 Lever Kit	360	051930	.[Finish]	-	-	-	-	-	\$336.00
M54 Lever Kit	360	114826	.[Finish]	-	\$336.00	\$336.00	\$336.00	\$336.00	-
M54 Lever Kit	360	114828	.[Finish]	-	-	-	-	-	\$336.00

¹ 619 finish available with Series 35 and 98 controls, only.

PARTS AND ACCESSORIES

605	606	611	612	613	619	622	625	626	626AM	628	629
US3	US4	US9	US10	US10B	US15	US19	US26	US26D	US26DAM	US28	US32
630	630AM	643e	689	691	693	695	706	710	711	721	728
US32D	US32DAM	-	SP28	SPI0	SPBLK	SP313	SP4	313	315	US3A	US4A

360/370 SERIES CONTROLS

Description	Model	Specify		Non-finished	613 626	606	612	605, 619, ¹ 625, 693	629, 630
		Part number	Finish						
M55 Lever Kit	360	051936	.[Finish]	-	\$336.00	\$336.00	\$336.00	\$336.00	-
M55 Lever Kit	360	051938	.[Finish]	-	-	-	-	-	\$336.00
M56 Lever Kit	360	114822	.[Finish]	-	\$336.00	\$336.00	\$336.00	\$336.00	-
M56 Lever Kit	360	114824	.[Finish]	-	-	-	-	-	\$336.00
M57 Lever Kit	360	051914	.[Finish]	-	-	-	-	-	\$336.00
M61LH Lever Kit	360	114814	.[Finish]	-	\$336.00	\$336.00	\$336.00	\$336.00	-
M61LH Lever Kit	360	114816	.[Finish]	-	-	-	-	-	\$336.00
M61RH Lever Kit	360	114818	.[Finish]	-	\$336.00	\$336.00	\$336.00	\$336.00	-
M61RH Lever Kit	360	114820	.[Finish]	-	-	-	-	-	\$336.00
M62LH Lever Kit	360	051916	.[Finish]	-	-	-	-	-	\$336.00
M62RH Lever Kit	360	051918	.[Finish]	-	-	-	-	-	\$336.00
M63LH Lever Kit	360	114842	.[Finish]	-	\$336.00	\$336.00	\$336.00	\$336.00	-
M63LH Lever Kit	360	114844	.[Finish]	-	-	-	-	-	\$336.00
M63RH Lever Kit	360	114846	.[Finish]	-	\$336.00	\$336.00	\$336.00	\$336.00	-
M63RH Lever Kit	360	114848	.[Finish]	-	-	-	-	-	\$336.00
M81 Lever Kit	360	051924	.[Finish]	-	\$336.00	\$336.00	\$336.00	\$336.00	-
M81 Lever Kit	360	051926	.[Finish]	-	-	-	-	-	\$336.00
M82 Lever Kit	360	051932	.[Finish]	-	\$336.00	\$336.00	\$336.00	\$336.00	-
M82 Lever Kit	360	051934	.[Finish]	-	-	-	-	-	\$336.00
M83 Lever Kit	360	114830	.[Finish]	-	\$336.00	\$336.00	\$336.00	\$336.00	-
M83 Lever Kit	360	114832	.[Finish]	-	-	-	-	-	\$336.00
M84 Lever Kit	360	114850	.[Finish]	-	\$336.00	\$336.00	\$336.00	\$336.00	-
M84 Lever Kit	360	114852	.[Finish]	-	-	-	-	-	\$336.00
M85LH Lever Kit	360	114834	.[Finish]	-	\$336.00	\$336.00	\$336.00	\$336.00	-
M85LH Lever Kit	360	114836	.[Finish]	-	-	-	-	-	\$336.00
M85RH Lever Kit	360	114838	.[Finish]	-	\$336.00	\$336.00	\$336.00	\$336.00	-
M85RH Lever Kit	360	114840	.[Finish]	-	-	-	-	-	\$336.00
#03 SS Lever Kit	360	051861	.[Finish]	-	-	-	-	-	\$314.00
#06 SS Lever Kit	360	051863	.[Finish]	-	-	-	-	-	\$314.00
#17 SS Lever Kit	360	051865	.[Finish]	-	-	-	-	-	\$314.00
LAT SS Lever Kit	360	051867	.[Finish]	-	-	-	-	-	\$314.00
LON SS Lever Kit	360	051869	.[Finish]	-	-	-	-	-	\$314.00
Thumbturn Kit	374/376/377	050592	.[Finish]	-	\$220.00	\$220.00	\$220.00	\$340.00	-
Thumbturn Kit	360	050593	.[Finish]	-	\$220.00	\$220.00	\$220.00	\$340.00	-
Backplate	360	050595	-	\$23.00	-	-	-	-	-
Backplate LHR	371/3/4/5/6/7/8	050596	-	\$23.00	-	-	-	-	-
Backplate RHR	371/3/4/5/6/7/8	050597	-	\$23.00	-	-	-	-	-
Backplate LDT	373/375	050598	-	\$23.00	-	-	-	-	-

¹ 619 finish available with Series 35 and 98 controls, only.

PARTS AND ACCESSORIES

605	606	611	612	613	619	622	625	626	626AM	628	629
US3	US4	US9	US10	US10B	US15	US19	US26	US26D	US26DAM	US28	US32
630	630AM	643e	689	691	693	695	706	710	711	721	728
US32D	US32DAM	-	SP28	SPIO	SPBLK	SP313	SP4	313	315	US3A	US4A

360/370 SERIES CONTROLS

Description	Model	Specify		Non-finished	613 626	606	612 622 693	605 625
		Part number	Finish					
NL Cylinder Plate	371/3/4/5/6/7/8	050599	-	\$17.00	-	-	-	-
TL Cylinder Plate	371/3/4/5/6/7/8	050600	-	\$17.00	-	-	-	-
Cylinder Lock Nut & Washer	371/3/4/5/6/7/8	109111	-	\$23.00	-	-	-	-
Cylinder Locknut	360	050526	-	\$15.00	-	-	-	-
Cylinder Lock Pkg/2	371/3/4/5/6/7/8	090090	-	\$14.00	-	-	-	-
Cylinder Auxiliary Package	360	900622	-	\$31.00	-	-	-	-
Lever Adjustment Block	371/3/4/5/6/7/8	050576	-	\$14.00	-	-	-	-
Lever Bushing	360L	050579	-	\$14.00	-	-	-	-
Lever Bushing	371/373/375/378	050601	-	\$14.00	-	-	-	-
Lever Control Spring LHR Pkg/4	371/373/375/378	090091	-	\$17.00	-	-	-	-
Lever Control Spring RHR Pkg/4	371/373/375/378	090092	-	\$17.00	-	-	-	-
Lever Return Spring Pkg/2	360L/L-BE	090093	-	\$17.00	-	-	-	-
Lever Shaft Lock	371/373/375/378	050602	-	\$14.00	-	-	-	-
Lever Spindle	373	967480	-	\$14.00	-	-	-	-
Lever Stop Block	373/375	050603	-	\$14.00	-	-	-	-
Mounting Stud Pkg/2	360	090094	-	\$14.00	-	-	-	-
Mounting Stud Pkg/2	371/373/378	090095	-	\$14.00	-	-	-	-
Mounting Stud Pkg/2	374/376/377	090096	-	\$14.00	-	-	-	-
Cam - Input	360L/L-BE	050604	-	\$13.00	-	-	-	-
Cam - Output	360	050605	-	\$34.00	-	-	-	-
Cam - Vertical Rod	371/374/376/377	050606	-	\$31.00	-	-	-	-
Cam Retaining Screw (Pkg/4)	371/373/375/378	090097	-	\$14.00	-	-	-	-
Dogging Spring and Guide Kit	371/3/4/5/6/7/8	050607	-	\$14.00	-	-	-	-
Locking Member	360	050608	-	\$41.00	-	-	-	-
Mortise Adaptor	373/375	050609	-	\$51.00	-	-	-	-
Pin - Spirol 3/32 x 19/32 Pkg/4	373/375	090098	-	\$14.00	-	-	-	-
Shear Pin Kit	360	050611	-	\$14.00	-	-	-	-
Pine Tree Clip Pkg/10	360	090099	-	\$13.00	-	-	-	-
Rub Plate	374/377	050612	-	-	\$82.00	\$88.00	\$88.00	\$88.00
Short Arm Hex Wrench 1/8"	374/377	050613	-	\$15.00	-	-	-	-
Short Hex Key 3/32"	371/376	050614	-	\$14.00	-	-	-	-
Socket Set Screw 1/4-20 x 1/4	374/377	090100	-	\$14.00	-	-	-	-
Socket Set Screw 10-32 x 1/4 Pkg/10	360	090101	-	\$14.00	-	-	-	-
Spring - Locking Torsion	360	050615	-	\$11.00	-	-	-	-
Tailpiece	360	050587	-	\$12.00	-	-	-	-
Tailpiece Guide Pkg/10	360	050156	-	\$22.00	-	-	-	-
Tailpiece and screw pkg 2 1/4 - 2 3/4"	360	041000	-	\$199.00	-	-	-	-
Tailpiece and screw pkg 2 3/4 - 3 1/4"	360	041001	-	\$199.00	-	-	-	-
Tailpiece and screw pkg 3 1/4 - 3 3/4"	360	041002	-	\$199.00	-	-	-	-
Tailpiece and screw pkg 3 3/4 - 4 1/4"	360	041003	-	\$199.00	-	-	-	-

PARTS AND ACCESSORIES

605	606	611	612	613	619	622	625	626	626AM	628	629
US3	US4	US9	US10	US10B	US15	US19	US26	US26D	US26DAM	US28	US32
630	630AM	643e	689	691	693	695	706	710	711	721	728
US32D	US32DAM	-	SP28	SP10	SPBLK	SP313	SP4	313	315	US3A	US4A

360/370 SERIES CONTROLS

Description	Model	Specify		Non-finished	613 626	606	612 622 693	605 625
		Part number	Finish					
Thumbturn Control Spring & Washer Kit	374/376/377	050616	-	\$17.00	-	-	-	-
Thumbturn Sleeve	374/376/377	050619	-	\$43.00	-	-	-	-
Washer - Bearing	371/3/4/5/6/7/8	050621	-	\$31.00	-	-	-	-
Washer - Locking Pkg/10	371/373/375	090102	-	\$14.00	-	-	-	-
Washer - Wave Spring Pkg/10	360/371/373/375/378	090103	-	\$13.00	-	-	-	-
Screw Package 1 3/4" Dr	371/373/378	900807	.[Finish]	-	\$23.00	\$23.00	\$23.00	\$23.00
Screw Package 2 1/4" Dr	371/373/378	900808	.[Finish]	-	\$31.00	\$31.00	\$31.00	\$31.00
Screw Package 1 3/4" Dr	374/376/377	900809	.[Finish]	-	\$23.00	\$23.00	\$23.00	\$23.00
Screw Package 2 1/4" Dr	374/376/377	900810	.[Finish]	-	\$31.00	\$31.00	\$31.00	\$31.00
Screw Package 1 3/4" Dr	375	900883	.[Finish]	-	\$23.00	\$23.00	\$23.00	\$23.00
Screw Package 2 1/4" Dr	375	900884	.[Finish]	-	\$31.00	\$31.00	\$31.00	\$31.00
WDC Cover Plate 1 3/4"	376T-WDC	900555	.[Finish]	-	\$52.00	\$68.00	\$124.00	\$124.00
WDC Cover Plate 2 1/4"	376T-WDC	900556	.[Finish]	-	\$52.00	\$68.00	\$124.00	\$124.00

Z2 SERIES
 33A/35A SERIES
 55 SERIES
 88 SERIES
 98/99 SERIES
 XP98/XP99 SERIES
 94/95 SERIES
 GUARD-X SERIES
 ACCESSORIES / PARTS
 ELECTRICAL / PARTS

CYLINDER CONTROLS

605	606	611	612	613	619	622	625	626	626AM	628	629
US3	US4	US9	US10	US10B	US15	US19	US26	US26D	US26DAM	US28	US32
630	630AM	643e	689	691	693	695	706	710	711	721	728
US32D	US32DAM	-	SP28	SP10	SPBLK	SP313	SP4	313	315	US3A	US4A

THUMBTURNS

Description	Specify		613	612	606	605	619
	Model number	Finish	626 693			625 643e	
Thumbturn - 33/35A Rim	360T	.[Finish]	\$782.00	\$842.00	\$674.00	\$842.00	\$842.00
Thumbturn, Blank Escutcheon - 33/35A Rim	360T-BE	.[Finish]	\$739.00	\$799.00	\$631.00	\$799.00	\$799.00
Thumbturn - 33/3527A, 98/9927	374T	.[Finish]	\$782.00	\$842.00	\$674.00	\$842.00	\$842.00
Thumbturn, Blank Escutcheon - 33/3527A, 98/9927	374T-BE	.[Finish]	\$739.00	\$799.00	\$631.00	\$799.00	\$799.00
Thumbturn - 33/3547A, 5547, 8847	376T	.[Finish]	\$782.00	\$842.00	\$674.00	\$842.00	\$842.00
Thumbturn, Blank Escutcheon - 33/3547A, 5547, 8847	376T-BE	.[Finish]	\$739.00	\$799.00	\$631.00	\$799.00	\$799.00
Thumbturn, WD - 33A/35A/55/98/9947WDC	376WDC-T	.[Finish]	\$782.00	\$842.00	\$674.00	\$842.00	\$842.00
Thumbturn, Blank Escut., WD - 33A/35A/55/98/9947WDC	376WDC-T-BE	.[Finish]	\$739.00	\$799.00	\$631.00	\$799.00	\$799.00
Thumbturn - 8827, WS98/9927	377T	.[Finish]	\$783.00	\$843.00	\$675.00	\$843.00	-
Thumbturn, Blank Escutcheon - 8827	377T-BE	.[Finish]	\$739.00	\$799.00	\$631.00	\$799.00	-

OPTIONS

ANTI-MICROBIAL FINISH	Specify (Suffix)	Price adjustment
Antimicrobial Coating available in 626, use suffix-AM when ordering. Example 626-AM	AM	\$34.00

SOLID WOOD OR COMPOSITE DOORS	Specify (Suffix)	Price adjustment
Required with 370 series lever control trim when used on solid wood or composite doors	10WDA	\$56.00
Required with 360 series lever control trim when used on solid wood or composite doors	33-WDA	\$56.00

ELECTRIC UNLOCKING	Specify (Suffix)	Price adjustment
<ul style="list-style-type: none"> E360/E370 Cylinder Controls - Electric Unlocking of outside trim for use on all vertical device types. Must be furnished T-BE or TL-BE functions only Prefix trim "E" (example E373) Specify Fail Safe (FS) and Fail Secure (FSE). 24VDC furnished standard, 12VDC available through special order ☒ 	E	\$661.00

☒ Consult factory for lead time.

BLANK PLATES

Description	Specify		613	612	606	605	619
	Model number	Finish	626 693			625 643e	
Blank Plate - 33A/35A Rim, 33/3527A, 33/3547A	360EO	.[Finish]	\$364.00	\$381.00	\$315.00	\$392.00	\$392.00
Blank Plate - 88, 8827, 8875	373EO	.[Finish]	\$364.00	\$381.00	\$315.00	\$392.00	-
Blank Plate - 33/3527A, 98/9927	374EO	.[Finish]	\$364.00	\$381.00	\$315.00	\$392.00	\$392.00
Blank Plate - 5547, 8847	376EO	.[Finish]	\$364.00	\$381.00	\$315.00	\$392.00	-

COVER PLATES, CYLINDERS AND GLASS BEAD KITS

605	606	611	612	613	619	622	625	626	626AM	628	629
US3	US4	US9	US10	US10B	US15	US19	US26	US26D	US26DAM	US28	US32
630	630AM	643e	689	691	693	695	706	710	711	721	728
US32D	US32DAM	-	SP28	SP10	SPBLK	SP313	SP4	313	315	US3A	US4A

COVER PLATES								
Description	Specify		689 695	613 626	630	612	606	605, 693, 625, 619, 622
	Model number	Finish						
370 Series Controls on Wood Doors	10WDA	.[Finish]	—	\$56.00	—	\$56.00	\$56.00	\$56.00
360 Series Controls on Wood Doors	33A-WDA	.[Finish]	—	\$56.00	—	\$56.00	\$56.00	\$56.00
5547WDC Scalp Plate	5547WDC	.[Finish]	—	\$171.00	\$171.00	\$176.00	\$171.00	\$179.00
9947WDC Scalp Plate	9947WDC	.[Finish]	—	\$69.00	\$43.00	\$69.00	\$69.00	\$133.00
33A/35A/98/9950WDC Cover Plate	50WDC	-	\$69.00	—	\$69.00	\$69.00	\$69.00	\$69.00
22 Rim Device	229	-	\$111.00	—	—	—	—	—
5575 Device on Wood Doors	589	.[Finish]	—	\$170.00	—	\$229.00	\$198.00	\$212.00
88 Rim Device	882	.[Finish]	—	\$166.00	—	—	\$144.00	\$185.00
88 Rim/8827 Pairs with ANSI 161 door cutout	887	.[Finish]	—	\$166.00	—	—	\$144.00	—
8875 or 8827 with ANSI 161 door cutout	888	.[Finish]	—	\$166.00	—	—	\$144.00	—
373L Control with Sexbolts - specify device type R, M or V	889	.[Finish]	—	\$250.00	—	\$254.00	\$238.00	\$263.00
98/99 Rim Device	997	-	\$111.00	—	—	\$111.00	\$111.00	—
994L Trim retrofit Plate	998	.[Finish]	—	\$101.00	—	\$79.00	\$79.00	\$130.00

CYLINDERS			
Description	Specify		606, 612, 613, 626
	Model number	Finish	
Mortise 1-1/4" - 20-001 XQ11-949	3215	.[Finish]	\$96.00
Rim	3216	.[Finish]	\$96.00

Note: Custom keying is not available

GLASS BEAD KITS			
Description	Specify		Sprayed finish to match 606, 612, 622, 689, 695
	Model number	Finish	
1/4" 98/99 Rim/Mortise	98/99GBK-R/M	.[Finish]	\$74.00
1/4" 98/99 Concealed Vertical	98/99GBK-CV	.[Finish]	\$74.00
1/4" 98/99 Concealed Vertical for Wood Doors	98/99GBK-CV-WDC	.[Finish]	\$74.00
1/4" 98/99 Surface Vertical	98/99GBK-SV	.[Finish]	\$105.00
1/4" 98/99 Rim used with 499-F Strike	98/99GBK-R-499F	.[Finish]	\$105.00
1/4" XP98/99 Rim/Mortise	XP98/99GBK-R/M	.[Finish]	\$119.00
1/4" XP98/99 Rim used with 954 Strike	XP98/999GBK-R-954	.[Finish]	\$119.00
1/4" 33A/35A Rim	33A/35A-GBK-R	.[Finish]	\$74.00
1/4" 33A/35A Surface Vertical	33A/35A-GBK-SV	.[Finish]	\$105.00
1/4" 33A/35A Concealed Vertical	33A/35A-GBK-CV	.[Finish]	\$74.00
1/4" 22 Rim	22GBK-R	.[Finish]	\$74.00
1/4" 22 Surface Vertical	22GBK-SV	.[Finish]	\$105.00
1/4" 22 Rim used with 499-F Strike	22GBK-R-499F	.[Finish]	\$105.00

22 SERIES
 33A/35A SERIES
 55 SERIES
 88 SERIES
 98/99 SERIES
 XP98/XP99 SERIES
 94/95 SERIES
 GUARD-X SERIES
 ACCESSORIES / PARTS
 ELECTRICAL / PARTS

MULLIONS

605	606	611	612	613	619	622	625	626	626AM	628	629
US3	US4	US9	US10	US10B	US15	US19	US26	US26D	US26DAM	US28	US32
630	630AM	643e	689	691	693	695	706	710	711	721	728
US32D	US32DAM	-	SP28	SP10	SPBLK	SP313	SP4	313	315	US3A	US4A

STEEL MULLIONS

Description	For openings up to:	With KR option for openings up to:	Specify		689 695
			Model number	Finish	
Prepped for two 1606 Strikes - If 1606 strikes are not specified on your order, two 1606 strikes will be added per mullion. Each 1606 strike is \$78 list.	7' 2"	7' 6"	1654	.[Finish]	\$639.00
	8' 2"	8' 6"			\$691.00
	10' 2"	10' 6"			\$799.00
Prepped for two 4263 Monitor Strikes	7' 2"	7' 6"	4754	.[Finish]	\$884.00
	8' 2"	8' 6"			\$935.00
	10' 2"	10' 6"			\$1,037.00
Prepped for one 299 strike and one 6111 Electric Strike. Advise Handing of Electric Strike Prep.	7' 2"	7' 6"	4854	.[Finish]	\$884.00
	8' 2"	8' 6"			\$935.00
	10' 2"	10' 6"			\$1,037.00
Prepped for two 299 Strikes	7' 2"	7' 6"	4954	.[Finish]	\$639.00
	8' 2"	8' 6"			\$691.00
	10' 2"	10' 6"			\$799.00
Prepped for two 909 Strikes, for the XP device.	7' 2"	7' 6"	4954-XP	.[Finish]	\$639.00
	8' 2"	8' 6"			\$691.00
	10' 2"	10' 6"			\$799.00
Prepped for one 499F and one 6111 Electric Strike or one 268 Strike and one 6111 Electric Strike. Advise handing of Electric Strike Prep.	7' 3"	7' 5"	9854 ¹	.[Finish]	\$1,233.00
	8' 3"	8' 5"			\$1,284.00
	10' 3"	10' 5"			\$1,390.00
Prepped for two 499F or 268 Strikes	7' 3"	7' 5"	9954 ¹	.[Finish]	\$991.00
	8' 3"	8' 5"			\$1,041.00
	10' 3"	10' 5"			\$1,145.00
Prepped for two 954 Strikes, for the XP device.	7' 3"	7' 5"	9954-XP	.[Finish]	\$991.00
	8' 3"	8' 5"			\$1,041.00
	10' 3"	10' 5"			\$1,145.00
Hurricane impact-rated Mullion, with two 468 strike	8'0"		HH9954	.[Finish]	\$1,748.00

¹ When used with 22, 98 or 99 Series Rim Fire Devices or 98/9957-F Devices, and 499F strikes are not ordered with devices, two 499F strikes per 9954 and one per 9854 will be added. Each 499F strike is \$194 list.

ALUMINUM MULLIONS - FURNISHED WITH STABILIZERS AND WEATHERSTRIPPING

Description	For openings up to:	Specify		606, 612, 628, 710	711
		Model number	Finish		
Prepped for two 299 Strikes	7' 2"	5654	.[Finish]	\$1,481.00	\$1,779.00
	8' 2"			\$1,584.00	\$1,881.00
	10' 2"			\$1,881.00	\$2,226.00
Prepped for two 909 Strikes, for the XP device.	7' 2"	5654-XP	.[Finish]	\$1,481.00	\$1,779.00
	8' 2"			\$1,584.00	\$1,881.00
	10' 2"			\$1,881.00	\$2,226.00
Prepped for a 1408 Double Strike. Price includes strike. Note: If 5754 is ordered w/device - Specify device L/strike	7' 2"	5754	.[Finish]	\$1,776.00	\$2,075.00
	8' 2"			\$1,872.00	\$2,175.00
	10' 2"			\$2,075.00	\$2,181.00

Reference notes:

- Von Duprin Mullions are furnished for flat sills.
- Strikes are not included except where indicated.
- When required, strikes should be ordered with devices.
- Mullions are furnished standard for 7'0 doors when door height is not specified.
- Blank Mullions (without strike preparation) are available at the same price as standard Mullions.
- The 9854 and 9954 are U.L. Fire approved for heights up to 8'0" with 22-F and 88-F Rim Device. For door heights over 8'0" mullion is furnished less U.L. label.
- The 9854 and 9954 are U.L. Fire approved for heights up to 10'0" with 98/99-F Rim Device. For door heights over 10'0" mullion is furnished less U.L. label.
- ADA centerline height of 37" is available at no additional charge, must be specified.
- Special Centerlines (other than 39-11/16") or Special Length mullions, see page 18 for pricing.

MULLIONS

605	606	611	612	613	619	622	625	626	626AM	628	629
US3	US4	US9	US10	US10B	US15	US19	US26	US26D	US26DAM	US28	US32
630	630AM	643e	689	691	693	695	706	710	711	721	728
US32D	US32DAM	-	SP28	SP10	SPBLK	SP313	SP4	313	315	US3A	US4A

STEEL MULLION OPTIONS AND ACCESSORIES

Description	Specify		689 695
	Model number	Finish	
Keyed Removable option - Prefix Mullion model with "KR" KR1654/4954 List Add to Mullion price	KR	.[Finish]	\$536.00
Keyed Removable option - Prefix Mullion model with "KR" KR98/9954/4754/4854 List Add to Mullion price	KR	.[Finish]	\$590.00
Keyed Removable Kit for 1654 and 4954 Mullions	KR54	-	\$536.00
Keyed Removable Kit for 98/9954/4754/4854 Mullion	KR54-F	-	\$590.00
Wall Mounted Storage Kit "specify part number 050581"	MT54	-	\$171.00
Mullion Stabilizers (set of four, 2 attaches to the mullion and 2 to the door)	154	-	\$104.00

PARTS AND ACCESSORIES

ALUMINUM MULLION ACCESSORIES

	Specify	Price adjustment
Mullion Angle Bracket - For Narrow Transom Bars (all finishes)	050092	\$62.00

MULLIONS

Description	Specify		Non-Finished	689 695	606, 612, 628, 710
	Part number	Finish			
5654/5754 Fitting Set	050130	.[Finish]	-	-	\$207.00
5654/5754 Top Fitting & Cover	050135	.[Finish]	-	-	\$126.00
KR54 Retrofit Kit	050168	.[Finish]	-	\$536.00	-
KR54-F Retrofit Kit	050169	.[Finish]	-	\$590.00	-
5654/5754 Bottom Fitting	050190	.[Finish]	-	-	\$126.00
9954 Fitting Set	050241	.[Finish]	-	\$391.00	-
1654/4954 Fitting Set	050330	.[Finish]	-	\$151.00	-
1654/4954 Top Fitting & Cover	050335	.[Finish]	-	\$74.00	-
4754/4854 Fitting Set	050371	.[Finish]	-	\$306.00	-
4754/4854 Top Electrical Fitting & Cover	050381	.[Finish]	-	\$233.00	-
9854 Top Mullion Fitting Kit	050383	.[Finish]	-	\$233.00	-
1654/4754/4854/4954 Bottom Fitting	050390	.[Finish]	-	\$72.00	-
9854/9954 Top Fitting & Cover	050391	.[Finish]	-	\$189.00	-
98/9954 Bottom Fitting & Cover	050392	.[Finish]	-	\$189.00	-
KR Mullion Cylinder Lock Nut	050526	-	\$15.00	-	-
Weatherstripping (10') Use 2 Per Mullion	050580	-	\$32.00	-	-
Mullion (Top) Screw Package	900400	-	\$20.00	-	-
Mullion (Bottom) Screw Package	900402	-	\$27.00	-	-
KR1654/4954 Mullion Mounting Package	900409	.[Finish]	-	\$77.00	-
KR9854/9954 Mullion Mounting Package	900410	.[Finish]	-	\$64.00	-
9954 (Bottom) Screw Package	900411	-	\$26.00	-	-
9954 (Top) Screw Package	900413	-	\$26.00	-	-

PARTS AND ACCESSORIES

605	606	611	612	613	619	622	625	626	626AM	628	629
US3	US4	US9	US10	US10B	US15	US19	US26	US26D	US26DAM	US28	US32
630	630AM	643e	689	691	693	695	706	710	711	721	728
US32D	US32DAM	-	SP28	SP10	SPBLK	SP313	SP4	313	315	US3A	US4A

MULLIONS

Description	Specify		Non-Finished	689 695	606, 612, 628, 710
	Part number	Finish			
4754/4854/4954 Top Fitting Cover	961047	.[Finish]	-	\$23.00	-
5654 Mullion Edging - 7'	965712	.[Finish]	-	-	\$70.00
5654 Mullion Edging - 8'	965713	.[Finish]	-	-	\$77.00
5654 Mullion Edging - 10'	965714	.[Finish]	-	-	\$86.00
9954 Top Fitting Cover	968645	.[Finish]	-	\$23.00	-
KR Inner Mullion Back Cover Plate	971187	.[Finish]	-	\$26.00	-
KR Shim Plate	971212	-	\$13.00	-	-
KR-F Shim Plate	971313	.[Finish]	-	\$46.00	-
KR9954 Top Fitting	971312	.[Finish]	-	\$128.00	-
KR9854/9954 Fusible Spacer	971316	.[Finish]	-	\$68.00	-
KR Mullion Cylinder Locking Washer	971328	-	\$19.00	-	-
KR1654/4954 Top Fitting	971340	.[Finish]	-	\$111.00	-
MT54 Wall Mounted Storage Kit	050581	.[Finish]	-	\$171.00	-
Female Receptacle Wire Assy	105988	-	\$82.00	-	-
Male Receptacle Wire Assy	105987	-	\$96.00	-	-
Mullion Stabilizers	050054	.[Finish]	-	\$101.00	-

ROD AND LATCH GUARDS

ROD AND LATCH GUARD - FOR USE WITH ALL VON DUPRIN SURFACE VERTICAL ROD DEVICES

Description	Specify			630
	Model number	Part number	Finish	
Rod and Latch Guard	RG-27	050061-32 (RHR), 050062-32 (LHR)	.[Finish]	\$499.00
Rod and Latch Guard Extended 3' Door	RG-27-3	050261-32 (RHR), 050262-32 (LHR)	.[Finish]	\$1,038.00
Rod and Latch Guard Extended 4' Door	RG-27-4	050263-32 (RHR), 050264-32 (LHR)	.[Finish]	\$1,344.00
Rod Guard Only	RGO	050066-32 (NON-HANDED)	.[Finish]	\$311.00
Latch Guard Only	LGO	050067-32 (RHR), 050068-32 (LHR)	.[Finish]	\$182.00
Latch Guard Only Extended 3' Door	LGO-3	050265-32 (RHR), 050266-32 (LHR)	.[Finish]	\$740.00
Latch Guard Only Extended 4' Door	LGO-4	050267-32 (RHR), 050268-32 (LHR)	.[Finish]	\$1,038.00
Latch Guard Only Extended, Windstorm, 3'	WS-LGO-3	117155-32 (RHR), 117157-32 (LHR)	.[Finish]	\$1,178.00
Latch Guard Only Extended, Windstorm, 4'	WS-LGO-4	117516-32 (RHR), 117518-32 (LHR)	.[Finish]	\$1,393.00

Note: Specify Handing.

MORTISE LOCKS

605	606	611	612	613	619	622	625	626	626AM	628	629
US3	US4	US9	US10	US10B	US15	US19	US26	US26D	US26DAM	US28	US32
630	630AM	643e	689	691	693	695	706	710	711	721	728
US32D	US32DAM	-	SP28	SP10	SPBLK	SP313	SP4	313	315	US3A	US4A

MORTISE LOCKS FOR PANIC AND FIRE-RATED MORTISE LOCK DEVICES

Description	Specify		630	605, 606, 612, 613, 622, 625
	Model number	Finish		
Standard Mortise Lock	7500	.[Finish]	\$708.00	\$730.00
Double Cylinder Mortise Lock	7500-2	.[Finish]	\$924.00	\$946.00
INPACT Device Mortise Lock	7500-IN	.[Finish]	\$880.00	\$903.00

PARTS AND ACCESSORIES

7500 SERIES MORTISE LOCK

Description	Specify		Non-finished	630	606 613 622	612	605	629
	Part number	Finish						
E7500 Solenoid Replacement Kit 12VDC FSE*	050212	-	\$260.00	-	-	-	-	-
E7500 Solenoid Replacement Kit 12VDC FS*	050213	-	\$260.00	-	-	-	-	-
E7500 Solenoid Replacement Kit 24VDC FSE*	050214	-	\$260.00	-	-	-	-	-
E7500 Solenoid Replacement Kit 24VDC FS*	050215	-	\$260.00	-	-	-	-	-
E/SS7500 Female Terminal	050540	-	\$14.00	-	-	-	-	-
7500 Auxiliary Bolt Link Sub-Assembly	109347	-	\$42.00	-	-	-	-	-
E7500 Hook-up Wire Assy	114140	-	\$69.00	-	-	-	-	-
SS7500 Wire Harness Switch Sub-Assembly	114294	-	\$111.00	-	-	-	-	-
7500 Latchbolt and Faceplate Sub-Assembly	109773	-	\$76.00	-	-	-	-	-
E7500 Switch Connector Assembly	110744	-	\$139.00	-	-	-	-	-
7500-2 Cylinder Plug Assembly	111943	-	\$202.00	-	-	-	-	-
7500 Lock Mounting Pkg	900532	.[Finish]	-	\$14.00	\$14.00	\$14.00	\$14.00	-
7500 Scalp Plate - 8-32 x 3/8" FPHMS	963080	.[Finish]	-	\$14.00	\$14.00	\$14.00	\$14.00	-
7500 Hsg. Cover - 8-32 x 3/8" UFPHMS	964330	-	\$14.00	-	-	-	-	-
7500 Housing 8-32 x 3/8" PPH TF	964390	-	\$11.00	-	-	-	-	-
7500 Cyl. Set - 8-32 x 2" Fill SHMS	963954	-	\$14.00	-	-	-	-	-
#8 SAE Flat Washer	963984	-	\$14.00	-	-	-	-	-
E7500 FSE Roll Pin - 3/32 x 9/16"	964035	-	\$14.00	-	-	-	-	-
7500 Auxiliary Bolt	968668	-	\$57.00	-	-	-	-	-
7500 Deadlocking Spring	968748	-	\$14.00	-	-	-	-	-
7500 Trim Bolt Retractor	968761	-	\$14.00	-	-	-	-	-
7500 Thumb Latch Lift	968763	-	\$14.00	-	-	-	-	-
7500 Knob Cam	968765	-	\$43.00	-	-	-	-	-
7500 Scalp Plate	968766	.[Finish]	-	\$138.00	-	-	-	\$207.00
7500 Scalp Plate	970872	.[Finish]	-	-	\$142.00	\$142.00	\$207.00	-
E/SS7500 Switch Insulator	968770	-	\$14.00	-	-	-	-	-
7500 Deadlock Release Arm	968773	-	\$31.00	-	-	-	-	-
7500 Auxiliary Bolt Spring	968935	-	\$14.00	-	-	-	-	-
7500 Latchbolt Collar	968939	-	\$30.00	-	-	-	-	-

*For Mortise Lock shipped after 1992. For Mortise Locks shipped before 1992, entire Lock must be replaced

PARTS AND ACCESSORIES

605	606	611	612	613	619	622	625	626	626AM	628	629
US3	US4	US9	US10	US10B	US15	US19	US26	US26D	US26DAM	US28	US32
630	630AM	643e	689	691	693	695	706	710	711	721	728
US32D	US32DAM	-	SP28	SP10	SPBLK	SP313	SP4	313	315	US3A	US4A

7500 SERIES MORTISE LOCK

Description	Specify		Non-finished	630	606 613 622	612	605	629
	Part number	Finish						
7500 Latch Return Spring	969089	-	\$14.00	-	-	-	-	-
E7500 FSE Torsion Spring	969107	-	\$14.00	-	-	-	-	-
7500 Trim Lock Slide Spring	969364	-	\$14.00	-	-	-	-	-
7500 Latch Return Spring Guide	969610	-	\$14.00	-	-	-	-	-
7500 Trim Lock Spring Guide	970188	-	\$14.00	-	-	-	-	-
7500 Crossbar Input Arm	970318	-	\$30.00	-	-	-	-	-
E7500 FS Trim Lock Slide Spring	970546	-	\$14.00	-	-	-	-	-
7500 Stem Support	970735	-	\$14.00	-	-	-	-	-
E7500 Lever Screw	970861	-	\$17.00	-	-	-	-	-
E7500 Lever Spacer	970862	-	\$14.00	-	-	-	-	-
E7500 FS Trim Lock Lever	972549	-	\$15.00	-	-	-	-	-
E7500 Solenoid Spring	971320	-	\$13.00	-	-	-	-	-
7500 Housing Cover	971822	-	\$54.00	-	-	-	-	-
7500 Trim Lock Actuator	968793	-	\$14.00	-	-	-	-	-
7500-2 Trim Lock Actuator	970531	-	\$33.00	-	-	-	-	-
7500-IN Rod Connector	971832	-	\$82.00	-	-	-	-	-
6000 Strike/E/SS7500 Switch CON Adapter Harness	106181	-	\$33.00	-	-	-	-	-

*For Mortise Lock shipped after 1992. For Mortise Locks shipped before 1992, entire Lock must be replaced

237 TWO POINT LATCH

237 TWO POINT LATCH

Function	Push	Pull	Specify		613, 626	612	606	605, 625
			Model number	Finish				
OUTSWING DOOR (RHR AND LHR)								
Exit Only	237 BE	None	237EO	.[Finish]	\$2,949.00	\$2,949.00	\$2,831.00	\$3,016.00
Class room	237 BE	378 w/cyl	237L	.[Finish]	\$3,730.00	\$3,776.00	\$3,507.00	\$3,866.00
Passage	237 BE	378 BE	237L-BE	.[Finish]	\$3,693.00	\$3,744.00	\$3,460.00	\$3,821.00
Storeroom	237 BE	378 NL	237L-NL	.[Finish]	\$3,730.00	\$3,776.00	\$3,507.00	\$3,866.00
INSWING DOOR (RH AND LH)								
Exit Only	None	237 BE	237EO	.[Finish]	\$2,949.00	\$2,949.00	\$2,831.00	\$3,016.00
Class room	378 w/cyl	237 BE	237L	.[Finish]	\$3,730.00	\$3,776.00	\$3,507.00	\$3,866.00
Passage	378 BE	237 BE	237L-BE	.[Finish]	\$3,693.00	\$3,744.00	\$3,460.00	\$3,821.00
Storeroom	378 NL	237 BE	237L-NL	.[Finish]	\$3,730.00	\$3,776.00	\$3,507.00	\$3,866.00

NOTES:

- Price includes 304L Strike. Cylinders are not included.
- Can not be used on doors requiring panic or fire exit hardware.
- Windstorm-rated 237 outswing only
- If cylinder is required on push side, add suffix "C" to model #. (e.g. 237EO-C)
- Cylinder (mortise 3215) not included in pricing.
- The #06 Lever is furnished standard.
- Optional lever designs, #03 and #17 are available at no additional charge

237 TWO POINT LATCH

605	606	611	612	613	619	622	625	626	626AM	628	629
US3	US4	US9	US10	US10B	US15	US19	US26	US26D	US26DAM	US28	US32
630	630AM	643e	689	691	693	695	706	710	711	721	728
US32D	US32DAM	-	SP28	SP10	SPBLK	SP313	SP4	313	315	US3A	US4A

- UL Listing: Two-and Three-point Locks and Latches (for Fire Doors) – UL 10 C.
- Rating: 3HR Pairs (Double Egress), 90 Min. Pairs (Swing Same Direction), Door Size: 8'0 x 8'0 Pairs (Hollow Metal only)
- Windstorm Rating: UL-FEMA 320 and 361 certified: 4'0 x 8'0 Single Doors (Non-fire-rated) Hollow Metal,
- 8'0 x 8'0 Pairs Hollow Metal. UL –ANSI/ICC 500 certified for F5 Tornado applications.
- These products are listed with Steelcraft PW14 Series door for Tornado Listings.

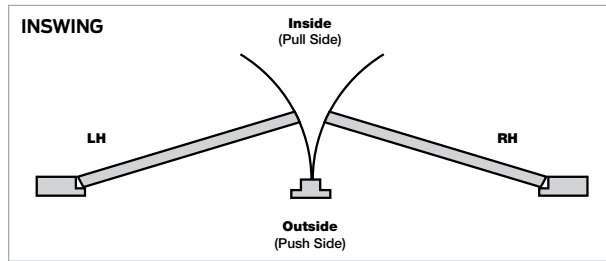
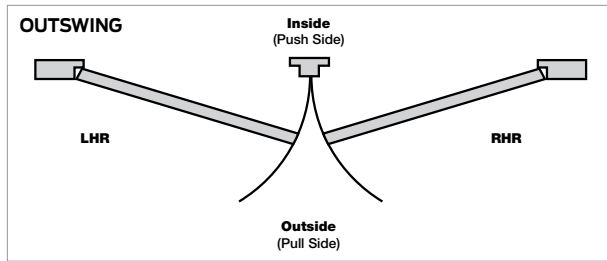

NOMENCLATURE – HOW TO ORDER

Model	Handing	Lever style	Finish
1	2	3	4
237EO -	RHR -	06 -	626

1 Model	
EO	Exit Only EO
L	Lever (classroom)
L-BE	Lever - blank escutcheon
L-NL	Lever, rigid - night latch

2 Handing	
LH	Left hand
RH	Right hand

2 Handing	
LHR	Left hand reverse
RHR	Right hand reverse

3 Lever style	
06	Standard default
03	
17	

4 Finish	
605	Bright Brass
606	Satin Brass
612	Satin Bronze
613	Oil Rubbed Bronze
625	Bright Chrome
626	Satin Chrome

PARTS AND ACCESSORIES

237 TWO POINT LATCH								
Description	Specify		Non-finished	630	613	612	606	629
	Part number	Finish						
237 Top Rod Assembly	112845	.[Finish]	-	\$503.00	\$512.00	\$463.00	\$580.00	\$560.00
237 Bottom Rod Assembly	112844	-	\$151.00	-	-	-	-	-
237 Mounting Plate Package	112835	.[Finish]	-	\$12.00	\$16.00	\$16.00	\$41.00	\$12.00

22 SERIES
 33A/35A SERIES
 55 SERIES
 88 SERIES
 98/99 SERIES
 XP98/XP99 SERIES
 94/95 SERIES
 GUARD-X SERIES
 ACCESSORIES / PARTS
 ELECTRICAL / PARTS

EXTENSION ROD KITS

605	606	611	612	613	619	622	625	626	626AM	628	629
US3	US4	US9	US10	US10B	US15	US19	US26	US26D	US26DAM	US28	US32
630	630AM	643e	689	691	693	695	706	710	711	721	728
US32D	US32DAM	-	SP28	SP10	SPBLK	SP313	SP4	313	315	US3A	US4A

EXTENSION ROD KITS - ALL FINISHES	Specify	Price adjustment
12" Extension Rod for 8827	ER-12-88	\$31.00
24" Extension Rod for 8827	ER-24-88	\$31.00
36" Extension Rod for 2227, 3327A, 3527A, 9827, 9857, 9927, 9957	ER-36-22/33A/99	\$31.00
12" Extension Rod for WS98/9927	ER-12-WS	\$31.00
Adjustable Extension Rod, over 8' up to 10' for 5547, 5547WDC, 8847	ER-ADJ10-55/88	\$31.00
Adjustable Extension Rod, 8'4" - 10' for 3347A, 3348A, 3547A, 3548A, 9847, 9847WDC, 9848, 9947, 9947WDC, 9948	ER-ADJ10-33A/99	\$31.00
Adjustable Extension Rod, over 8' up to 9'8" for 9447, 9547	ER-ADJ9.8-94	\$31.00

EXTENSION ROD KITS (FOR NON-STANDARD DOOR HEIGHTS)										
Description	Specify		Non-finished	619 626 630	710 613	612	606	605 625 629	711	643e 693
	Model number	Finish								
36" Extension Rod for 8827	ER-36-88	.[Finish]	—	\$96.00	\$146.00	\$107.00	\$92.00	\$327.00	—	\$327.00
48" Extension Rod for 8827	ER-48-88	.[Finish]	—	\$111.00	\$162.00	\$130.00	\$107.00	\$343.00	—	\$343.00
60" Extension Rod for 3327A, 3527A	ER-60-33A	.[Finish]	—	\$289.00	\$289.00	\$335.00	\$327.00	\$348.00	\$348.00	—
60" Extension Rod for 9827, 9857, 9927, 9957	ER-60-99	.[Finish]	—	\$149.00	\$149.00	\$277.00	\$182.00	\$291.00	\$291.00	—
Adjustable Extension Rod, 10' - 11'8" for 3347A, 3547A, 9847, 9847WDC, 9848, 9947, 9947WDC, 9948	ER-ADJ11.8-33A/99	-	\$103.00	—	—	—	—	—	—	—
Adjustable Extension Rod 11'8" - 13'4" for 3347A, 3547A, 9847, 9847WDC, 9848, 9947, 9947WDC, 9948	ER-ADJ13.4-33A/99	-	\$115.00	—	—	—	—	—	—	—
Adjustable Extension Rod, 13'4" - 15' for 3347A, 3547A, 9847, 9847WDC, 9848, 9947, 9947WDC, 9948	ER-ADJ15-33A/99	-	\$115.00	—	—	—	—	—	—	—
Adjustable Extension Rod 10' - 12' for 5547	ER-ADJ12-5547	-	\$102.00	—	—	—	—	—	—	—
Adjustable Extension Rod 12' - 14' for 5547	ER-ADJ14-5547	-	\$102.00	—	—	—	—	—	—	—
Adjustable Extension Rod, 14' - 16' for 5547	ER-ADJ16-5547	-	\$102.00	—	—	—	—	—	—	—
Adjustable Extension Rod 10' - 12' for 5547WDC	ER-ADJ12-5547WDC	-	\$224.00	—	—	—	—	—	—	—
Adjustable Extension Rod 12' - 14' for 5547WDC	ER-ADJ14-5547WDC	-	\$224.00	—	—	—	—	—	—	—
Adjustable Extension Rod, 14' - 16' for 5547WDC	ER-ADJ16-5547WDC	-	\$224.00	—	—	—	—	—	—	—
Adjustable Extension Rod 10' - 12' for 5547-F, 8847-F	ER-ADJ12-5547F	-	\$215.00	—	—	—	—	—	—	—
Adjustable Extension Rod 12' - 14' for 5547-F, 8847-F	ER-ADJ14-5547F	-	\$215.00	—	—	—	—	—	—	—
Adjustable Extension Rod, 14' - 16' for 5547-F, 8847-F	ER-ADJ16-5547	-	\$215.00	—	—	—	—	—	—	—

NOTE: Fire rated devices over 8' may be provided less UL label based on the door application.
CAUTION: Other special door and frame conditions may require additional charges. Consult factory

ONE PIECE TOP ROD KITS									
Description	Specify		626	710	612	606	605 625	711	693
	Model number	Finish							
8 - for door heights up to 8' for 8827	OP-8-88	.[Finish]	\$144.00	\$205.00	\$222.00	\$222.00	\$444.00	—	\$444.00
8 - for door heights up to 8' for 9827, 9857, 9927, 9957	OP-8-99	.[Finish]	\$249.00	\$249.00	\$158.00	\$126.00	\$249.00	\$249.00	—
10' - for door heights up to 10' for 9827, 9857, 9927, 9957	OP-10-99	.[Finish]	\$275.00	\$275.00	\$174.00	\$152.00	\$269.00	\$269.00	—
12 - for door heights up to 12' for 9827, 9857, 9927, 9957	OP-12-99	.[Finish]	\$291.00	\$291.00	\$192.00	\$179.00	\$302.00	\$302.00	—

NOTE: Fire rated devices over 8' may be provided less UL label based on the door application.
CAUTION: Other special door and frame conditions may require additional charges. Consult factory

SECURITY SCREW PACKAGES

605	606	611	612	613	619	622	625	626	626AM	628	629
US3	US4	US9	US10	US10B	US15	US19	US26	US26D	US26DAM	US28	US32
630	630AM	643e	689	691	693	695	706	710	711	721	728
US32D	US32DAM	-	SP28	SP10	SPBLK	SP313	SP4	313	315	US3A	US4A

Security Screws are pin-in-socket type and require special hex wrenches

DEVICES	Wrench Model# Required	Price adjustment (all finishes)
22/22-F Rim	2	\$17.00
2227/2227-F	2	\$57.00
33A/35A Rim	2	\$29.00
33A/3527A	2	\$76.00
33/3547A/47A-F	2	\$42.00
88/88-F Rim/8875/75-F	2	\$48.00
8827	2	\$74.00
8827-F	2	\$109.00
8847-F	2	\$58.00
98/99/99-F/98-F Rim/98/9975/75-F	2	\$58.00
98/9927/27-F	2	\$69.00
98/9947/47-F and WDC	2	\$56.00

TRIMS AND CONTROLS	Wrench Model# Required	Price adjustment (all finishes)
230/880/990	2	\$15.00
230/990x330/350	2	\$48.00
386/360L-DTx330/350	2	\$23.00
371/373	2	\$32.00
374/376/377	2	\$15.00
696/697	2	\$14.00
696/697x330/350	2	\$29.00

MECHANICAL STRIKES	Wrench Model# Required	Price adjustment (all finishes)
1439/1606/248L-4/264/266/299/299F	2	\$15.00
1408	2	\$27.00
268	2	\$24.00
338	2	\$13.00
385A	2	\$11.00
499F	2	\$43.00
575/576	2	\$14.00

OTHER MECHANICAL PRODUCTS	Wrench Model# Required	Price adjustment (all finishes)
330/350 Pushbar	2	\$29.00
1654/4954 Mullion	2	\$41.00
5654/5754 Mullion	2	\$22.00
9954 Mullion	2, 4	\$95.00
154 Mullion Stabilizer	2	\$33.00
7500 Lock	2	\$14.00

Z2 SERIES
 33A/35A SERIES
 55 SERIES
 88 SERIES
 98/99 SERIES
 XP98/XP99 SERIES
 94/95 SERIES
 GUARD-X SERIES
 ACCESSORIES / PARTS
 ELECTRICAL / PARTS

SECURITY SCREW PACKAGES

605	606	611	612	613	619	622	625	626	626AM	628	629
US3	US4	US9	US10	US10B	US15	US19	US26	US26D	US26DAM	US28	US32
630	630AM	643e	689	691	693	695	706	710	711	721	728
US32D	US32DAM	-	SP28	SP10	SPBLK	SP313	SP4	313	315	US3A	US4A

Security Screws are pin-in-socket type and require special hex wrenches

ELECTRICAL PRODUCTS	Wrench Model# Required	Price adjustment (all finishes)
4263/4570/4582/4690 Monitor Strike	2	\$14.00
4570/4690 Monitor Strike	2	\$14.00
4670 Monitor Strike	2	\$14.00
6211-16/6222-26 Electric Strike	2	\$13.00
EPT	2	\$69.00

WRENCHES (ONE SET CHARGED PER ORDER UNLESS SPECIFIED OTHERWISE)	Model number	Specify	Price adjustment
1/8" Hex - #6 Screw	#1	010060-00	\$22.00
5/32" Hex - #8-1/4 Screw	#2	010059-00	\$22.00
7/32" Hex - 3/8 Screw	#3	010061-00	\$22.00
3/16" Hex - 5/16 Screw	#4	010062-00	\$22.00

SEX BOLTS

SEX BOLTS - MACHINE SCREWS ARE SUPPLIED WITH THE DEVICE	Specify	Price adjustment
Thread Size 10-24, Package of 2	425	\$28.00
Thread Size 12-24, Package of 2	625	\$28.00
Thread Size 1/4-20, Package of 2	325	\$28.00
Thread Size 12-24, Package of 2	525	\$28.00
Thread Size 10-24, Package of 2	825	\$28.00

REFERENCE NOTE: 625 and 825 sexbolts furnished standard for 1 3/4" thick door. Specify 2 1/4" if required.

SLM BLOCKING MOUNTING PACKAGES

SLM BLOCKING MOUNTING PACKAGES	Specify	Non-finished	605, 606, 613 630, 629
Description	Finish		
98/99 Rim	.[Finish]	\$24.00	—
9827/9927	.[Finish]	\$32.00	—
9875/9975/9847WDC/9947WDC/9850WDC/9950WDC	.[Finish]	\$14.00	—
88 Rim	.[Finish]	—	\$35.00
8827	.[Finish]	—	\$64.00
8875	.[Finish]	—	\$35.00
5547WDC	.[Finish]	—	\$43.00
RG-27	.[Finish]	\$32.00	—
RGO	.[Finish]	\$14.00	—
LGO	.[Finish]	\$14.00	—

REFERENCE NOTES: For use with devices on doors with special high density blocking material. Blocking material must be UL or Warnock Hersey approved.

PARTS AND ACCESSORIES

605	606	611	612	613	619	622	625	626	626AM	628	629
US3	US4	US9	US10	US10B	US15	US19	US26	US26D	US26DAM	US28	US32
630	630AM	643e	689	691	693	695	706	710	711	721	728
US32D	US32DAM	-	SP28	SP10	SPBLK	SP313	SP4	313	315	US3A	US4A

SCREW PACKS/SHIMS/MISCELLANEOUS

SHIMS

Description	Specify		Non-finished	689, 695 706, 691, 619
	Part number	Finish		
Shim 1409 Strike	959953	-	\$17.00	-
Shim 1606 Strike	961084	-	\$23.00	-
Shim 248L-4 Strike	969280	-	\$14.00	-
Shim 264/299F/499F Strike	945521	-	\$14.00	-
Shim 266 Strike	967333	.[Finish]	-	\$51.00
Shim 299 Strike	970321	-	\$14.00	-
Shim 268 Strike Auxilliary Bolt	967269	-	\$14.00	-
909 Strike Shim Pkg/4	090108	-	\$70.00	-
Mullion Stabilizer Shim	961530	-	\$13.00	-
99 Hinge Stile Shim	971010	.[Finish]	-	\$51.00

SCREW PACKS

Description	Specify		Non-finished	630	612	605, 606, 613	689, 695 706, 691, 619
	Part number	Finish					
Screw Package 268/472/473	900252	-	\$14.00	-	-	-	-
Screw Package 1408	900253	-	\$14.00	-	-	-	-
Screw Package 1409/1410/1439	900254	-	\$17.00	-	-	-	-
Screw Package 248L-4/264/266/1606	900263	-	\$14.00	\$14.00	-	\$14.00	-
Screw Package 4263/4582	900281	.[Finish]	-	\$15.00	-	\$15.00	-
Screw Package 4268	900284	.[Finish]	-	\$14.00	\$22.00	\$14.00	-
Screw Package 338	900285	-	\$14.00	-	-	-	-
Screw Package 499-F	900289	-	\$17.00	-	-	-	-
Screw Package 575/575-2/576/4690	900532	.[Finish]	-	\$14.00	\$14.00	\$14.00	-
Screw Package 889 Cover Plate	900820	.[Finish]	-	\$17.00	\$17.00	\$17.00	-
Screw Package 99GBK-R x 499F 1 3/4" Dr	900847	.[Finish]	-	\$23.00	\$23.00	\$23.00	-
Screw Package 99GBK-R x 499F 2 1/4" Dr	900848	.[Finish]	-	\$23.00	\$23.00	\$23.00	-
Screw Package 99GBK-R/M/V	900849	-	\$22.00	-	-	-	-
Screw Package RG27	900888	-	\$15.00	-	-	-	-

MISCELLANEOUS

Description	Specify		Non-finished	630	612	605, 606, 613, 629	689, 695 706, 691, 622
	Part number	Finish					
DL Lubricant 1 oz.	091091	-	\$13.00	-	-	-	-
Monitor Strike Spacer Plate - 4263/4268	966671	-	\$17.00	-	-	-	-
Strike Hook 499-F	661481	.[Finish]	-	\$133.00	\$133.00	\$133.00	-
Strike Plate 299	970323	-	\$14.00	-	-	-	-
Strike Pop Rivet 1409/1439	963074	-	\$14.00	-	-	-	-

Z2 SERIES
 33A/35A SERIES
 55 SERIES
 88 SERIES
 98/99 SERIES
 XP98/XP99 SERIES
 94/95 SERIES
 GUARD-X SERIES
 ACCESSORIES / PARTS
 ELECTRICAL / PARTS

PARTS AND ACCESSORIES

605	606	611	612	613	619	622	625	626	626AM	628	629
US3	US4	US9	US10	US10B	US15	US19	US26	US26D	US26DAM	US28	US32
630	630AM	643e	689	691	693	695	706	710	711	721	728
US32D	US32DAM	-	SP28	SP10	SPBLK	SP313	SP4	313	315	US3A	US4A

MISCELLANEOUS

Description	Specify		Non-finished	630	612	605, 606, 613, 629	689, 695, 706, 691, 622
	Part number	Finish					
1409 Adjusting Block	959952	-	\$17.00	-	-	-	-
1409/1410 Wear Strip	960012	-	\$27.00	-	-	-	-
Latch Guard Mounting Bracket	970472	-	\$17.00	-	-	-	-
Security Screw Hex Key 5/32"	010059	-	\$22.00	-	-	-	-
Security Screw Hex Key 1/8"	010060	-	\$22.00	-	-	-	-
Security Screw Hex Key 7/32"	010061	-	\$22.00	-	-	-	-
Security Screw Hex Key 3/16"	010062	-	\$22.00	-	-	-	-
299F Strike Adapter	050996	.[Finish]	-	-	-	-	\$174.00
WDC Strike Filler Plate kit	47244841	-	\$14.00	-	-	-	-

MAINTENANCE KIT AND REPLACEMENT PACKAGES

MAINTENANCE KIT AND REPLACEMENT PACKAGES

Description	Part number	List price
98/99 Maintenance Kit	050046	\$1,258.00
Control Link Pin Pkg/10	090031	\$17.00
33/35/98/99 Touch Bar Guide Pkg/10	090049	\$15.00
NL Drive Screw Pkg/10	090074	\$22.00
98/9927/27-F Auxiliary Bolt Spring Pkg/ 10	090076	\$14.00
Bolt Return Spring Pkg/10	090065	\$14.00
#10 External Tooth Lock Washer Pkg/10	PKGSRV.1007	\$15.00
Top Latch Compression Spring Pkg/10	090056	\$14.00
Truarc Retaining Ring T5304-18 Pkg/10	090107	\$14.00
Shear Pin - 360/992/994/996 Pkg/50	PKGSRV.1010	\$68.00
992L Lift Spring Pkg/20	PKGSRV.1011	\$25.00
1/4-20 Hex Stud - 991/992 Pkg/10	PKGSRV.1012	\$32.00
Truarc Retaining Ring 5160-42 Pkg/10	PKGSRV.1013	\$22.00
10-32 X 1/4" UFPHMS w/Nylock Pkg/6	090059	\$14.00
10-24 x 3/4" PPHMS Pkg/10	PKGSRV.1015	\$15.00
10-24 x 1" PPHMS Pkg/20	PKGSRV.1016	\$17.00
8-32 X 1/4" UFPHMS Pkg/20	PKGSRV.1018	\$14.00
LBR Latch Mtg Screw Pkg/10	PKGSRV.1019	\$16.00
1/4-20 X 3/4" UFPHMS Pkg/10	PKGSRV.1020	\$23.00
10-24 X 1 3/8" PPHMS Pkg/20	PKGSRV.1022	\$23.00
10-24 X 3/4" FPHMS Pkg/10	PKGSRV.1023	\$15.00
12-24 1/2" Hex Wshr Hd Tapping Screw Pkg/10	090073	\$12.00

PARTS AND ACCESSORIES

605	606	611	612	613	619	622	625	626	626AM	628	629
US3	US4	US9	US10	US10B	US15	US19	US26	US26D	US26DAM	US28	US32
630	630AM	643e	689	691	693	695	706	710	711	721	728
US32D	US32DAM	-	SP28	SP10	SPBLK	SP313	SP4	313	315	US3A	US4A

SERVICE REPLACEMENT PARTS

SERVICE REPLACEMENT									
Description	Specify		Non-finished	613 626	612	606	605 625	629, 693, 695	622, 630
	Part number	Finish							
7500-880TP Retrofit Kit	050122	.[Finish]	-	\$74.00	-	\$74.00	\$74.00	-	-
End Cap Mtg. Brkt. Screw (Pkg of 30)	090060	-	\$57.00	-	-	-	-	-	-
Old Style Hex Dogging Retrofit Kit	050709	-	\$74.00	-	-	-	-	-	-
Old Style 227 Dog Key 5/32" (Pkg of 10)	090084	-	\$76.00	-	-	-	-	-	-
34/58 Thumb Latch Lift Spring (Pkg of 5)	091030	-	\$74.00	-	-	-	-	-	-
34/58 Dog Lock Spring (Pkg of 10)	091031	-	\$133.00	-	-	-	-	-	-
34/58 Auxiliary Bolt Spring (Pkg of 10)	091032	-	\$219.00	-	-	-	-	-	-
66 Dog Screw (Pkg of 10)	091061	-	\$155.00	-	-	-	-	-	-
222 Dog Key 7/32" (Pkg of 10)	091080	-	\$104.00	-	-	-	-	-	-
Wedgetite Screw - Fine Thread (Pkg of 10)	091082	-	\$70.00	-	-	-	-	-	-
370 Series 6-32 x 1/4 UFPHMS	963150	-	\$14.00	-	-	-	-	-	-
370 Series 1/4-20 x 1 Set Screw	963584	-	\$14.00	-	-	-	-	-	-
33/3527 Bottom Rod Roll Pin	963585	-	\$14.00	-	-	-	-	-	-
SS333NL Backplate Screw 8-32 x 3/8" PPHMS	963712	-	\$14.00	-	-	-	-	-	-
10-24 x 1/2" UFPHMS Epoxy Lock	963873	-	\$14.00	-	-	-	-	-	-
370 Series 6-32 x 7/16" PPHMS	963902	-	\$14.00	-	-	-	-	-	-
333/337 1/4-20 x 2 Socket Set Screw	963905	-	\$14.00	-	-	-	-	-	-
370 Series #10 Flat Washer	964375	-	\$14.00	-	-	-	-	-	-
334/333/337/3308 Sex Bolt Extension	971614	-	\$15.00	-	-	-	-	-	-
992L Replacement Cam Kit w/Slider	050155	-	\$132.00	-	-	-	-	-	-
992L Replacement Cam Kit Less Slider	050157	-	\$54.00	-	-	-	-	-	-
SD WDC FINGER KIT	47244842	-	\$99.00	-	-	-	-	-	-

Z2 SERIES
 33A/35A SERIES
 55 SERIES
 88 SERIES
 98/99 SERIES
 XP98/XP99 SERIES
 94/95 SERIES
 GUARD-X SERIES
 ACCESSORIES / PARTS
 ELECTRICAL / PARTS

PARTS AND ACCESSORIES

605	606	611	612	613	619	622	625	626	626AM	628	629
US3	US4	US9	US10	US10B	US15	US19	US26	US26D	US26DAM	US28	US32
630	630AM	643e	689	691	693	695	706	710	711	721	728
US32D	US32DAM	-	SP28	SPI0	SPBLK	SP313	SP4	313	315	US3A	US4A

SERVICE REPLACEMENT

Description	Specify		Non-finished	613 626	612	606	605 625	629, 693, 695	622, 630	
	Part number	Finish								
NOTE ORIGINAL SHIP DATE ON PARTS LISTED BELOW										
For EL Devices shipped before January 1987										
EL Solenoid Replacement Kit	050218	-	\$755.00	-	-	-	-	-	-	-
For Trims shipped before October 1989										
Orbit Knob Assy - 606K/880K Trim	108490	.[Finish]	-	\$224.00	-	\$224.00	\$224.00	-	-	-
Orbit Knob Assy - 606K-DT/880K-DT Trim	108493	.[Finish]	-	\$224.00	-	\$224.00	\$224.00	-	-	-
880 Knob Booster Spring Assembly	033024	-	\$54.00	-	-	-	-	-	-	-
For Devices shipped before July 1997										
#22 Hitch Pin - Hex/CD Dogging old style	963909	-	\$14.00	-	-	-	-	-	-	-
Dogging Shaft - Hex Dogging Old Style	968112	-	\$17.00	-	-	-	-	-	-	-
CD Actuator Arm - Cylinder Dogg Old Style	968116	-	\$15.00	-	-	-	-	-	-	-
For Devices shipped before August 1997										
7500-373L Retrofit Kit	050124	-	\$23.00	-	-	-	-	-	-	-
For Devices shipped before October 1998										
22/98/9927/-F Btm Latch/Brkt Repl. Kit	050090	.[Finish]	-	-	\$155.00	\$155.00	\$155.00	\$155.00	\$155.00	\$155.00
22/98/9927/-F Top Latch/Brkt Repl. Kit	050091	.[Finish]	-	-	\$155.00	\$155.00	\$155.00	\$155.00	\$155.00	\$155.00
22/98/9927/27-F Latch Mtg. Screws 1 3/4" Dr	900564	-	\$14.00	-	-	-	-	-	-	-
22/98/9927/27-F Latch Mtg. Screws 2 1/4" Dr	900569	-	\$14.00	-	-	-	-	-	-	-
For Devices shipped before January 2002										
Mechanism End Cap Screw Package	900901	.[Finish]	-	\$14.00	\$17.00	\$14.00	-	-	-	\$14.00
RX 330/350 Old Style End Cap Mtg. Bracket for Lock Stile	050397	-	\$14.00	-	-	-	-	-	-	-
For Devices shipped before April 2003										
47 Btm Latch Spirol Pin (Pkg of 10)	090062	-	\$17.00	-	-	-	-	-	-	-
For Controls shipped before January 2008										
376WDC Rod member Kit 1 3/4"	109113	-	\$142.00	-	-	-	-	-	-	-
376WDC Rod Member Kit 2" Door	900583	.[Finish]	-	\$152.00	\$152.00	\$152.00	\$152.00	\$152.00	\$152.00	\$152.00
376WDC Rod Member Kit 2 1/4" Door	109118	-	\$200.00	-	-	-	-	-	-	-

- 22 SERIES
- 33A/35A SERIES
- 55 SERIES
- 88 SERIES
- 98/99 SERIES
- XP98/XP99 SERIES
- 94/95 SERIES
- GUARD-X SERIES
- ACCESSORIES / PARTS
- ELECTRICAL / PARTS

ELECTRICAL PRODUCTS AND PARTS

ALARM KITS

605	606	611	612	613	619	622	625	626	626AM	628	629
US3	US4	US9	US10	US10B	US15	US19	US26	US26D	US26DAM	US28	US32
630	630AM	643e	689	691	693	695	706	710	711	721	728
US32D	US32DAM	-	SP28	SP10	SPBLK	SP313	SP4	313	315	US3A	US4A

ALARM KITS

Description	Specify		619	689, 695	606, 628, 612, 710	630	605, 625, 711
	Model number	Finish					
Alarm Kit for 22 Series devices	22 ALK	.[Finish]	—	\$586.00	—	—	—
Alarm Kit for 33A Series devices	33A-ALK	.[Finish]	—	—	\$660.00	—	\$660.00
Alarm Kit for 35A Series devices	35A-ALK	.[Finish]	\$660.00	—	\$660.00	—	\$660.00
Alarm Kit for 98 Series devices	98 ALK	.[Finish]	\$660.00	—	\$660.00	\$660.00	\$660.00
Alarm Kit for 99 Series devices	99 ALK	.[Finish]	—	—	\$660.00	—	\$660.00

REFERENCE NOTES:

RX is standard, LX is optional at no charge.

When ordering alarm kits separate from devices, the 3' device kit is furnished standard. Specify 4' if required, no additional charge.

The "EI" External Inhibit feature is standard on the ALK at no additional charge.

OPTIONS

CONNECTORS	Specify	Price adjustment
Cross-category solution using interconnect components for electrified options. Available with ALK at no additional charge.	CON	\$0.00

SWITCHES - Above prices include switch kit - "RX" is standard, "LX" is optional at no charge.	Specify	Price adjustment
Less Switch	Less Switch	-\$266.00

PARTS AND ACCESSORIES

Description	Specify		Non-finished	689, 695	606, 626, 695	612, 619, 625, 622, 605
	Part number	Finish				
ALK PCB Assembly	101030	-	\$506.00	—	—	—
ALK Cylinder Collar - 22	967704	.[Finish]	—	\$25.00	—	—
ALK Cylinder Collar - 33A/35A/98/99	050525	.[Finish]	—	\$48.00	\$48.00	\$58.00
ALK Sign	SIGN-1	-	\$26.00	—	—	—
ALK Arming Label	969349	-	\$14.00	—	—	—
ALK Disarming Label	969350	-	\$14.00	—	—	—
ALK Retainer Nut	969354	-	\$26.00	—	—	—
ALK Cylinder Spacer	970594	-	\$17.00	—	—	—
ALK Switch Actuator	971556	-	\$23.00	—	—	—
ALK Cylinder Bracket	971557	-	\$15.00	—	—	—
ALK Battery	990637	-	\$25.00	—	—	—
ALK CON Adapter Harness	106182	-	\$14.00	—	—	—
Cover Plate Anti-Rattle Spring Pkg/10	090036	-	\$14.00	—	—	—

MORTISE LOCKS

605	606	611	612	613	619	622	625	626	626AM	628	629
US3	US4	US9	US10	US10B	US15	US19	US26	US26D	US26DAM	US28	US32
630	630AM	643e	689	691	693	695	706	710	711	721	728
US32D	US32DAM	-	SP28	SP10	SPBLK	SP313	SP4	313	315	US3A	US4A

MORTISE LOCKS

Description	Specify		630	605, 606, 622, 612, 613, 629
	Model number	Finish		
Standard Mortise Lock	7500	.[Finish]	\$708.00	\$730.00
Double Cylinder Mortise Lock	7500-2	.[Finish]	\$924.00	\$946.00
INPACT Device Mortise Lock	7500-IN	.[Finish]	\$880.00	\$903.00
Electric Unlocking Mortise Lock	E7500	.[Finish]	\$1,369.00	\$1,391.00
Signal Switch Mortise Lock	SS7500	.[Finish]	\$976.00	\$998.00
94/9575 Signal Switch Mortise Lock	SS7500-IN	.[Finish]	\$1,136.00	\$1,159.00

OPTIONS

E7500 - Furnished standard 24VDC if not specified. 12VDC available at no additional charge.	Specify (Prefix)	Price adjustment
<ul style="list-style-type: none"> AC requires SO12 or SO24 Rectifier Kit Available with TP, K, or L functions only SO rectifier kit intended for fail secure / momentary use only. Contact product support for assistance. 	24VAC or 12VAC	\$45.00
Fail Mode: FAIL SECURE (FSE) or FAIL SAFE (FS)	FSE or FS	\$0.00

CONNECTORS

Cross-category solution using interconnect components for electrified options. Available for E7500 and SS7500 at no additional charge.	Specify	Price adjustment
Note: See catalog section on SS7500 or E7500 for required accessory equipment.	CON	\$0.00

SWITCHES

REQUEST TO EXIT SWITCHES	Specify	Price each (non-finished)
RX Switch Kit	050251-00	\$266.00
WP-RX-AUX Waterproof Switch Kit	051881-00	\$384.00
RX-LC Switch Kit	050281-00	\$309.00
RX-2 Switch Kit	050270-00	\$331.00
RX-Aux Switch Kit	050271-00	\$277.00

LATCHBOLT MONITORING SWITCHES	Specify	Price each (non-finished)
LX Switch Kit 3' Device	050254-00	\$266.00
LX Switch Kit 4' Device	050255-00	\$266.00
LX-LC Switch Kit 3' Device	050283-00	\$309.00
LX-LC Switch Kit 4' Device	050285-00	\$309.00
EL-LX Switch Kit	050247-00	\$266.00
EL-LX-LC Switch Kit	050287-00	\$309.00

SWITCHES

605	606	611	612	613	619	622	625	626	626AM	628	629
US3	US4	US9	US10	US10B	US15	US19	US26	US26D	US26DAM	US28	US32
630	630AM	643e	689	691	693	695	706	710	711	721	728
US32D	US32DAM	-	SP28	SP10	SPBLK	SP313	SP4	313	315	US3A	US4A

REQUEST TO EXIT / LATCHBOLT MONITORING COMBINATION SWITCHES	Specify	Price each (non-finished)
LX-RX Switch Kit 3' Device	050256-00	\$402.00
LX-RX Switch Kit 4' Device	050257-00	\$402.00
LX-RX-LC Switch Kit 3' Device ^a	050289-00	\$483.00
LX-RX-LC Switch Kit 4' Device	050291-00	\$483.00
EL-LX-RX Switch Kit	050259-00	\$402.00
EL-LX-RX-LC Switch Kit	050293-00	\$483.00
LX 94/95 Switch Kit (After 4/2005)	050226-00	\$266.00

Consult technical support for details.

DELAYED EXIT SYSTEM

RELEASE DELAY	Specify	Price each
Logic Controller 15 Second Delay (furnished standard) ¹	DE5300	\$1,040.00
0 Second Delay [⌘]	0 Delay	\$142.00
30 Second Delay [⌘]	30 Delay	\$142.00
15 second delay with BOCA Modification [⌘]	BOCA-15 Delay	\$142.00
30 second delay with BOCA Modification [⌘]	BOCA-30 Delay	\$142.00

Note: Designed to meet NFPA 101 "Special Locking Arrangement" applications. A complete system requires several components not included with controller. Consult catalog for details.

¹ Over 15 second delay requires a letter of approval from the authority having local jurisdiction over the premises prior to the installation of the device. Allegion cannot grant such approval nor does it warrant local jurisdiction compliance.

[⌘] Consult factory for lead time.

INTERFACE BOXES/RELAYS

INTERFACE BOXES/RELAYS	Specify	Price each
Enclosure with terminal strip. Optional relays are available for factory or field installation.	JB7	\$718.00
FACTORY INSTALLED	Specify	Price each per interface box
24VDC SPDT	R1	\$312.00
24VDC DPDT	R2	\$312.00
24VDC DPDT Delay on Make Time Delay	R3	\$513.00
24VDC DPDT Delay on Break Time Delay	R4	\$513.00
PARTS (FIELD INSTALLABLE)	Specify	Price each
24VDC SPDT	Relay Kit R5	\$312.00
24VDC DPDT	Relay Kit R6	\$312.00
24VDC DPDT - Delay on Make Time Delay	Relay Kit R7	\$513.00
24VDC DPDT - Delay on Break Time Delay	Relay Kit R8	\$513.00

ALLEGION CONNECT

605	606	611	612	613	619	622	625	626	626AM	628	629
US3	US4	US9	US10	US10B	US15	US19	US26	US26D	US26DAM	US28	US32
630	630AM	643e	689	691	693	695	706	710	711	721	728
US32D	US32DAM	-	SP28	SP10	SPBLK	SP313	SP4	313	315	US3A	US4A

ALLEGION CONNECT HARNESSSES	Specify	Price each
MOLEX CONNECTORS ON BOTH ENDS (FOR USE WITH HOLLOW METAL DOORS)		
6" Wire Harness (internal p/n 106190-00)	CON-6	\$12.00
12" Wire Harness (internal p/n 106191-00)	CON-12	\$16.00
26" Wire Harness (internal p/n 106192-00)	CON-26	\$18.00
32" Wire Harness (internal p/n 106193-00)	CON-32	\$19.00
38" Wire Harness (internal p/n 106194-00)	CON-38	\$21.00
44" Wire Harness (internal p/n 106195-00)	CON-44	\$20.00
50" Wire Harness (internal p/n 106196-00)	CON-50	\$21.00
192" Wire Harness (internal p/n 106197-00)	CON-192	\$48.00
MOLEX CONNECTOR ON ONE END, CRIMPED PINS ON OTHER W/ ATTACHABLE MOLEX CONNECTOR (FOR USE WITH WOOD DOORS)		
6" Wire Harness (internal p/n 106201-00)	CON-6P	\$15.00
12" Wire Harness (internal p/n 106202-00)	CON-12P	\$19.00
26" Wire Harness (internal p/n 106203-00)	CON-26P	\$21.00
32" Wire Harness (internal p/n 106204-00)	CON-32P	\$22.00
38" Wire Harness (internal p/n 106205-00)	CON-38P	\$22.00
44" Wire Harness (internal p/n 106206-00)	CON-44P	\$23.00
50" Wire Harness (internal p/n 106207-00)	CON-50P	\$24.00
192" Wire Harness (internal p/n 106208-00)	CON-192P	\$50.00
MOLEX CONNECTOR ON ONE END, STRIPPED LEADS ON OTHER (FOR CONNECTION TO POWER SUPPLY)		
6" extension to power supply (internal p/n 106210-00)	CON-6W	\$15.00
SERVICE KIT		
Connector Service Kit (internal p/n 050823-00-00) contains: <ul style="list-style-type: none"> 100 each male & female terminals 10 each 4-pin and 8-pin male connectors 10 each 4-pin and 8-pin female connectors 1 extraction tool 	CON-KIT	\$120.00

CON Adapter Harnesses for electrified hardware are located in the parts section with their corresponding products.

ELECTRIC POWER TRANSFERS

ELECTRIC POWER TRANSFERS				
Description	Specify		689	695
	Model number	Finish		
Two 18 gauge wires	EPT 2	.[Finish]	\$504.00	\$504.00
Ten 24 gauge wires	EPT 10	.[Finish]	\$535.00	\$535.00
"Buy America Act" compliant EPT option will be labeled as "Assembled in the U.S.A. with U.S. and foreign materials"	BAA	.[Finish]	\$0.00	\$0.00
Connector (CON) is a cross category solution using common interconnect components for electrified options. Available for EPT10. Specify CON.	CON	.[Finish]	\$11.00	\$11.00

22 SERIES
 33A/35A SERIES
 55 SERIES
 88 SERIES
 98/99 SERIES
 XP98/XP99 SERIES
 94/95 SERIES
 GUARD-X SERIES
 ACCESSORIES / PARTS
 ELECTRICAL / PARTS

POWER SUPPLIES

605	606	611	612	613	619	622	625	626	626AM	628	629
US3	US4	US9	US10	US10B	US15	US19	US26	US26D	US26DAM	US28	US32
630	630AM	643e	689	691	693	695	706	710	711	721	728
US32D	US32DAM	-	SP28	SP10	SPBLK	SP313	SP4	313	315	US3A	US4A

1. SELECT POWER SUPPLY

DESCRIPTION	Specify	Price each
Base Power Supply (2A @ 12/24 VDC- field selectable) PS902 is able to accept a total of one optional distribution board, plus one fire alarm relay along with one battery backup board and up to two 7A/hr batteries	PS902	\$270.00
Base Power Supply (4A @ 12/24 VDC- field selectable) PS904 is able to accept a total of two optional distribution boards, plus one battery backup board and up to two 7A/hr batteries	PS904	\$511.00
Base Power Supply (6A @ 12/24 VDC- field selectable) PS906 is able to accept a total three optional distribution boards or two optional boards with battery backup board and two 7A/hr batteries	PS906	\$790.00
Base Power Supply (4A w/ 16A inrush @ 12/24 VDC- field selectable) PS914 is able to accept a total of two optional boards, plus one battery backup board and two 7A/hr batteries	PS914	\$774.00
The PS914RFK allows the retrofit of the PS914 into an existing PS873 cabinet.	PS914RFK	\$906.00
"Buy America Act" compliant power supply option will be labeled as "Assembled in the U.S.A. with U.S. and foreign materials"	BAA	\$42.00

NOTE: When specifying power supply with "EL" or "QEL" Electric Latch Retraction devices, the 2RS is furnished when board option is not specified.

2. SELECT OPTIONAL DISTRIBUTION BOARD WITH OR WITHOUT FA (FIRE ALARM RELAY)

DESCRIPTION	Model	Specify	Price each
Independently controlled relays	900-4R	44489912-00	\$182.00
Independently controlled relays with FA	900-4R-FA	4448912-00 & 44487247-00	\$249.00
2 Relay board output	900-2RS	44489896-00	\$185.00
2 Relay board output with FA	900-2RS-FA	44489896-00 & 44487247-00	\$252.00
4 Relay board integrated logic for controlling security interlocks, auto operators and time delays	900-4RL	44489920-00	\$500.00
4 Relay board integrated logic for controlling security interlocks, auto operators and time delays with FA	900-4RL-FA	44489920-00 & 44487247-00	\$567.00
8 fuse protected outputs	900-8F	44489946-00	\$67.00
8 fuse protected outputs with FA	900-8F-FA	44489946-00 & 44487247-00	\$134.00
8 PTC protected outputs	900-8P	44489938-00	\$67.00
8 PTC protected outputs with FA	900-8P-FA	44489938-00 & 44487247-00	\$134.00
Battery Backup Kit (includes two 7A/hr batteries)	900-BBK	44489961-00	\$261.00
Battery Backup board only (sold separately)	900-BB	44489953-00	\$131.00
Batteries only - (two 7A/hr batteries, sold separately)	900-BAT	44487155-00	\$131.00

NOTE: For field installation, use model number. Example: 900-2RS.

Standard Features

- UL294 Listed for Access Control
 - Class 2 rated power limited output*
 - Universal 120-240 VAC Input
 - Regulated and filtered DC outputs
 - AC input, battery and DC output LED indicators
 - Plug and play connectors for optional distribution boards
 - AC input status indication on outside cover
 - AC monitoring
 - 14" H x 12" W x 4" D enclosure
- * PS906 is Class 2 when used with 900-8P option board

POWER SUPPLIES

605	606	611	612	613	619	622	625	626	626AM	628	629
US3	US4	US9	US10	US10B	US15	US19	US26	US26D	US26DAM	US28	US32
630	630AM	643e	689	691	693	695	706	710	711	721	728
US32D	US32DAM	-	SP28	SP10	SPBLK	SP313	SP4	313	315	US3A	US4A

3. SELECT OTHER POWER SUPPLY OPTIONS

DESCRIPTION	Model	Specify	Price each
Fire Alarm Relay (EIR) module is a plug-in relay to provide an interface with fire or other emergency override systems <ul style="list-style-type: none"> PS902: may be installed directly on power supply or may be used with optional distribution boards PS904, PS906, PS914: must be used with optional distribution boards. If an optional board is not listed the 900-8F-FA will be provided. 	900-FA	44487247-00	\$67.00
Key Lock Cover (not available with BAA)	900-KL	44486850-00	\$42.00

Note: PS902, PS904, PS 906 and PS914 power supplies require connection to AC line voltage. Installation and all electrical connections (high and low voltage) should be performed by a qualified electrical contractor.

Standard Features

- UL294 Listed for Access Control
- Class 2 rated power limited output*
- Universal 120-240 VAC Input
- Regulated and filtered DC outputs
- AC input, battery and DC output LED indicators
- Plug and play connectors for optional distribution boards
- AC input status indication on outside cover
- AC monitoring
- 14" H x 12" W x 4" D enclosure
- * PS906 is Class 2 when used with 900-8P option board

ELECTRIC STRIKES

605	606	611	612	613	619	622	625	626	626AM	628	629
US3	US4	US9	US10	US10B	US15	US19	US26	US26D	US26DAM	US28	US32
630	630AM	643e	689	691	693	695	706	710	711	721	728
US32D	US32DAM	-	SP28	SP10	SPBLK	SP313	SP4	313	315	US3A	US4A

NOMENCLATURE – HOW TO ORDER

Model	Power failure mode	Dual switch	Voltage	Rectifier kit	Shim	Finish	Buzzer	Allegion Connect
1	2	3	4	5	6	7	8	9

Specify for:

1 Model

2 Power failure mode

- 6100 For rim exit devices
- 6200 For mortise or cylindrical locks

3 Dual switch (optional)

- 6100 For rim devices
- 6200 For mortise or cylindrical locks

4 Voltage

- 6100 For rim exit devices
- 6200 For mortise or cylindrical locks

5 Rectifier kit (optional)

- 4200 Fire cylindrical and deadlatch locks
- 5100 Fire cylindrical and deadlatch locks
- 6100 For rim exit devices
- 6200 For mortise or cylindrical locks
- 6300 Surface mount strike for rim exit devices
- 6400 Modular strike for mortise/cylindrical locks

6 Shim (optional)

- 6100 For rim devices
- 6300 Surface mount strike for rim exit devices

7 Finish

- 5100 Fire cylindrical and deadlatch locks
- 6100 For rim exit devices
- 6200 For mortise or cylindrical locks

8 Buzzer (optional)

- 4200 Fire cylindrical and deadlatch locks
- 5100 Fire cylindrical and deadlatch locks
- 6100 For rim exit devices
- 6200 For mortise or cylindrical locks
- 6300 Surface mount strike for rim exit devices
- 6400 Modular strike for mortise/cylindrical locks

9 Allegion Connect

- 6100 For rim exit devices
- 6200 For mortise or cylindrical locks

ELECTRIC STRIKES

605	606	611	612	613	619	622	625	626	626AM	628	629
US3	US4	US9	US10	US10B	US15	US19	US26	US26D	US26DAM	US28	US32
630	630AM	643e	689	691	693	695	706	710	711	721	728
US32D	US32DAM	-	SP28	SP10	SPBLK	SP313	SP4	313	315	US3A	US4A

4200 SERIES

4200 SERIES ELECTRIC STRIKES FOR CYLINDRICAL AND DEADLATCH LOCKS

Description	Throw	Fire Rated	Hollow Metal	Wood	Aluminum	Single	Mullion Pair	Model	Finish	630
4211 - Shallow 1-3/8" backbox depth	1/2"-3/4"		■		■	■		4211	[Finish]	\$207
4212 - Includes latchbolt monitor. Shallow backbox.	1/2"-5/8"		■		■	■		4212	[Finish]	\$249

OPTIONS

OPTIONS		Specify	Price each
SO12 Rectifier Kit	Converts 12 VAC to 12 VDC	12 VAC	\$45.00
SO24 Rectifier Kit	Converts 24 VAC to 24 VDC	24 VAC	\$45.00
Entry Buzzer	Use in fail-secure applications	EB	\$44.00
Faceplate, Round Corner	Additional faceplate option, square corner is standard in the box, both in BHMA 630/US32D satin stainless steel finish	090110	\$21.00

Refer to the Electric Strike Parts section for a complete list of available parts.

NOTE: SO rectifier kit intended for fail secure / momentary use only. Contact product support for assistance.

Features

- Field selectable fail-safe/fail-secure without disassembly
- Dual voltage: 12 VDC at 200 mA / 24 VDC at 100 mA
- Compatible with all Schlage and Falcon cylindrical locks as well as cylindrical and deadlatch locks of many other manufacturers
- Meets ANSI/BHMA 156.31 Grade 1 endurance & dynamic strength
- Meets ANSI/BHMA 156.31 Grade 2 static strength

5100 SERIES

5100 SERIES ELECTRIC STRIKE FOR CYLINDRICAL AND DEADLATCH LOCKS

Description	Throw	Fire rated	Hollow metal	Wood	Aluminum	Single	Mullion pair	Model	Finish	689	622	695
5100 - 3 faceplates included with hardware for an all-in-one boxed solution	1/2"-5/8"		■	■	■	■		5100-3FP	[Finish]	\$268	\$268	\$268

OPTIONS

OPTIONS		Specify	Price each
SO12 Rectifier Kit	Converts 12 VAC to 12 VDC	12 VAC	\$45.00
SO24 Rectifier Kit	Converts 24 VAC to 24 VDC	24 VAC	\$45.00
Entry Buzzer	Use in fail-secure applications	EB	\$44.00

Refer to the Electric Strike Parts section for a complete list of available parts.

NOTE: SO rectifier kit intended for fail secure / momentary use only. Contact product support for assistance.

Features

- Adjustable keeper improves fit on tight door preps
- Field selectable fail-safe/fail-secure
- Dual voltage: 12 VDC at 380 mA / 24 VDC at 190 mA
- Compatible with Schlage and Falcon cylindrical and deadlatch locks including those of many other manufacturers
- UL 1034 burglary-resistant

ELECTRIC STRIKES

605	606	611	612	613	619	622	625	626	626AM	628	629
US3	US4	US9	US10	US10B	US15	US19	US26	US26D	US26DAM	US28	US32
630	630AM	643e	689	691	693	695	706	710	711	721	728
US32D	US32DAM	-	SP28	SP10	SPBLK	SP313	SP4	313	315	US3A	US4A

6100 SERIES

6100 SERIES ELECTRIC STRIKES FOR RIM EXIT DEVICES

Description	Throw	Fire rated	Hollow metal	Wood	Aluminum	Single	Mullion pair	Model	Finish	605	606	612	613	629	630
6111 - Can use with vertical rod exit devices	3/4"	■	■	■	■	■	■	6111	.[Finish]	\$1,008	\$945	\$978	\$978	\$953	\$928
6111-55R - Designed for use with 55 rim device only	3/4"	■	■	■	■	■	■	6111-55R	.[Finish]	\$1,008	\$945	\$978	\$978	\$953	\$928
6112 - Designed to replace FA 310-5 with minor frame modification	3/4"	■	■	■	■	■	■	6112	.[Finish]	\$948	\$885	\$918	\$918	\$893	\$868
6113 - Retrofits VD 3011, 3021	3/4"	■	■	■	■	■	■	6113	.[Finish]	\$1,008	\$945	\$978	\$978	\$953	\$928
6114 - Surface applied for use with rim nightlatch devices	3/4"	■	■	■	■	■	■	6114	.[Finish]	\$978	\$915	\$948	\$948	\$923	\$898
6121 - For rim exit devices on double doors without mullion ¹	3/4"	■	■	■	■	■	1	6121	.[Finish]	\$1,373	\$1,310	\$1,343	\$1,343	\$1,318	\$1,293

For options, please see list under 6200 Series section. Also, refer to the Electric Strike Parts section for a complete list of available parts.

Features

- Furnished standard in fail secure configuration unless specified fail safe (see options)
- 24 VDC supplied standard if not specified otherwise (see options)
- Compatible with Von Duprin and Falcon rim exit devices and those of many other manufacturers
- UL10C fire rated (fail secure only)
- UL1034 burglary-resistant

6200 SERIES

6200 SERIES ELECTRIC STRIKES FOR MORTISE OR CYLINDRICAL LOCKS

Description	Throw	Fire rated	Hollow metal	Wood	Aluminum	Single	Mullion pair	Model	Finish	605	606	612	613	629	630
6210 - Mortise only. Includes strike pocket inserts for deadlocking triggers	3/4"	■	■	■	■	■	■	6210	.[Finish]	\$926	\$863	\$896	\$896	\$871	\$846
6211 - Retrofits VD 3140 or FA 712	3/4"	■	■	■	■	■	■	6211	.[Finish]	\$877	\$814	\$847	\$847	\$822	\$797
6211AL - Retrofits FA 722	3/4"	■	■	■	■	■	■	6211AL	.[Finish]	\$908	\$845	\$878	\$878	\$853	\$828
6211WF - Retrofits FA 732 with minor frame modification	3/4"	■	■	■	■	■	■	6211WF	.[Finish]	\$886	\$823	\$856	\$856	\$831	\$806
6212 - Fits modified ANSI 115.2 cutout. Retrofits VD 3146.	3/4"	■	■	■	■	■	■	6212	.[Finish]	\$1,023	\$960	\$993	\$993	\$968	\$943
6212WF	3/4"	■	■	■	■	■	■	6212WF	.[Finish]	\$1,023	\$960	\$993	\$993	\$968	\$943
6213 - Retrofits VD 3041, 3042, 3061 and 3062	3/4"	■	■	■	Retrofits only	■	■	6213	.[Finish]	\$988	\$925	\$958	\$958	\$933	\$908
6214 - Retrofits FA 310-2/3/4	3/4"	■	■	■	■	■	■	6214	.[Finish]	\$1,117	\$1,054	\$1,087	\$1,087	\$1,062	\$1,037
6215 - Retrofits FA 310-2	3/4"	■	■	■	■	■	■	6215	.[Finish]	\$1,009	\$946	\$979	\$979	\$954	\$929
6216 - Retrofits FA 310-3-1. For mortise with manually operated deadbolt - 1" throw	3/4"	■	■	■	■	■	■	6216	.[Finish]	\$1,260	\$1,197	\$1,230	\$1,230	\$1,205	\$1,180
6221 - Retrofits VD 3071 and 3072. 4-3/4" minimum stile required	3/4"	■	■	■	■	■	■	6221	.[Finish]	\$1,122	\$1,059	\$1,092	\$1,092	\$1,067	\$1,042
6222 - Retrofits FA 310-2/3/4 OB	3/4"	■	■	■	■	■	■	6222	.[Finish]	\$1,399	\$1,336	\$1,369	\$1,369	\$1,344	\$1,319
6223 - Retrofits VD 3091 and 3092. 4-3/4" minimum stile required	3/4"	■	■	■	■	■	■	6223	.[Finish]	\$968	\$905	\$938	\$938	\$913	\$888

ELECTRIC STRIKES

605	606	611	612	613	619	622	625	626	626AM	628	629
US3	US4	US9	US10	US10B	US15	US19	US26	US26D	US26DAM	US28	US32
630	630AM	643e	689	691	693	695	706	710	711	721	728
US32D	US32DAM	-	SP28	SP10	SPBLK	SP313	SP4	313	315	US3A	US4A

6200 SERIES

6200 SERIES ELECTRIC STRIKES FOR MORTISE OR CYLINDRICAL LOCKS

Description	Throw	Fire rated	Hollow metal	Wood	Aluminum	Single	Mullion pair	Model	Finish	605	606	612	613	629	630
6224 - Retrofits FA 310-2 3/4. For door thicknesses 1-3/4" or 2-1/4"	3/4"	■	■		■		■	6224	[Finish]	\$1,130	\$1,067	\$1,100	\$1,100	\$1,075	\$1,050
6224AL - Retrofits FA 310-2RF. For door thicknesses 1-3/4" or 2-1/4"	3/4"	■			■		■	6224AL	[Finish]	\$1,145	\$1,082	\$1,115	\$1,115	\$1,090	\$1,065
6225 - Retrofits FA 310-2 OB	3/4"	■	■		■		■	6225	[Finish]	\$1,325	\$1,262	\$1,295	\$1,295	\$1,270	\$1,245
6226 - Retrofits FA 310-2. For door thicknesses 1-3/4" or 2-1/4"	3/4"	■	■		■		■	6226	[Finish]	\$968	\$905	\$938	\$938	\$913	\$888

OPTIONS

OPTIONS (PLEASE SPECIFY):		Specify	Price each
Fail Safe	Fail secure (FSE) is standard unless FS is specified	FS	\$43.00
Dual monitor switch	For latch bolt and lock status. Not available on 6221, 6222 & 6225	DS	\$211.00
Low current dual monitor switch	For latch bolt and lock status. 50 mA or less at 24 VDC (Not available on 6221, 6222 & 6225)	DS-LC	\$211.00
SO12 Rectifier Kit	Converts 12 VAC to 12 VDC (For 16 VAC current, use SO24 rectifier kit)	12 VAC	\$45.00
SO24 Rectifier Kit	Converts 24 VAC to 24 VDC	24 VAC	\$45.00
Shim for blade stop applications	Available as specified item with 6111 and 6113 only	SHIM	\$178.00
Entry Buzzer	Use in fail-secure applications	EB	\$44.00
Allegion Connect	6" wire extension harness connector	CON	\$0.00

Refer to the Electric Strike Parts section for a complete list of available parts.

NOTE: SO rectifier kit intended for fail secure / momentary use only. Contact product support for assistance.

Features

- Furnished standard in fail secure configuration unless specified fail safe (see options)
- 24 VDC supplied standard if not specified otherwise (see options)
- Compatible with mortise (without deadbolt) and cylindrical lock applications except where noted
- ANSI/BHMA 156.31 Grade 1: 6211, 6211AL and 6211WF
- UL10C fire rated (fail secure only)
- UL1034 burglary-resistant

ELECTRIC STRIKES

605	606	611	612	613	619	622	625	626	626AM	628	629
US3	US4	US9	US10	US10B	US15	US19	US26	US26D	US26DAM	US28	US32
630	630AM	643e	689	691	693	695	706	710	711	721	728
US32D	US32DAM	-	SP28	SP10	SPBLK	SP313	SP4	313	315	US3A	US4A

6300 SERIES

6300 SERIES SURFACE MOUNT ELECTRIC STRIKE FOR RIM EXIT DEVICES

Description	Throw	Fire Rated	Hollow Metal	Wood	Aluminum	Single	Mullion Pair	Model	Finish	630
6300 - No cut, surface mount design	Up to 3/4"	■	■	■	■	■	■	6300	.[Finish]	\$798

OPTIONS

OPTIONS		Specify	Price each
1/16" Shim	Can be ordered separately as part 050804-00	SHIM	\$68.00
SO12 Rectifier Kit	Converts 12 VAC to 12 VDC	12 VAC	\$45.00
SO24 Rectifier Kit	Converts 24 VAC to 24 VDC	24 VAC	\$45.00
Entry Buzzer	Use in fail-secure applications	EB	\$44.00

Included with strike: two plug-in voltage connectors, mounting template, spacer plate, mounting screws, and hex wrench. Refer to the Electric Strike Parts section for a complete list of available parts.

NOTE: SO rectifier kit intended for fail secure / momentary use only. Contact product support for assistance.

Features

- Dual voltage: 12 VDC at 500 mA / 24 VDC at 240 mA
- UL 1034, UL 294, CSFM
- Compatible with most rim exit devices
- UL 10C 3-hour fire rated (fail secure only)

6400 SERIES

6400 SERIES MODULAR ELECTRIC STRIKE FOR MORTISE OR CYLINDRICAL LOCKS

Description	Throw	Fire Rated	Hollow Metal	Wood	Aluminum	Single	Mullion Pair	Model	Finish	630
6400 - Up to 1" deadbolt throw (as night latch only)	Up to 3/4"	■	■	■	■	■		6400	.[Finish]	\$562

OPTIONS

OPTIONS		Specify	Price each
Latch Monitor	Optional plug-in latch monitor can be added in the field	LM6400	\$60.00
SO12 Rectifier Kit	Converts 12 VAC to 12 VDC	12 VAC	\$45.00
SO24 Rectifier Kit	Converts 24 VAC to 24 VDC	24 VAC	\$45.00
Entry Buzzer	Use in fail-secure applications	EB	\$44.00

Included with strike: two plug-in voltage connectors, self-adhesive template for frame cuts, trim filler plate, mounting tabs and shims, as well as tamper-resistant screws with a security driver bit.

NOTE: SO rectifier kit intended for fail secure / momentary use only. Contact product support for assistance.

Features

- Dual voltage: 12 VDC at 375 mA / 24 VDC at 190 mA
- ANSI/BHMA 156.31 Grade 1
- Modular options fit cylindrical and nearly any mortise lock
- UL 1034, UL 294, CSFM
- Includes movable deadbolt keeper, plug and deadlatch ramp inserts.
- 3-hour fire rated to UL 10C (fail secure only)

ELECTRIC STRIKES

605	606	611	612	613	619	622	625	626	626AM	628	629
US3	US4	US9	US10	US10B	US15	US19	US26	US26D	US26DAM	US28	US32
630	630AM	643e	689	691	693	695	706	710	711	721	728
US32D	US32DAM	-	SP28	SP10	SPBLK	SP313	SP4	313	315	US3A	US4A

MONITOR STRIKES

MONITOR STRIKES									
Description	Specify		626	613	606 612	605	625	629	630
	Model number	Finish							
For Rim type exit device as per catalog	4263-T1	.[Finish]	\$448.00	\$438.00	\$412.00	\$454.00	\$485.00	-	-
For Rim type exit device as per catalog	4263-T3	.[Finish]	\$448.00	\$438.00	\$412.00	\$454.00	\$485.00	-	-
For Rim type exit device as per catalog	4268-T1	.[Finish]	-	\$589.00	\$563.00	-	-	\$635.00	\$599.00
For Mortise Locks as per catalog - specify handing	4582-T1	.[Finish]	\$464.00	\$438.00	\$428.00	\$470.00	\$501.00	-	-
For Mortise Locks as per catalog - specify handing	4582-T2	.[Finish]	\$464.00	\$454.00	\$428.00	\$470.00	\$501.00	-	-
For Cylindrical/Mortise Locks as per catalog	4570-T1	.[Finish]	\$464.00	\$454.00	\$428.00	\$470.00	\$501.00	-	-
For Cylindrical Locks as per catalog	4670-T1	.[Finish]	\$448.00	\$454.00	\$412.00	\$454.00	\$485.00	-	-
For Single 3347A, 3547A, 9847, and 9947	4690-T2	.[Finish]	\$655.00	\$645.00	\$619.00	\$661.00	\$692.00	-	-
Special Twin for 3347A and 3547A Device (2 1/4" cc)	4690-T2-1	.[Finish]	\$1,190.00	\$1,180.00	\$1,154.00	\$1,196.00	\$1,227.00	-	-

SCHLAGE® ELECTRONIC EXIT TRIM

AD Series Electronic Exit Trim is available on XP98/99 and Series 98/99 for rim, mortise, surface vertical, and concealed vertical rod/concealed vertical cable, and Series 22/22F for rim and surface vertical rod devices. For AD-300/400 network trim the Von Duprin RX-LC switch (part #050281) must be used or the warranty is void.

Four communication options:

- AD-200 993 Offline, access rights stored on lock.
- AD-250 993 Offline, access rights on stored magnetic stripe credential.
- AD-300 993 Networked Hardwire Locks
- AD-400 993 Networked Wireless Locks



For complete pricing information refer to Schlage Electronic Security Price Book #010056.

NOTE: CVR/CVC trim is available only on metal doors.

PARTS AND ACCESSORIES

605	606	611	612	613	619	622	625	626	626AM	628	629
US3	US4	US9	US10	US10B	US15	US19	US26	US26D	US26DAM	US28	US32
630	630AM	643e	689	691	693	695	706	710	711	721	728
US32D	US32DAM	-	SP28	SPIO	SPBLK	SP313	SP4	313	315	US3A	US4A

BOX ASSEMBLIES

Description	Part number	List Price
6111, 6113, 6213 12VDC FS Box Assembly	111743	\$421.00
6111, 6113, 6213 12VDC FSE Box Assembly	111744	\$421.00
6111, 6113, 6213 24VDC FS Box Assembly	111745	\$421.00
6111, 6113, 6213 24VDC FSE Box Assembly	111746	\$421.00
6111, 6113, 6213 12VDC FS DS Box Assembly	111747	\$612.00
6111, 6113, 6213 12VDC FSE DS Box Assembly	111748	\$612.00
6111, 6113, 6213 24VDC FS DS Box Assembly	111749	\$612.00
6111, 6113, 6213 24VDC FSE DS Box Assembly	111750	\$612.00
6111, 6113, 6213 12VDC FS DS-LC Box Assembly	112772	\$612.00
6111, 6113, 6213 12VDC FSE DS-LC Box Assembly	112773	\$612.00
6111, 6113, 6213 24VDC FS DS-LC Box Assembly	112774	\$612.00
6111, 6113, 6213 24VDC FSE DS-LC Box Assembly	112775	\$612.00
6112, 6121 12VDC FS Box Assembly	111751	\$412.00
6112, 6121 12VDC FSE Box Assembly	111752	\$412.00
6112, 6121 24VDC FS Box Assembly	111753	\$412.00
6112, 6121 24VDC FSE Box Assembly	111754	\$412.00
6112, 6121 12VDC FS DS Box Assembly	111755	\$599.00
6112, 6121 12VDC FSE DS Box Assembly	111756	\$599.00
6112, 6121 24VDC FS DS Box Assembly	111757	\$599.00
6112, 6121 24VDC FSE DS Box Assembly	111758	\$599.00
6112, 6121 12VDC FS DS-LC Box Assembly	112776	\$599.00
6112, 6121 12VDC FSE DS-LC Box Assembly	112777	\$599.00
6112, 6121 24VDC FS DS-LC Box Assembly	112778	\$599.00
6112, 6121 24VDC FSE DS-LC Box Assembly	112779	\$599.00
6114, 6214/15, 6222/24/24AL/25/26 12VDC FS Box Assembly	111719	\$464.00
6114, 6214/15, 6222/24/24AL/25/26 12VDC FSE Box Assembly	111720	\$464.00
6114, 6214/15, 6222/24/24AL/25/26 24VDC FS Box Assembly	111721	\$464.00
6114, 6214/15, 6222/24/24AL/25/26 24VDC FSE Box Assembly	111722	\$464.00
6114, 6214/15, 6224/24AL/26 12VDC FS DS Box Assembly	111723	\$655.00
6114, 6214/15, 6224/24AL/26 12VDC FSE DS Box Assembly	111724	\$655.00
6114, 6214/15, 6224/24AL/26 24VDC FS DS Box Assembly	111725	\$655.00
6114, 6214/15, 6224/24AL/26 24VDC FSE DS Box Assembly	111726	\$655.00
6114, 6214/15/24/24AL/26 12VDC FS DS-LC Box Assembly	112760	\$655.00
6114, 6214/15/24/24AL/26 12VDC FSE DS-LC Box Assembly	112761	\$655.00
6114, 6214/15/24/24AL/26 24VDC FS DS-LC Box Assembly	112762	\$655.00
6114, 6214/15/24/24AL/26 24VDC FSE DS-LC Box Assembly	112763	\$655.00
6210 12VDC FS Box Assembly	111244	\$685.00
6210 12VDC FSE Box Assembly	111246	\$420.00
6210 24VDC FS Box Assembly	111247	\$475.00
6210 24VDC FSE Box Assembly	111250	\$345.00
6210 12VDC FS DS Box Assembly	111251	\$873.00
6210 12VDC FSE DS Box Assembly	111264	\$610.00
6210 24VDC FS DS Box Assembly	111813	\$671.00
6210 24VDC FSE DS Box Assembly	111814	\$671.00

PARTS AND ACCESSORIES

605	606	611	612	613	619	622	625	626	626AM	628	629
US3	US4	US9	US10	US10B	US15	US19	US26	US26D	US26DAM	US28	US32
630	630AM	643e	689	691	693	695	706	710	711	721	728
US32D	US32DAM	-	SP28	SP10	SPBLK	SP313	SP4	313	315	US3A	US4A

BOX ASSEMBLIES

Description	Part number	List Price
6210 12VDC FS DS-LC Box Assembly	112754	\$619.00
6210 12VDC FSE DS-LC Box Assembly	112755	\$619.00
6210 24VDC FS DS-LC Box Assembly	112784	\$619.00
6210 24VDC FSE DS-LC Box Assembly	112785	\$619.00
6211, 6211AL, 6212 12VDC FS Box Assembly	111711	\$396.00
6211, 6211AL, 6212 12VDC FSE Box Assembly	111712	\$396.00
6211, 6211AL, 6212 24VDC FS Box Assembly	111713	\$396.00
6211, 6211AL, 6212 24VDC FSE Box Assembly	111714	\$396.00
6211, 6211AL, 6212 12VDC FS DS Box Assembly	111715	\$590.00
6211, 6211AL, 6212 12VDC FSE DS Box Assembly	111716	\$590.00
6211, 6211AL, 6212 24VDC FS DS Box Assembly	111717	\$590.00
6211, 6211AL, 6212 24VDC FSE DS Box Assembly	111718	\$590.00
6211WF, 6212WF 12VDC FS Box Assembly	111727	\$420.00
6211WF, 6212WF 12VDC FSE Box Assembly	111728	\$420.00
6211WF, 6212WF 24VDC FS Box Assembly	111729	\$420.00
6211WF, 6212WF 24VDC FSE Box Assembly	111730	\$420.00
6211WF, 6212WF 12VDC FS DS Box Assembly	111731	\$610.00
6211WF, 6212WF 12VDC FSE DS Box Assembly	111732	\$610.00
6211WF, 6212WF 24VDC FS DS Box Assembly	111733	\$610.00
6211WF, 6212WF 24VDC FSE DS Box Assembly	111734	\$610.00
6211WF, 6212WF 12VDC FS DS-LC Box Assembly	112764	\$610.00
6211WF, 6212WF 12VDC FSE DS-LC Box Assembly	112765	\$610.00
6211WF, 6212WF 24VDC FS DS-LC Box Assembly	112766	\$610.00
6211WF, 6212WF 24VDC FSE DS-LC Box Assembly	112767	\$610.00
6211, 6211AL, 6212 12VDC FS DS-LC Box Assembly	112756	\$590.00
6211, 6211AL, 6212 12VDC FSE DS-LC Box Assembly	112757	\$590.00
6211, 6211AL, 6212 24VDC FS DS-LC Box Assembly	112758	\$590.00
6211, 6211AL, 6212 24VDC FSE DS-LC Box Assembly	112759	\$590.00
6216 12VDC FS Box Assembly	111759	\$421.00
6216 12VDC FSE Box Assembly	111760	\$421.00
6216 24VDC FS Box Assembly	111761	\$421.00
6216 24VDC FSE Box Assembly	111762	\$421.00
6216 12VDC FS DS Box Assembly	111763	\$612.00
6216 12VDC FSE DS Box Assembly	111764	\$612.00
6216 24VDC FS DS Box Assembly	111765	\$612.00
6216 24VDC FSE DS Box Assembly	111766	\$612.00
6216 12VDC FS DS-LC Box Assembly	112780	\$612.00
6216 12VDC FSE DS-LC Box Assembly	112781	\$612.00
6216 24VDC FS DS-LC Box Assembly	112782	\$612.00
6216 24VDC FSE DS-LC Box Assembly	112783	\$612.00
6221, 6223 12VDC FS Box Assembly	111735	\$433.00
6221, 6223 12VDC FSE Box Assembly	111736	\$433.00
6221, 6223 24VDC FS Box Assembly	111737	\$433.00
6221, 6223 24VDC FSE Box Assembly	111738	\$433.00

PARTS AND ACCESSORIES

605	606	611	612	613	619	622	625	626	626AM	628	629
US3	US4	US9	US10	US10B	US15	US19	US26	US26D	US26DAM	US28	US32
630	630AM	643e	689	691	693	695	706	710	711	721	728
US32D	US32DAM	-	SP28	SP10	SPBLK	SP313	SP4	313	315	US3A	US4A

BOX ASSEMBLIES

Description	Part number	List Price
6223 12VDC FS DS Box Assembly	111739	\$626.00
6223 12VDC FSE DS Box Assembly	111740	\$626.00
6223 24VDC FS DS Box Assembly	111741	\$626.00
6223 24VDC FSE DS Box Assembly	111742	\$626.00
6223 12VDC FS DS-LC Box Assembly	112768	\$626.00
6223 12VDC FSE DS-LC Box Assembly	112769	\$626.00
6223 24VDC FS DS-LC Box Assembly	112770	\$626.00
6223 24VDC FSE DS-LC Box Assembly	112771	\$626.00

DUAL MONITOR SWITCH REPLACEMENT KITS

Description	Part number	List Price
6100, 6200 DS Replacement Kit Type A – Standard Back Box	050011	\$237.00
6100, 6200 DS Replacement Kit Type B – Special Back Box	050015	\$237.00
6100, 6200 DS-LC Replacement Kit Type A – Standard Back Box	050016	\$237.00
6100, 6200 DS-LC Replacement Kit Type B – Special Back Box	050018	\$237.00

FACEPLATES

Description	Specify		622, 689, 695	630	612, 613	606	605	629
	Part number	Finish						
4200 Faceplate, Round Corner	090110	.[Finish]	-	\$21.00	-	-	-	-
4200 Faceplate, Square Corner	090114	.[Finish]	-	\$21.00	-	-	-	-
5100 Faceplate Package - Standard 4 7/8"	050031	-	\$29.00	-	-	-	-	-
5100 Faceplate Package - Round Corner 4 7/8"	050032	-	\$29.00	-	-	-	-	-
5100 Faceplate Package – Long 7 15/16"	050033	-	\$29.00	-	-	-	-	-
6111 Faceplate	970271	.[Finish]	-	\$433.00	\$476.00	\$433.00	\$592.00	\$497.00
6112, 6121 Faceplate	970303	.[Finish]	-	\$394.00	\$509.00	\$394.00	\$600.00	\$350.00
6113 Faceplate	970280	.[Finish]	-	\$428.00	\$444.00	\$428.00	\$581.00	\$444.00
6114 Faceplate	970300	.[Finish]	-	\$357.00	\$441.00	\$401.00	\$497.00	\$371.00
6210 Faceplate	971198	.[Finish]	-	\$296.00	\$417.00	\$296.00	\$473.00	\$401.00
6211AL Faceplate	970272	.[Finish]	-	\$376.00	\$441.00	\$376.00	\$531.00	\$384.00
6211, 6211WF Faceplate	968716	.[Finish]	-	\$312.00	\$355.00	\$312.00	\$445.00	\$316.00
6212, 6212WF Faceplate	969584	.[Finish]	-	\$445.00	\$499.00	\$445.00	\$548.00	\$506.00
6213 Faceplate	970278	.[Finish]	-	\$413.00	\$449.00	\$413.00	\$554.00	\$449.00
6214 Faceplate	971417	.[Finish]	-	\$488.00	\$517.00	\$474.00	\$662.00	\$509.00
6215 Faceplate	971415	.[Finish]	-	\$393.00	\$441.00	\$393.00	\$517.00	\$401.00
6216 Large Faceplate Insert	970407	.[Finish]	-	\$115.00	\$134.00	\$115.00	\$161.00	\$140.00
6216 Small Faceplate Insert	970415	.[Finish]	-	\$115.00	\$134.00	\$115.00	\$161.00	\$140.00
6216 Faceplate Less Inserts	971385	.[Finish]	-	\$538.00	\$564.00	\$538.00	\$758.00	\$522.00
6221 Faceplate	970276	.[Finish]	-	\$523.00	\$575.00	\$523.00	\$627.00	\$596.00
6222 Faceplate	970305	.[Finish]	-	\$756.00	\$804.00	\$756.00	\$1,025.00	\$756.00
6223 Faceplate	970274	.[Finish]	-	\$376.00	\$434.00	\$376.00	\$542.00	\$434.00

PARTS AND ACCESSORIES

605	606	611	612	613	619	622	625	626	626AM	628	629
US3	US4	US9	US10	US10B	US15	US19	US26	US26D	US26DAM	US28	US32
630	630AM	643e	689	691	693	695	706	710	711	721	728
US32D	US32DAM	-	SP28	SP10	SPBLK	SP313	SP4	313	315	US3A	US4A

FACEPLATES

Description	Specify		622, 689, 695	630	612, 613	606	605	629
	Part number	Finish						
6224 Faceplate	970302	.[Finish]	-	\$503.00	\$526.00	\$488.00	\$675.00	\$520.00
6224AL Faceplate	970310	.[Finish]	-	\$517.00	\$573.00	\$517.00	\$718.00	\$526.00
6225 Faceplate	970306	.[Finish]	-	\$684.00	\$725.00	\$684.00	\$825.00	\$756.00
6226 Faceplate	970301	.[Finish]	-	\$350.00	\$397.00	\$350.00	\$513.00	\$360.00

SCREW AND MOUNTING PACKAGES

Description	Specify		Non-Finished	630	612, 613	606	605	629
	Part number	Finish						
4200 Hardware Kit (includes: mounting tab hardware, mounting screws, allen wrench and diode)	050805	-	\$17.00	-	-	-	-	-
5100 Mounting Package	PKGMTG.1004	.[Finish]	-	\$15.00	-	-	-	-
5100 Mounting Package (Black)	PKGMTG.1005	-	\$15.00	-	-	-	-	-
5100 Series Screw Package	PKGSCR.1003	.[Finish]	-	\$15.00	-	-	-	-
5100 Series Screw Package (Black)	PKGSCR.1004	-	\$15.00	-	-	-	-	-
6111, 6113 Screw Package	900870	.[Finish]	-	\$13.00	\$13.00	\$13.00	\$13.00	\$13.00
6112, 6121 Screw Package	900881	.[Finish]	-	\$14.00	\$15.00	\$15.00	\$15.00	\$15.00
6114 Screw Package	900882	.[Finish]	-	\$14.00	\$15.00	\$15.00	\$15.00	\$15.00
6210 Strike Pocket Insert Mounting Package	900966	-	\$12.00	-	-	-	-	-
6210/11/13/14/16, 6222/24/25/26 Screw Package	900288	.[Finish]	-	\$15.00	\$15.00	\$15.00	\$15.00	\$15.00
6211WF, 6212WF, 6221/23 Screw Package	900885	.[Finish]	-	\$13.00	\$13.00	\$13.00	\$13.00	\$13.00
6212 Screw Package	900290	.[Finish]	-	\$14.00	\$14.00	\$14.00	\$14.00	\$14.00
6216 Inserts and Screw Package	900345	-	\$282.00	-	-	-	-	-
Screw: 8-32 x 3/8" PPHMS	964070	-	\$12.00	-	-	-	-	-
Screw: 6-32 x 3/8" PPHMS Type 2A	964190	-	\$12.00	-	-	-	-	-

SOLENOID PARTS

Description	Part number	List Price
5100 Solenoid Kit 12/24VDC	050034	\$80.00
6100, 6200 Series Solenoid Kit 12VDC (FS & FSE)	050237	\$123.00
6100, 6200 Series Solenoid Kit 16 VDC (FS & FSE)	050239	\$123.00
6100, 6200 Series Solenoid Kit 24VDC (FS & FSE)	050240	\$123.00
6100, 6200 Series Solenoid Kit 28VDC	050699	\$120.00
Solenoid Spring	968713	\$14.00
Solenoid Washer	964037	\$12.00

PARTS AND ACCESSORIES

605	606	611	612	613	619	622	625	626	626AM	628	629
US3	US4	US9	US10	US10B	US15	US19	US26	US26D	US26DAM	US28	US32
630	630AM	643e	689	691	693	695	706	710	711	721	728
US32D	US32DAM	-	SP28	SP10	SPBLK	SP313	SP4	313	315	US3A	US4A

SPRING KITS

Description	Part number	List Price
6111/13, 6213, 6221/23 Spring Kit	050942	\$37.00
6112/14/21, 6214/15/22/24/24AL/25/26 Spring Kit	050943	\$37.00
6210 Spring Kit	050940	\$44.00
6211/12 Spring Kit	050939	\$37.00
6216 Spring Kit	050941	\$44.00

MISCELLANEOUS HARDWARE

Description	Specify		Non-Finished	606, 612, 613, 630	605	629	689, 695
	Part number	Finish					
#8 Ext. Tooth Lock Washer	964019	-	\$12.00	-	-	-	-
4200 Hardware Kit (includes: mounting tab hardware, mounting screws, allen wrench and diode)	050805	-	\$17.00	-	-	-	-
Entry Buzzer (FSE application only)	050242	-	\$44.00	-	-	-	-
12 VAC to 12 VDC Rectifier Kit	010057	-	\$45.00	-	-	-	-
24 VAC to 24 VDC Rectifier Kit	010058	-	\$45.00	-	-	-	-
6100, 6200 Series DS-LC Switch and Clip Assembly	113232	-	\$188.00	-	-	-	-
6111, 6113 Shim for blade stop applications	010055	[Finish]	-	-	-	-	\$178.00
6113 Frame Insert Package	900347	-	\$12.00	-	-	-	-
6121 Housing Cover	970412	[Finish]	-	\$390.00	\$513.00	\$523.00	-
6210 Auxiliary Bolt Plate Package	900584	-	\$42.00	-	-	-	-
6212 Strike Pocket Insert/Mounting Tab	900292	-	\$31.00	-	-	-	-
6216 Inserts and Screw Package	900345	-	\$282.00	-	-	-	-
6300, 6400 Cable (Pigtail) Kit	050803	-	\$54.00	-	-	-	-
6300 Strike Shim - 1/16"	050804	-	\$68.00	-	-	-	-
6100, 6200 (9100) Filler Bracket Kit	050749	-	\$58.00	-	-	-	-
Connector	990132	-	\$12.00	-	-	-	-
DS Tripper Extension & Connector	900344	-	\$31.00	-	-	-	-
DS Tripper Extension	970384	-	\$13.00	-	-	-	-
FS Slider (All 6100 and 6200 Series models except 6211WF/6212WF/6221/6223)	090591	-	\$37.00	-	-	-	-
FSE Slider (Models 6211WF/6212WF/6221/6223)	090591	-	\$37.00	-	-	-	-
FSE Slider (All 6100 and 6200 Series models except 6211WF/6212WF/6221/6223)	090798	-	\$37.00	-	-	-	-
FS Slider (Models 6211WF/6212WF/6221/6223)	090798	-	\$37.00	-	-	-	-
6400 Hardware Kit	050819	-	\$87.00	-	-	-	-

ELECTRIFIED KITS

605	606	611	612	613	619	622	625	626	626AM	628	629
US3	US4	US9	US10	US10B	US15	US19	US26	US26D	US26DAM	US28	US32
630	630AM	643e	689	691	693	695	706	710	711	721	728
US32D	US32DAM	-	SP28	SP10	SPBLK	SP313	SP4	313	315	US3A	US4A

PARTS AND ACCESSORIES

ELECTRIC LATCH RETRACTION		
Description	Part number	List Price
EL Dogging Rod - 3'	050531	\$67.00
EL Dogging Rod - 4'	050532	\$67.00
EL Dogging Rod Retainer	050538	\$15.00
EL Solenoid & Plunger	050535	\$371.00
HD-EL Solenoid	050536	\$371.00
HD-EL Solenoid Plunger	050537	\$136.00
EL Plunger Bracket-94/95	972471	\$33.00
Pulse Width Module	050534	\$327.00
QEL/MEL motor cable with 6' harness	47269206	\$62.00
EL Receptacle Connector	050539	\$14.00
EL Female Terminal	050540	\$14.00
HD-EL Dog Screw	050541	\$17.00
HD-EL Dogging Spring	050543	\$17.00
HD-EL Solenoid Bracket	050542	\$30.00
QEL Cable Package (includes short QEL motor cable)	114320	\$13.00
QEL Extended Cable Assembly (includes QEL 6' cable and short QEL motor cable)	116549	\$62.00
QEL Motor Cable with QEL CON Adapter Harness	040069	\$62.00
6000 Strike Solenoid CON Adapter Harness	106187	\$15.00
E7500 Solenoid/QEL/EL CON Adapter Harness	106198	\$13.00
EL Baseplate Conversion Kit 3'	050070	\$1,184.00
EL Baseplate Conversion Kit 4'	050078	\$1,184.00
EL Baseplate Conversion Kit 3' with Allegion Connect - CON	050853	\$1,184.00
EL Baseplate Conversion Kit 4' with Allegion Connect - CON	050854	\$1,184.00
HD-EL Baseplate Conversion Kit 3' (Hex Dogging included - Panic Only)	050384	\$1,184.00
HD-EL Baseplate Conversion Kit 4' (Hex Dogging included - Panic Only)	050385	\$1,184.00
HD-EL Baseplate Conversion Kit 3' (Hex Dogging included - Panic Only) with Allegion Connect - CON	050855	\$1,184.00
HD-EL Baseplate Conversion Kit 4' (Hex Dogging included - Panic Only) with Allegion Connect - CON	050856	\$1,184.00
QEL Modular Conversion Kit	114317	\$979.00
QEL Modular Conversion Kit with Allegion Connect - CON	040061	\$979.00
QELX Modular Conversion Kit for AX devices	041162	\$1,041.00
QELX Modular Conversion Kit for AX devices with Allegion Connect -CON	041163	\$1,041.00
HD-QEL Modular Conversion Kit (Hex Dogging included - Panic Only)	958002	\$979.00
HD-QEL Modular Conversion Kit (Hex Dogging included - Panic Only) with Allegion Connect - CON	040062	\$979.00
HD-QELX Modular Conversion Kit for AX devices (Hex Dogging Included - Panic Only)	041164	\$1,041.00
HD-QELX Modular Conversion Kit for AX devices (Hex Dogging Included - Panic Only) with Allegion Connect -CON	041165	\$1,041.00
QEL Baseplate Conversion Kit 3'	958003	\$1,029.00
QEL Baseplate Conversion Kit 4'	040065	\$1,029.00
QEL Baseplate Conversion Kit 3' with Allegion Connect - CON	040063	\$1,029.00
QEL Baseplate Conversion Kit 4' with Allegion Connect - CON	040066	\$1,029.00

PARTS AND ACCESSORIES

605	606	611	612	613	619	622	625	626	626AM	628	629
US3	US4	US9	US10	US10B	US15	US19	US26	US26D	US26DAM	US28	US32
630	630AM	643e	689	691	693	695	706	710	711	721	728
US32D	US32DAM	-	SP28	SP10	SPBLK	SP313	SP4	313	315	US3A	US4A

ELECTRIC LATCH RETRACTION

Description	Part number	List Price
QELX Baseplate Conversion Kit for AX devices 3'	041166	\$1,091.00
QELX Baseplate Conversion Kit for AX devices 4'	041167	\$1,091.00
QELX Baseplate Conversion Kit for AX devices 3' with Allegion Connect -CON	041168	\$1,091.00
QELX Baseplate Conversion Kit for AX devices 4' with Allegion Connect -CON	041169	\$1,091.00
HD-QEL Baseplate Conversion Kit 3' (Hex Dogging included - Panic Only)	958004	\$1,029.00
HD-QEL Baseplate Conversion Kit 4' (Hex Dogging included - Panic Only)	040067	\$1,029.00
HD-QEL Baseplate Conversion Kit 3' (Hex Dogging included - Panic Only) with Allegion Connect - CON	040064	\$1,029.00
HD-QEL Baseplate Conversion Kit 4' (Hex Dogging included - Panic Only) with Allegion Connect - CON	040068	\$1,029.00
HD-QELX Baseplate Conversion Kit for AX devices 3' (Hex Dogging Included - Panic Only)	041170	\$1,091.00
HD-QELX Baseplate Conversion Kit for AX devices 4' (Hex Dogging Included - Panic Only)	041171	\$1,091.00
HD-QELX Baseplate Conversion Kit for AX devices 3' (Hex Dogging Included - Panic Only) with Allegion Connect -CON	041172	\$1,041.00
HD-QELX Baseplate Conversion Kit for AX devices 4' (Hex Dogging Included - Panic Only) with Allegion Connect -CON	041173	\$1,041.00
QEL 94/95 Inpact Modular Conversion Kit	958005	\$979.00

PNEUMATIC LATCH RETRACTION

Description	Part number	List Price
Pneumatic Power Transfer	012014	\$664.00
PN 5/32" Tubing - 25'	051828	\$27.00
PN 5/32" Tubing - 50'	051823	\$35.00
PN 5/32" Tubing - 100'	051824	\$60.00
PN 5/32" Tubing - 200'	051825	\$113.00
Pneumatic Solenoid Kit	051826	\$909.00
PN ADAPTER KIT - 5/32" to 1/4" LCN Tubing	051827	\$41.00

CHEXIT

Description	Specify		Non-finished	612, 605, 606, 628, 625	711, 643E, 710, 693	619, 630
	Part number	Finish				
Chexit PCB Kit - 15 second release	040086	-	\$1,099.00	-	-	-
Chexit PCB Kit - 30 second release	040088	-	\$1,243.00	-	-	-
Chexit PCB KIT - 0 Second Delay release	040089	-	\$1,243.00	-	-	-
Chexit PCB Kit - 15 Second Boca release	040091	-	\$1,243.00	-	-	-
Chexit CON Adapter Harness	116724	-	\$106.00	-	-	-
Chexit PCB Kit - Infinite Release	040087	-	\$1,243.00	-	-	-
DE5300/RCM PCB Kit - 15 Second release	090943	-	\$1,045.00	-	-	-
DE5300/RCM Key Switch Assy	040169	-	\$132.00	-	-	-
DE5300/RCM PCB Kit - 0 Second release	050899	-	\$1,189.00	-	-	-
RCM/DE5300 Cable Kit	040188	-	\$121.00	-	-	-
CX99-RCM Kit Less Module	040198	.[Finish]	-	\$278.00	\$278.00	-
CX98-RCM Kit Less Module	040199	.[Finish]	-	\$278.00	\$278.00	\$278.00

PARTS AND ACCESSORIES

605	606	611	612	613	619	622	625	626	626AM	628	629
US3	US4	US9	US10	US10B	US15	US19	US26	US26D	US26DAM	US28	US32
630	630AM	643e	689	691	693	695	706	710	711	721	728
US32D	US32DAM	-	SP28	SP10	SPBLK	SP313	SP4	313	315	US3A	US4A

CHEXIT

Description	Specify		Non-finished	612, 605, 606, 628, 625	711, 643E, 710, 693	619, 630
	Part number	Finish				
CX-RCM Cable Assy	040092	-	\$74.00	-	-	-
Chexit Wiring Assembly	040191	-	\$211.00	-	-	-
Sign 15 Second - Chexit/DE5300	113781	-	\$62.00	-	-	-
Sign 30 Second - Chexit/DE5300	113782	-	\$67.00	-	-	-
CX Motor Cable Kit	040192	-	\$13.00	-	-	-
CX Trim Device Cable Kit	040193	-	\$25.00	-	-	-
CX RX Switch Assembly Kit	116717	-	\$253.00	-	-	-
CX Key Switch Assy 3' Device	040170	-	\$127.00	-	-	-
CX Key Switch Assy 4' Device	040189	-	\$127.00	-	-	-
CX Wire Guard	47267412	-	\$47.00	-	-	-

SWITCH

Description	Part number	List Price
LX-RX 94/95 Switch Wire Assembly (R/Y/B)	110360	\$121.00
SS Cable	050544	\$146.00
SS Housing	050545	\$487.00
RX Switch Assy	050251	\$266.00
RX-LC Switch Assy	050281	\$309.00
RX-2 Switch Assy	050270	\$331.00
RX-Aux Switch Assy	050271	\$277.00
WP-RX-AUX Switch Assy	051881	\$384.00
LX Switch Assy 3'	050254	\$266.00
LX Switch Assy 4'	050255	\$266.00
LX-LC Switch Assy 3'	050283	\$309.00
LX-LC Switch Assy 4'	050285	\$309.00
LX-RX Switch Assy 3'	050256	\$402.00
LX-RX Switch Assy 4'	050257	\$402.00
LX-RX-LC Switch Assy 3'	050289	\$483.00
LX-RX-LC Switch Assy 4'	050291	\$483.00
EL-LX Switch Assy	050247	\$266.00
EL-LX-LC Switch Assy	050287	\$309.00
EL-LX-RX Switch Assy	050259	\$402.00
EL-LX-RX-LC Switch Assy	050293	\$483.00
94/95 Inpact LX Switch Kit	050226	\$266.00

Consult technical support for details.

PARTS AND ACCESSORIES

605	606	611	612	613	619	622	625	626	626AM	628	629
US3	US4	US9	US10	US10B	US15	US19	US26	US26D	US26DAM	US28	US32
630	630AM	643e	689	691	693	695	706	710	711	721	728
US32D	US32DAM	-	SP28	SP10	SPBLK	SP313	SP4	313	315	US3A	US4A

E360 CONTROLS

Description	Specify		Non-finished	689 695
	Part number	Finish		
E360 FSE SOLENOID KIT	050743	-	\$675.00	-
E360 FS SOLENOID KIT	050744	-	\$675.00	-

M996 TRIMS

Description	Specify		Non-finished	689 695
	Part number	Finish		
M996 Mort Conv to Motorized Kit	47273112	-	\$770.00	-
M996 R/V/C Conv to Motorized Kit	47273111	-	\$740.00	-
M996 Wire Harness	CABLE.10038	-	\$50.00	-
M996 CON Adapter Harness	106183	-	\$36.00	-

MISCELLANEOUS

Description	Specify		Non-Finished	689, 695
	Part number	Finish		
Switch Cover Assy - 4000 Monitor Strikes	105100	-	\$142.00	-
EPT Filler Kit	900978	.[Finish]	-	\$30.00
900-BAT Power Supply Batteries	44487155	-	\$131.00	-
PS914 Enclosure Door Label	44489870	-	\$10.00	-

OLD P/N	NEW P/N	OLD P/N	NEW P/N	OLD P/N	NEW P/N	OLD P/N	NEW P/N
213	050342	101801	050456	106769	050316	111948	113100
011214	050338	101907	050418	106769	050318	111949	050506
011223	050343	102274	050139	106769	050324	111950	050504
011224	050339	102277	050137	106769	050326	112342	050575
011233	050340	102551	050036	106780	050493	112461	111869
011234	050336	102676	050462	107021	050750	112727	050491
011243	050341	102681	050463	107023	050592	112906	050494
011244	050337	102685	050432	107682	050451	112907	050495
011253	050350	102691	050430	107798	050456	112910	050583
011254	050346	102694	050431	108327	050402	112915	050535
011263	050351	102701	050446	108360	050513	112924	050401
011264	050347	102703	050202	108361	050515	112925	050400
011273	050348	102930	114141	108994	PBKIT.1001	113004	050732
011274	050344	103234	050455	108994	PBKIT.1002	113005	050733
011283	050349	104154	050411	108995	PBKIT.1003	113006	050734
011284	050345	104164	050428	108995	PBKIT.1004	113007	050736
050361	050360	104165	050429	109041	050537	113078	050737
061420	050005	104367	050210	109160	050128	113079	050738
062370	050459	104759	050053	109759	050492	113080	050739
090058	090065	105020	050457	109760	050754	113081	050741
100511	050200	105163	050110	109811	900620	113125	050548
100693	050209	105641	050096	109826	050366	113126	050549
100729	050439	105666	050458	109861	050357	113129	050550
100744	050438	106118	050440	110007	050531	113130	050551
100751	050497	106122	050441	110008	050532	113133	050552
100999	050442	106144	050372	110051	050401	113134	050553
101000	050443	106145	050374	110052	050400	114169	050516
101011	050201	106147	050373	110058	050402	945501	090001
101134	050112	106174	050437	110163	050756	950522	090012
101137	050136	106180	050452	110165	050757	951081	050476
101149	050368	106708	050295	110375	050574	951780	090013
101190	050367	106708	050296	110416	050582	951960	050501
101444	050444	106708	050297	110472	050544	951970	050502
101445	050445	106708	050298	110525	110769	952400	050448
101590	050498	106708	050303	110573	050512	952530	050447
101593	050424	106708	050304	110574	050514	956011	PKGSRV.1018
101594	050425	106708	050305	110658	050545	956520	090020
101598	050426	106708	050306	110740	050536	957750	050278
101599	050427	106725	050299	110741	050534	958643	090014
101648	050482	106725	050300	110767	971012	959098	113853
101662	050409	106725	050301	110783	971012	959122	972466
101665	050410	106725	050302	111645	050752	959707	971593
101686	050413	106725	050307	111651	050758	959850	050352
101689	050414	106725	050308	111657	050760	959853	050353
101695	050420	106725	050309	111669	050762	959957	050355
101695	050422	106725	050310	111675	050764	959958	050332
101698	050421	106847	050412	111795	101030	959969	050364
101698	050423	106763	050311	111931	050197	959986	050333
101701	050417	106763	050313	111932	050196	959990	090023
101704	050419	106763	050319	111933	050189	959991	050356
101707	050415	106763	050321	111934	050191	959995	050334
101710	050416	106765	050312	111935	050184	960049	090030
101713	050435	106765	050314	111936	050183	960303	970488
101716	050436	106765	050320	111937	050198	960345	050503
101750	050460	106765	050322	111938	050199	960548	050464
101751	050461	106767	050315	111940	050195	101777	050455
101752	050471	106767	050317	111941	050192	960578	050327
101753	050472	106767	050323	111942	050193	960581	050453

	OLD P/N	NEW P/N	OLD P/N	NEW P/N	OLD P/N	NEW P/N	OLD P/N	NEW P/N
	960652	050277	966384	050607	969816	050601	971267	050525
	960675	050499	966450	971614	969836	050555	971308	090038
	960756	050211	966897	050541	969837	050555	971326	050538
	960856	050260	967032	050490	969838	050556	971348	090088
	961152	050369	967116	90069	969839	050556	971351	090039
	961206	050465	967151	051705	969855	050566	971367	090047
	961218	050478	967154	051707	969864	050564	971424	050275
	961628	050453	967224	090011	969925	972466	971425	050276
	961814	050272	967448	090064	969987	050530	971483	050566
	961988	900614	967481	090097	969994	050474	971492	090040
	963011	900502	967482	050607	969995	050475	971495	090043
	963019	090035	967484	050599	970079	90048	971496	090045
	963094	090024	967489	050606	970086	050555	971507	090031
	963096	090025	967490	050609	970087	050555	971507	050585
	963098	900610	967492	050600	970088	050556	971537	090072
	963099	090002	967493	050602	970089	050556	971560	050406
	963100	050613	967495	090096	970126	970387	971561	050407
	963103	090015	967496	090090	970148	970388	971562	050570
	963128	090059	967502	050354	970173	968694	971564	050569
	963130	090032	967616	050328	970180	971556	971567	050546
	963155	090061	967622	050454	970181	971557	971568	050481
	963193	090016	967623	050454	970184	050621	971583	050611
	963512	090100	967644	050598	970193	050488	971583	PKGSRV.1010
	963531	050614	967648	050612	970194	050489	971584	090070
	963585	090010	967673	090095	970206	050554	971625	050554
	963712	900613	967736	050004	970207	050554	971627	050559
	963750	090018	967738	050004	970208	050554	971628	050560
	963757	090103	967826	090065	970368	050547	971629	050562
	963760	090098	967968	090062	970441	090074	971630	050562
	963789	090027	968503	050508	970527	050557	971631	050563
	963935	090054	968638	050486	970528	050558	971632	050563
	964041	090077	968639	050487	970547	971822	971635	050397
	964066	090107	968762	968793	970549	900588	971638	050565
	964085	090063	968833	050449	970567	050616	971781	050559
	964154	090102	968834	090056	970597	050557	971782	050560
	964358	900541	968862	050597	970598	050557	971796	050507
	964360	090034	968863	050596	970599	050557	971837	090046
	964363	050509	968868	050619	970601	050558	971838	090044
	964390	090037	968957	090057	970602	050558	971910	050524
	964395		968964	090058	970603	050558	971974	050526
	964557	090073	968969	090067	970719	090036	971993	090049
	965278	050360	969199	050361	970771	090068	971493	090041
	965279	050359	969219	050603	970815	050576	971494	090042
	965294	090033	969235	050542	970817	050358	990592	050540
	965300	050362	969244	050543	970863	972549	990598	050539
	965301	050363	969252	090071	970873	970872	990598	050539
	965322	090009	969295	971010	970909	050500		
	965325	050273	969297	090075	970911	050559		
	965326	050274	969300	661481	970912	050559		
	965335	090017	969369	050477	970914	050560		
	965506	050505	969467	090079	970915	050560		
	965676	090021	969855	050566	971050	090066		
	965916	090092	969864	050564	971052	050562		
	965917	090091	969506	050566	971053	050562		
	965996	050331	111939	050194	971055	050563		
	106767	050325	969520	050529	960577	050279		
	966165	050370	969582	090076	971056	050563		

A library of common wiring diagrams are available at no-charge for use in single and double door applications utilizing various configurations of Allegion door hardware products. These diagrams and much more can be accessed through our Knowledge Center tool at <http://kc.allegion.com/>, simply click on the link Common wiring diagrams.

CUSTOM WIRING DIAGRAMS

When common wiring diagrams do not meet the needs of the job requirements, Allegion offers a service to purchase custom wiring diagrams. All custom wiring diagrams include a point-to-point drawing, a riser diagram, and a detailed theory of operation. Custom wiring diagrams fall into two categories; Standard and Complex.

- **Standard drawings:** All Allegion products with a single opening and a basic theory of operation. These drawings will be quoted a NET \$250 for each drawing
- **Complex drawings:** Generic contacts, 3rd party components, complex relay logic, timer circuit logic, any other additional advanced logic. Drawings that fall under this type will receive a NET quote depending on the time required to complete the drawings at an hourly rate of \$200/hour with a \$250 minimum NET

HOW TO REQUEST A QUOTE FOR A CUSTOM WIRING DIAGRAM

- Custom wiring diagrams can only be ordered by and shipped to current Allegion Channel Partners
- Wiring Diagram Request Forms can be obtained by:
 - Sending an email request to Wiring.Diagram.Request@allegion.com
 - Using the online Distributor Portal under; My Support / Orders & Invoicing
 - Using the form located on page 198
- Once completed, email the completed request form to Wiring.Diagram.Request@allegion.com for processing
- Be sure and include the following information to prevent delays to the request:
 - All supporting documentation for non-Allegion products
 - Hardware list with complete part numbers
 - Detailed Theory of operation for all openings
- Upon receipt the custom wiring coordinator will review and clarify the request as needed
- Once all clarifications are resolved a QUOTE#, NET pricing, and lead time will be assigned and communicated to the requestor within 1 business day
- QUOTE# is valid for 90 days
- A purchase order with the QUOTE# must be received for the wiring diagrams to be produced
 - Send the completed PO to Wiring.Diagram.Request@allegion.com
- Lead time is generally 2-3 weeks from time PO is received, more complex requests will have longer lead times
- Changes to the original request after a quote approval may incur additional charges and affect lead time
- Completed custom wiring diagrams will be emailed to the requestor

Wiring Diagram Request Form

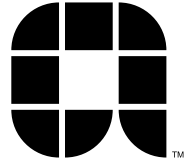

ALLEGION™

Must be a Schlage Electronics, LCN, or Von Duprin Dealer

.....

Date ___/___/___ Project Name _____

Dealer/Distributor _____

Account # _____ Dealer Contact Name _____

Phone _____ - _____ - _____

.....

Provide a Primary Technical Contact _____ Phone _____ - _____ - _____

.....

Provide/Attach the Following

- All supporting documentation for all non-Allegion products.
 - Included hardware list with complete part numbers.
 - Detailed Theory of Operation for all openings.

Additional information that helps expedite the project:

Door Number; Door Size; Door Material;
 Fire Rated Opening; Single/Pair; Double Egress; Interior/Exterior;
 Interlocked Opening; Basic Floor Plan/Traffic Flow

.....

E-mail completed form and supporting documentation to

Wiring.Diagram.Request@allegion.com

Phone: 877-671-7011



22 SERIES

33A/35A SERIES

55 SERIES

88 SERIES

98/99 SERIES

XP98/XP99 SERIES

94/95 SERIES

GUARD-X SERIES

ACCESSORIES / PARTS

ELECTRICAL / PARTS

About Allegion

Allegion (NYSE: ALLE) is a global pioneer in seamless access, with leading brands like CISA®, Interflex®, LCN®, Schlage®, SimonsVoss® and Von Duprin®. Focusing on security around the door and adjacent areas, Allegion secures people and assets with a range of solutions for homes, businesses, schools and institutions. Allegion had \$2.9 billion in revenue in 2019 and sells products in almost 130 countries.

For more, visit www.allegion.com

KRYPTONITE ■ LCN ■  ■ STEELCRAFT ■ VON DUPRIN