



# Adams Rite Architectural Hardware

## 2019–2020 Product Pricelist

US & Canada Effective date December 1, 2019

Experience a safer  
and more open world

# Adams Rite Architectural Hardware

2019 – 2020  
Product Pricelist

---

[adamsrite.com](http://adamsrite.com)



Experience a safer  
and more open world

# 2019–2020 Price List Adams Rite Architectural Hardware

## DEADLOCKS

RT1050 RITE Touch® Digital Glass Door Lock	2
1830 Bottom Rail Deadlock Swingbolt	2
MS1837 Series MS® Two-Point Deadlock	2
MS1847 Series MS® Deadlock/Deadlatch	3
MS1850S, MS1850S-X5X Series MS® Deadlock	3
1850S-X2X Series Short Throw Deadlock	4
MS1850SN, MS1850SN-45X Series MS® Deadlock (ANSI Size)	4
MS1861 Series MS® Bottom Rail Deadlock	4
1875 Two-Point Deadlock	5
MS+1890 Series MS® Deadlock/Deadlatch	5
MS1950, MS1950-X5X Series MS® Deadlock	5
2190, 2290 Dual Force® Interconnected Deadbolt/Deadlatch for Aluminum Stile Doors (2190); for Wood or Hollow Metal (2290)	6
2331 Heavy Duty Deadbolt	7
4070 Series Short Throw Deadbolt (Projection Style)	7
5017 Deadlock/Deadlatch for Wood Doors	7
5500 Deadlock for Sliding Wood Doors	7
4189, 4190 Flush Locksets (Including Deadlock) moved to Flushlock section	
4430, 4431 Flush Locksets (Including Deadlock) moved to Flushlock section	

## DEADLATCHES

4300 Steel Hawk® Electrified Deadlatch	8
4300 RITE Pack®	8
4510 Standard Duty Deadlatch	9
4530 Standard Duty Deadlatch	9
4781 Two-Point Deadlatch with Paddle	10
4900 Heavy Duty Deadlatch	10
4920AN Heavy Duty Deadlatch (ANSI Size)	10

## FLUSHLOCKS

1870 Cylinder-Operated Flushbolt	11
1870HM Cylinder-Operated Flushbolt	11
1877 Cylinder-Operated Flushbolt	11
MS1880, MS1881 Two-Point Flushlocks	12
MS2180 Auto-Release Two-Point Flushbolt	12
4189, 4190 Flush Locksets (Including Deadlock)	13
4430, 4431 Flush Locksets (Including Deadlock)	13

B1921, B1923 Reinforcing Pivots moved to Cylinders and Accessories section

## EXIT DEVICES

8099 Dummy Pushbar	14
8100   3100 Surface Vertical Rod Exit Device	14
8200 Narrow Stile Surface Vertical Rod Exit Device	15
8300   3300 Mortise Exit Device	15
8400 Narrow Stile Mortise Exit Device	16
8500   3600 Metal Door Concealed Vertical Rod Exit Device	17
8600 Narrow Stile Concealed Vertical Rod Exit Device	17
8700   3700 Rim Exit Device	18
8800 Narrow Stile Rim Exit Device	18
8900   3900 Wood Door Concealed Vertical Rod Exit Device	19
Accessories for 3000/8000 Series Exit Devices	19
Kitted Options for 3000/8000 Series Exit Devices	19
Modification Options for 3000/8000 Series Exit Devices	19

## EX Series

EX76 Concealed Vertical Rod Exit Device	20
EX80 Dummy Push Bar	20
EX88 Interlocking Rim Exit Device	20
EX89 Pullman Rim Exit Device	20
Accessories for EX Series Exit Devices	20

## ELECTRIC STRIKES

7100, 7101 Electric Strikes	21
7110, 7111 Electric Strikes	21
7130, 7131 Electric Strikes	22
7140 Electric Strike	22
7160 Electric Strike	22
7170 Electric Strike	23
7100 Series Electric Strikes Components	23
7240 Fire-Rated Electric Strike	24
7270 Fire-Rated Electric Strike	24
7400, 7401 Ultraline® Electric Strikes	24
7410, 7411 Ultraline® Electric Strikes	25
7430, 7431 Ultraline® Electric Strikes	25
7440 Ultraline® Electric Strikes	25
74R1 Ultraline® Electric Strike	26
74R2 Ultraline® Electric Strike	26
7400 Series Electric Strikes Components	27
7800 Series Electric Strike	28
7800 Series Electric Strikes Components	28

## TRIM

1000 Series Turns	29
3000 Fixed Pull	29
3080 Series Entry Trim	30
3090 eForce® Keyless Entry	31
A100-3090H Keyless Entry and Aperio® Hub Pre-Paired Kit	31
4060 Turn	32
4550 MS® Deadlock Lever	32
4560, 4565 Series Deadlatch Handles	33
4568, 4569 Eurostyle Deadlatch Handles	34
4590 Deadlatch Paddle	35
4591 Deadlatch Paddle	36
4600 Heavy Duty Designer Deadlatch Handles	37

## CYLINDERS & ACCESSORIES

4024, 4025, 4026 Cylinder Pulls	38
4036 Mortise Cylinder	38
MS4043 Cylinder Guard	39
4066 Thumbturn	39
4580 Cam Disc	39
4581 Universal Cam Disc	39
8650 Cylinder Escutcheon Kit	40
8736 Rim Cylinder	40
4014 Two-Point Conversion Kit	40
4015 Threshold Bolt	40
4016 Header Bolt	40
4085 Header Bolt (Pairs of Doors Only)	41
4089 Exit Indicator	41
4104 Mounting Bridges	41
91-0965 Universal Mounting Tab Kits for Installing MS® Locks & Latches	41
B1921, B1923 Reinforcing Pivots	42

## Strikes

2190 Dual Force® Interconnected Deadbolt/Deadlatch Strikes	42
2290 Dual Force® Interconnected Deadbolt/Deadlatch Strikes	42
4000 Series MS® Deadlock Strikes	42
4800, MS 4804 Series Strikes	43
4901, 4902 Deadlatch Strikes	43
4304 Deadlatch Strike	43

## CYLINDERS & ACCESSORIES CONT.

<b>Thick Door Kits</b>	
2190, 2290 Dual Force® Interconnected Deadbolt/Deadlatch Thick Door Kit	44
4568, 4569 Eurostyle Deadlatch Handles Thick Door Kits	44

## Faceplates

MS1850S Deadlocks Faceplates	44
MS1850S, MS1950 Deadlock (Standard Bolt) Faceplates	44
MS1850S, MS1950 Deadlock (Hookbolt and Short Bolt) Faceplates	45
MS1850SN Deadlock (Standard Bolt) Faceplates	45
MS1850SN Deadlock (Hookbolt) Faceplates	45
1870 Flushbolt Faceplates	45
MS+1890 Deadlock Faceplates	45
2190 Dual Force® Interconnected Deadbolt/Deadlatch Faceplates	46
2331 Heavy Duty Deadbolt Faceplates	46
3300 Fire-Rated Mortise Exit Device Faceplates	46
4070 Short Throw Deadbolt Faceplates	46
4500 Standard Duty Deadlatch Faceplates	46
4530 Standard Duty Deadlatch Faceplates	46
4900 Heavy Duty Deadlatch Faceplates	46
4900 Heavy Duty Deadlatch Special Faceplates	47
4920, 8300 Faceplates	47
7100, 7160 Electric Strikes Faceplates	47
7101 Electric Strike Faceplates	47
7110 Electric Strike Faceplates	47
7111 Electric Strike Faceplates	47
7130 Electric Strike Faceplates	47
7131 Electric Strike Faceplates	47
7140, 7170 Electric Strike Faceplates	47

## POWER

PS-1 Power Supply	48
PS-LR Power Supply	48
PS-SE Power Supply	48
4612 Power Transfer Device	48
4603, 4605, 4606 Accessories for Power	48

## DEMO MOUNTS

### Deadlocks & Deadlatches

RT1050 RITE Touch® Digital Glass Door Lock	49
2190 Dual Force® Interconnected Deadbolt/Deadlatch	49
4300 Steel Hawk® Electrified Deadlatch (eLatch)	49

### Exit Devices

8400 Narrow Stile Mortise Exit Device	49
---------------------------------------	----

### Electric Strikes

7400 Ultraline® Electric Strikes	49
----------------------------------	----

### Trim

A100-3090H Keyless Entry and Aperio® Hub Wholesale Kit	50
4600 Heavy Duty Designer Deadlatch Handles	50

## GENERAL INFORMATION

Adams Rite Limited Warranty/Terms and Conditions	51
Canadian Terms & Conditions	51

# DEADLOCKS

## RT1050 RITE Touch® Digital Glass Door Lock

MODELS	DESCRIPTION	PRICE
RT1050D	Digital glass door lock with thumbturn, for single doors, or pairs of doors with one inactive leaf	\$668
RT1050L	Digital glass door lock with lever, for single doors, or pairs of doors with one inactive leaf	\$668
RT-5C-1050	Extra cards (package of 5 cards)	\$63

**How to Order** Specify quantity and the following information. Order related products separately

PRODUCT	MODEL	TRIM
RT	1050	D
	1050 For glass doors	D Thumbturn
		L Accessibility lever



## 1830 Bottom Rail Deadlock (Swing Bolt)

MODEL	DESCRIPTION	313, 628
1830	Deadlock with 31/32" or 1-1/8" cylinder height	\$143

**How to Order** Specify quantity and the following information. Order related products separately

PRODUCT NO.	DASH NO. (SPECIFY FOR CYLINDER HEIGHT AND LOCK DEPTH)	FINISH
1830	-02	-628
	02 Cylinder Height 31/32" Dim. "A" 1-5/8"	628 Clear Anodized
	03 Cylinder Height 1-1/8" Dim. "A" 1-25/32"	313 Dark Bronze Anodized



## MS1837 Series MS® Two-Point Deadlock

MODELS	DESCRIPTION & FINISHES	313, 335, 628	605, 626
MS1837	Deadlock includes 4001-011 strike, 36" cylinder height	\$252	\$340
MS1837	Deadlock includes 4001-011 strike, contact factory for cylinder height other than 36" up to maximum cylinder height 65"	\$309	\$397

*If cylinder height other than 36" is required, specify exact height from bottom of door to cylinder center. Maximum cylinder height 65".*

**How to Order** Specify quantity and the following information. Order related products separately

PRODUCT NO.	FINISH
MS1837	-313
	313 Dark Bronze Anodized
	335 Black Anodized
	605 Bright Brass
	626 Satin Chrome
	628 Clear Anodized

*If cylinder height other than 36" is required, specify exact height from bottom of door to cylinder center. Maximum cylinder height 65".*



## MS1847 Series MS® Deadlock/Deadlatch

MODEL	DESCRIPTION & FINISH	630
MS1847	Deadlock/deadlatch, stainless steel	\$63

**How to Order** Specify quantity and the following information. Order related products separately

PRODUCT NO.	FACE SHAPE, HUB ANGLE, LOCK OR LATCH	FINISH
MS1847	-02	-630
	(See Configuration table below)	630 Satin Stainless



## MS1850S, MS1850S-X5X Series MS® Deadlock

MODELS	DESCRIPTION & BACKSETS	7/8"	31/32", 1-1/8", OR 1-1/2"
MS1850S	Flat faceplate, 313, 335, or 628 finish, without strike plate	\$84	\$72
MS1851S	Radius faceplate, 313, 335, or 628 finish, without strike plate	\$84	\$72
MS1851SW	Radius faceplate with weatherstrip, 313, 335, or 628 finish, without strike plate	\$90	\$77
MS1852S	Bevel faceplate, 313, 335, or 628 finish, without strike plate.	\$84	\$72
<b>SPECIAL MODEL</b>			
MS1853S-XXX-IB	Without faceplate, without strike plate	\$76	\$63

*Schoolhouse function for above deadlocks add \$37. Please contact factory for more information.*

**How to Order** Specify quantity and the following information. Order related products separately

PRODUCT NO.	FACEPLATE	BACKSET	BOLT SHAPE	HANDING	FINISH
MS185	0S	-2	1	0	-628
	0S Flat	1 7/8"	1 Straight bolt	0 Non-Handed*	313 Dark Bronze Anodized
	1S Radius	2 31/32"	5 Hookbolt	5 LH or RHR	335 Black Anodized
	1SW Radius with weatherstrip	3 1-1/8"		6 RH or LHR	628 Clear Anodized
	2S Bevel	4 1-1/2"			
	3S Without faceplate, without strike plate				

*\*Any flat or radius faceplate, except Schoolhouse. Select handing for bevel faceplate only.*



## 1850S-X2X Series Short Throw Deadlock

MODELS	DESCRIPTION & FINISHES	313, 335, 628
1850S	Flat faceplate, 31/32", 1-1/8", or 1-1/2" backset, without strike plate	\$72
1851S	Radius faceplate, 313, 335, or 628 finish, without strike plate	\$72
1852S	Bevel faceplate, any handing, 313, 335, or 628 finish, without strike plate	\$72
SPECIAL MODEL	DESCRIPTION	PRICE
1853S-X20-IB	WITHOUT faceplate, without strike plate	\$63



**How to Order** Specify quantity and the following information. Order related products separately

PRODUCT NO.	FACEPLATE	BACKSET	BOLT SHAPE	HANDING	FINISH
185	OS	-2	2	0	-628
	0S Flat	2 31/32"	2 Short Throw	0 Non-Handed*	313 Dark Bronze Anodized
	1S Radius	3 1-1/8"		5 LH or RHR	628 Clear Anodized
	2S Bevel	4 1-1/2"		6 RH or LHR	
	3S Without faceplate, without strike plate				

\*Any flat or radius faceplate, except Schoolhouse. Select handing for bevel faceplate only.

## MS1850SN, MS1850SN-45X Series MS® Deadlock (ANSI Size)

MODELS	DESCRIPTION & FINISH	313, 335, 628
MS1850SN	Flat faceplate, 1-1/2" backset, without strike plate	\$102
MS1851SN	Radius faceplate, 1-1/2" backset, without strike plate	\$102
MS1852SN	Bevel faceplate, any handing, 1-1/2" backset, without strike plate	\$102



**How to Order** Specify quantity and the following information. Order related products separately

PRODUCT NO.	FACEPLATE	ANSI SIZE	BOLT SHAPE	HANDING	FINISH
MS185	0	SN	-41	0	-628
	0 Flat		41 Straight bolt	0 Non-Handed*	313 Dark Bronze Anodized
	1 Radius		45 Hookbolt	5 LH or RHR	335 Black Anodized
	2 Bevel			6 RH or LHR	628 Clear Anodized

\*Any flat or radius faceplate, except Schoolhouse. Select handing for bevel faceplate only.

## MS1861 Series MS® Bottom Rail Deadlock

MODELS	DESCRIPTION & FINISH	603
MS1861-01	One-point deadlock, vertical bolt operation only	\$149
MS1861-02	Two-point deadlock, horizontal and vertical operation	\$185



**How to Order** Specify quantity and the following information. Order related products separately

PRODUCT NO.	BOLT OPERATION	FINISH	PACKAGING
MS1861	-01	-603	-IB
	01 Vertical Bolt Only	603 Zinc plated steel	IB Individually Boxed
	02 Vertical and Horizontal Bolts		

If tube spacers are required please specify quantity and length.

## 1875 Two Point Deadlock

MODEL	DESCRIPTION & FINISH	603
1875	Two-point deadlock for roll-up doors	\$185



**How to Order** Specify quantity and the following information. Order related products separately

PRODUCT NO.	PACKAGING
1875	-IB
	IB Individually Boxed

## MS+1890 Series MS® Deadlock/Deadlatch

MODELS & FINISHES	313, 335, 628
MS+1890 Flat faceplate, 31/32", 1-1/8", or 1-1/2" backset	\$253
MS+1891 Radius faceplate, 31/32", 1-1/8", or 1-1/2" backset	\$253
MS+1891W Radius faceplate with weatherstrip, 31/32", 1-1/8", or 1-1/2" backset	\$264
MS+1892 Bevel faceplate, any handing, 31/32", 1-1/8", or 1-1/2" backset	\$253
SPECIAL MODELS	PRICE
MS+1890, MS+1891, MS+1892 Flat, radius, or bevel faceplate, complete with flat / center hung 4" or 4-1/2" strike plate	\$266
MS+1893-XX-IB Without faceplate, without strike plate	\$192



**How to Order** Specify quantity and the following information. Order related products separately

PRODUCT NO.	FACEPLATE	BACKSET	STRIKE SHAPE/LIP LENGTH	HANDING	FINISH
MS+189	1	-3	02	6	-628
	0 Flat	2 31/32"	01 Flat/Standard Jamb	5 LH or RHR	313 Dark Bronze Anodized
	1 Radius	3 1-1/8"	02 Radius/Standard Stile	6 RH or LHR	
	1W Radius with weatherstrip	4 1-1/2"	17 Flat/Center Hung 4" Jamb		335 Black Anodized
	2 Bevel		21 Flat/Center Hung 4-1/2" Jamb		628 Clear Anodized
	3 Without faceplate, without strike plate				

*For door thickness other than 1-3/4" please contact factory.*

## MS1950, MS1950-X5X Series MS® Deadlock

MODELS	313, 335, 628
MS1950 Flat faceplate, 31/32", 1-1/8", or 1-1/2" backset, without strike plate	\$132
MS1951 Radius faceplate, 31/32", 1-1/8", or 1-1/2" backset, without strike plate	\$132
MS1951W Radius faceplate with weatherstrip, 31/32", 1-1/8", or 1-1/2" backset, without strike plate	\$137
MS1952 Bevel faceplate, any handing, 31/32", 1-1/8", or 1-1/2" backset, without strike plate	\$132
SPECIAL MODEL	PRICE
MS1953S-XXX-IB Without faceplate, without strike plate	\$124

*Schoolhouse function for above deadlocks add \$37. Please contact factory for more information.*

**How to Order** Specify quantity and the following information. Order related products separately

PRODUCT NO.	FACEPLATE	BACKSET	BOLT SHAPE	HANDING	FINISH
MS195	0	-2	1	0	-628
	0 Flat	2 31/32"	1 Straight bolt	0 Non-Handed*	313 Dark Bronze Anodized
	1 Radius	3 1-1/8"	5 Hookbolt	5 LH or RHR	335 Black Anodized
	1W Radius with weatherstrip	4 1-1/2"		6 RH or LHR	628 Clear Anodized
	2 Bevel				
	3 Without faceplate, without strike plate				

*\*Any flat or radius faceplate, except Schoolhouse.*



## 2190, 2290 Dual Force®

Interconnected Deadbolt/Deadlatch for Aluminum Doors (2190); for Wood or Hollow Metal Doors (2290)

		STANDARD TRIM SET		ELECTRIFIED TRIM SET		LOW PROFILE TRIM	
MODELS & TRIM SETS		10B, US4, US32D	US3, US32	10B, US4, US32D	US3, US32	10B, US4, US32D	US3, US32
STANDARD LEVER	2190, 2290 Deadbolt/Deadlatch with standard lever (01, 02, 03), complete with strike plate	\$646	\$730	\$815	\$899	\$571	\$655
	2190 Deadbolt/Deadlatch with standard lever (01, 02, 03), complete with flat/center hung 4" or 4-1/2" strike plate	\$662	\$746	\$831	\$915	\$587	\$671
	2190, 2290 Deadbolt/Deadlatch with standard lever (01, 02, 03), without strike plate	\$620	\$704	\$789	\$873	\$545	\$629
DESIGNER LEVER	2190, 2290 Deadbolt/Deadlatch with designer lever series (MD through MW), complete with strike plate	\$693	\$777	\$862	\$946	\$618	\$702
	2190 Deadbolt/Deadlatch with with designer lever series (MD through MW), complete with flat/center hung 4" or 4-1/2" strike plate	\$709	\$793	\$878	\$962	\$634	\$718
	2190, 2290 Deadbolt/Deadlatch with designer lever series (MD through MW), without strike plate	\$667	\$751	\$836	\$920	\$592	\$676
MODELS & FINISHES					313, 335, 628		N/A
2190, 2290 Boxed Lock Less lever trim, with adjustable faceplate and choice of standard or radius strike					\$315		
EK-2190 Electrification Kit for 2190, 2290; 12/24 VAC/VDC (not compatible with low profile trim)							\$179



### How to Order

Specify quantity and the following information. Order related products separately

PRODUCT NO.	BACKSET	STRIKE	FACEPLATE FINISH	TRIM	HANDLE DESIGNATION	TRIM AND HANDLE FINISH			
2190	-3	1	1	-1	01	32D			
	3 1-1/8"	0 None	1 Clear Anodized 628	0 None	00 No Handle	03 Bright Brass (US3)			
	4 1-1/2"	1 Standard Flat	2 Dark Bronze Anodized 313	1 With Trim Set	STANDARD SERIES:	04 Satin Brass (US4)			
					2 Radius Strike	3 Black Anodized 335	2 With Electrified Trim Set	01 Curve	10B Dark Bronze
					3 Flat/Center Hung 4"	3 Low Profile Trim	3 Low Profile Trim	02 Round	32 Bright Stainless (US32)
					4 Flat/Center Hung 4-1/2"			03 Square	32D Satin Stainless (US32D)
	DESIGNER SERIES:								
					MD MG MJ MV (Handed)				
					ME MI MN (Handed) MW				

### How to Order

Specify quantity and the following information. Order related products separately

PRODUCT NO.	BACKSET	STRIKE	FACEPLATE FINISH	TRIM	HANDLE DESIGNATION	TRIM AND HANDLE FINISH		
2290	-3	1	1	-1	01	32D		
	3 1-1/8"	0 None	0 US to match trim finish	0 None	00 No Handle	03 Bright Brass (US3)		
	4 1-1/2"	1 Standard Flat	1 Clear Anodized 628	1 With Trim Set	STANDARD SERIES:	04 Satin Brass (US4)		
					2 Dark Bronze Anodized 313	2 With Electrified Trim Set	01 Curve	10B Dark Bronze
					3 Low Profile Trim	3 Low Profile Trim	02 Round	32 Bright Stainless (US32)
							03 Square	32D Satin Stainless (US32D)
	DESIGNER SERIES:							
					MD MG MJ MV (Handed)			
					ME MI MN (Handed) MW			

Designed for outswing doors only.



## 2331 Heavy Duty Deadbolt

MODEL & FINISHES	121, 626	605, 625
2331 Deadbolt, 1-3/4" backset, complete with strike	\$315	\$346

**How to Order** Specify quantity and the following information. Order related products separately

PRODUCT NO.	FINISH
2331	-626
	121 To Match 313 Dark Bronze Anodized
	605 Bright Brass
	625 Bright Chrome
	626 Satin Chrome



## 4070 Series Short Throw Deadbolt (Projection Style)

MODELS & FINISHES	313, 335, 628
4070 Flat faceplate, 7/8", 31/32", or 1-1/8" backset, without strike plate	\$174
4071 Radius faceplate, 7/8", 31/32", or 1-1/8" backset, without strike plate	\$174
4072 Bevel faceplate, any handing, 7/8", 31/32", or 1-1/8" backset, without strike plate	\$174
SPECIAL MODEL	PRICE
4073-XX-IB Without faceplate, without strike plate	\$164

**How to Order** Specify quantity and the following information. Order related products separately

PRODUCT NO.	FACEPLATE	BACKSET	HANDING	FINISH
407	2	-2	6	-628
	0 Flat	1 7/8"	0 Non-Handed*	313 Dark Bronze Anodized
	1 Radius	2 31/32"	5 LH or RHR	335 Black Anodized
	2 Bevel	3 1-1/8"	6 RH or LHR	628 Clear Anodized
	3 Without faceplate, without strike plate			

\*Any flat or radius faceplate. Select handing for bevel faceplate only.



## 5017 Deadlock/Deadlatch for Wood Doors

MODELS & FINISH	630
5017-00 Standard stainless steel deadlock	\$64
5017-02 Self-latching deadlock/deadlatch	\$64

**How to Order** Specify quantity and the following information. Order related products separately

PRODUCT NO.	LATCH CONFIGURATION
5017	-00
	00 Standard
	02 Self Latching



## 5500 Deadlock for Sliding Wood Doors

MODELS	119, 626
5500-20 Lockset, strike, and trim included for 1-1/4", sliding wood doors	\$137

**How to Order** Specify quantity and the following information. Order related products separately

PRODUCT NO.	DOOR THICKNESS	FINISH
5500	-20	-626
	20 1-1/4" Thick	626 Satin Chrome
		119 to Match 335 Black Anodized



US [adamsrite.com](http://adamsrite.com) | 800.872.3267 | [customerservice.adamsrite@assaabloy.com](mailto:customerservice.adamsrite@assaabloy.com)  
 CANADA [assaabloydss.ca](http://assaabloydss.ca) | 800.461.3007 | [sales.dss.ca@assaabloy.com](mailto:sales.dss.ca@assaabloy.com)

Patent pending and/or patent [www.assaabloydss.com/patents](http://www.assaabloydss.com/patents). Copyright © 2019, Hanchett Entry Systems, Inc., an ASSA ABLOY Group company. All rights reserved. Reproduction in whole or in part without the express written permission of Hanchett Entry Systems, Inc. is prohibited.

# DEADLATCHES

## 4300 Steel Hawk® Electrified Deadlatch

MODELS & FINISHES		313, 335, 628
4300	Electrified deadlatch 31/32", 1-1/8", or 1-1/2" backset	\$453
4300M	Monitored option, 31/32", 1-1/8", or 1-1/2" backset	\$518
SPECIAL MODELS		
4300	Electrified deadlatch complete with flat / center hung 4" or 4-1/2" strike plate	\$474
4300M	Electrified deadlatch with monitored option, complete with flat / center hung 4" or 4-1/2" strike plate	\$539



**How to Order** Specify quantity and the following information. Order related products separately

PRODUCT NO.	BACKSET	MONITORING	STRIKE	STRIKE SHAPE/LIP LENGTH	FACEPLATE FINISH
4300	-3	M	-2	01	-628
	2 31/32"	0 None	1 Surface Mount (4304)	01 Flat/Standard Jamb	313 Dark Bronze Anodized
	3 1-1/8"	M Monitored	2 Mortised (4901) 4-5/8"	02 Radius/Standard Stiles**	335 Black Anodized
	4 1-1/2"			17 Flat/Center Hung 4" Jamb**	628 Clear Anodized
				21 Flat/Center Hung 4-1/2" Jamb**	

\*\* See ACCESSORIES for available 4901 strike options.

## 4300 RITE Pack®

MODELS		313, 628
4300-20	31/32" backset, flat and radius, 313 and 628 finish faceplates, surface mount or mortise strike	\$464
4300-30	1-1/8" backset, flat and radius, 313 and 628 finish faceplates, surface mount or mortise strike	\$464

**How to Order** Specify quantity and the following information. Order related products separately

PRODUCT NO.	BACKSET	MONITORING	STRIKE	RITE PACK
4300	-3	0	-1	RP
	2 31/32"	0 None	1 Surface Mount (4304)	
	3 1-1/8"		2 Mortised (4901) 4-5/8"	



## 4510 Standard Duty Deadlatch

MODELS & FINISHES	313, 335, 628
4510 Flat faceplate, 7/8", 31/32", 1-1/8", or 1-1/2" backset, complete with strike plate	\$88
4511 Radius faceplate, 7/8", 31/32", 1-1/8", or 1-1/2" backset, complete with strike plate	\$88
4511W Radius faceplate with weatherstrip, 7/8", 31/32", 1-1/8", or 1-1/2" backset, complete with strike plate	\$93
4512 Bevel faceplate, 7/8", 31/32", 1-1/8", or 1-1/2" backset, complete with strike plate	\$88
SPECIAL MODELS	
4510, 4511, 4512 Flat, radius or bevel faceplate complete with flat / center hung 4" or 4-1/2" strike plate	\$109
4511W Radius faceplate with weatherstrip complete with flat / center hung 4" or 4-1/2" strike plate	\$114
4510, 4511, 4512 With faceplate, without strike plate	\$71
4511W Radius faceplate with weatherstrip, without strike plate	\$76
4513-XX-IB Without faceplate, without strike plate	\$63



**How to Order** Specify quantity and the following information. Order related products separately

PRODUCT NO.	FACEPLATE	BACKSET	HANDING	STRIKE SIZE	STRIKE SHAPE/LIP LENGTH	FACEPLATE FINISH
451	1	-3	6	-2	01	-628
	0 Flat	1 7/8"	5 LH or RHR	1 Mortised (4901) 4-5/8"	01 Flat/Standard Jamb	313 Dark Bronze Anodized
	1 Radius	2 31/32"	6 RH or LHR	2 Mortised (4902) 2-5/8"	02 Radius/Standard Stiles	335 Black Anodized
	1W Radius with weatherstrip	3 1-1/8"			17 Flat/Center Hung 4" Jamb	628 Clear Anodized
	2 Bevel	4 1-1/2"			21 Flat/Center Hung 4-1/2" Jamb	
	3 Without faceplate, without strike plate					

## 4530 Standard Duty Deadlatch

MODELS & FINISHES	313, 335, 628
4530 Flat faceplate, 7/8", 31/32", or 1-1/8" backset, complete with strike plate	\$108
4531 Radius faceplate, 7/8", 31/32", or 1-1/8" backset, complete with strike plate	\$108
4532 Bevel faceplate, 7/8", 31/32", or 1-1/8" backset, complete with strike plate	\$108
SPECIAL MODELS	
4530, 4531, 4532 Flat, radius or bevel faceplate complete with flat / center hung 4" or 4-1/2" strike plate	\$129
4530, 4531, 4532 With faceplate without strike plate	\$90
4533-XX-IB Without faceplate, without strike plate	\$82



**How to Order** Specify quantity and the following information. Order related products separately

PRODUCT NO.	FACEPLATE	BACKSET	HANDING	STRIKE SIZE	STRIKE SHAPE/LIP LENGTH	FACEPLATE FINISH
453	1	-3	6	-1	01	-628
	0 Flat	1 7/8"	5 LH or RHR	1 Mortised (4901) 4-5/8"	01 Flat/Standard Jamb	313 Dark Bronze Anodized
	1 Radius	2 31/32"	6 RH or LHR	2 Mortised (4902) 2-5/8"	02 Radius/Standard Stiles	335 Black Anodized
	2 Bevel	3 1-1/8"			17 Flat/Center Hung 4" Jamb	628 Clear Anodized
	3 Without faceplate, without strike plate				21 Flat/Center Hung 4-1/2" Jamb	

## 4781 Two-Point Deadlatch with Paddle

MODEL & FINISHES	313, 335, 628	US26D
4781 Paddle includes dogging feature	\$342	\$458
4781T Paddle with top rod only (less bottom rod)	\$310	\$435

**How to Order** Specify quantity and the following information. Order related products separately

PRODUCT NO.	OPERATION	PADDLE FINISH
4781	T	-021
	T Top rod only	021 Push to LEFT
	- Standard rod	041 Push to RIGHT
		313 Dark Bronze Anodized
		335 Black Anodized
		628 Clear Anodized
		US26D Satin Chrome



## 4900 Heavy Duty Deadlatch

MODELS & FINISHES	313, 335, 628
4900 Flat and radius faceplates, 31/32", 1-1/8", or 1-1/2" backset, complete with strike plate	\$121
4911W Radius with weatherseal faceplate, 31/32", 1-1/8", or 1-1/2" backset, complete with strike plate	\$127
SPECIAL MODELS	
4900 Flat and radius faceplates complete with flat / center hung 4" or 4-1/2" strike plate	\$142
4911W Radius with weatherstrip faceplate complete with flat / center hung 4" or 4-1/2" strike plate	\$148
4900 Flat and radius faceplate, without strike plate	\$103
4911W Radius with weatherstrip faceplate, without strike plate	\$109
4913-XX-IB Without faceplate, without strike plate	\$95



**How to Order** Specify quantity and the following information. Order related products separately

PRODUCT NO.	FACEPLATE	BACKSET	HANDING	STRIKE SIZE	STRIKE SHAPE/LIP LENGTH	FACEPLATE FINISH
49	00	-3	5	-2	01	-628
	00 Standard	2 31/32"	5 LH or RHR	1 Mortised (4901) 4-5/8"	01 Flat/Standard Jamb	313 Dark Bronze Anodized
	11W Radius with Weatherstrip	3 1-1/8"	6 RH or LHR	2 Mortised (4902) 2-5/8"	02 Radius/Standard Stile	335 Black Anodized
	13 Without faceplate, without strike plate	4 1-1/2"			17 Flat/Center Hung 4" Jamb	628 Clear Anodized
					21 Flat/Center Hung 4-1/2" Jamb	

## 4920AN Heavy Duty Deadlatch (ANSI Size)

MODELS & FINISHES	313, 335, 628
4920AN Flat faceplate, 1-1/2" or 2-3/4" backset, complete with 4506 strike plate	\$148
SPECIAL MODELS	
4920AN Flat faceplate, without strike plate	\$109
4923AN-XX-IB Without faceplate, without strike plate	\$86

**How to Order** Specify quantity and the following information. Order related products separately

PRODUCT NO.	FACEPLATE	BACKSET	HANDING	STRIKE	FACEPLATE FINISH
492	0AN	4	6	-602	-313
	0AN Flat	4 1-1/2"	5 LH or RHR	000 Less Strike	313 Dark Bronze Anodized
	3AN Without faceplate, without strike plate	5 2-3/4"	6 RH or LHR	602 4506 Strike	335 Black Anodized
					628 Clear Anodized



# FLUSHLOCKS

## 1870 Cylinder-Operated Flushbolt

MODELS & CYLINDER HEIGHT	STANDARD 12" CYLINDER HEIGHT	CYLINDER HEIGHT OVER 12" (SPECIFY)
1870 Flat faceplate, 313, 335, or 628 finish	\$125	\$179
1871 Radius faceplate, 313, 335, or 628 finish	\$125	\$179
1871W Radius faceplate with weatherstrip, 313, 335, or 628 finish	\$130	\$184
1872 Bevel faceplate, 313, 335, or 628 finish	\$125	\$179

For cylinder height greater than 12" up to maximum cylinder height 65" please contact factory.



### How to Order

Specify quantity and the following information. Order related products separately

PRODUCT NO.	FACEPLATE SHAPE	BACKSET	HANDING*	FINISH
187	0	-2	0	-628
	0 Flat	2 31/32"	0 Non-Handed*	313 Dark Bronze Anodized
	1 Radius	3 1-1/8"	5 LH or RHR	335 Black Anodized
	1W Radius with weatherstrip		6 RH or LHR	628 Clear Anodized
	2 Bevel			

\*Any flat or radius faceplate. Select handing for bevel faceplate only.

## 1870HM Cylinder-Operated Flushbolt

MODEL & CYLINDER HEIGHT	STANDARD 13-1/2" CYLINDER HEIGHT	CYLINDER HEIGHT OVER 13-1/2" (SPECIFY)
1870HM For hollow metal, 313, 335, or 628 finish, 1-1/4" backset	\$168	\$222

For cylinder height greater than 13-1/2" up to maximum cylinder height 65" please contact factory.



### How to Order

Specify quantity and the following information. Order related products separately

PRODUCT NO.	FACEPLATE SHAPE	FINISH
187	0HM	-628
	0HM Flat	313 Dark Bronze Anodized
		335 Black Anodized
		628 Clear Anodized

## 1877 Cylinder-Operated Flushbolt

MODEL & CYLINDER HEIGHT	STANDARD 13-1/2" CYLINDER HEIGHT	CYLINDER HEIGHT OVER 13-1/2" (SPECIFY)
1877 For wood, 313 or 628 finish, 1-1/4" backset	\$205	\$258
1877 For wood, 605 or 626 finish, 1-1/4" backset	\$295	\$349

For cylinder height greater than 13-1/2" up to maximum cylinder height 57-1/2" please contact factory.



### How to Order

Specify quantity and the following information. Order related products separately

PRODUCT NO.	FINISH
1877	-628
	313 Dark Bronze Anodized
	605 Bright Brass
	626 Satin Chrome
	628 Clear Anodized

## MS1880, MS1881 Two-Point Flushbolts

MODELS & FINISHES		119, 121, 682
MS1880	Flushbolt with hourglass shaped turn	\$160
MS1881	Flushbolt with teardrop shaped turn	\$160
KITTED OPTION		
MODEL		PRICE
TDK-1880	Tall door kit for doors over 84", up to 144" maximum	\$30

**How to Order** Specify quantity and the following information. Order related products separately

PRODUCT NO.	TURN SHAPE	CYLINDER HEIGHT*	FINISH
MS188	0	-01	-682
MS188	0 Hourglass	01 31" to 35"	119 to Match 335 Black Anodized
	1 Teardrop	02 35-1/16" to 39"	121 to Match 313 Dark Bronze Anodized
		03 39-1/16" 43"	682 Satin Chrome
		04 43-1/16" to 47"	
		05 47-1/16" to 51"	

\*Distance from floor to cylinder centerline.



## MS2180 Auto-Release Two-Point Flushbolt

MODELS & FINISHES		119, 121, 130
MS2180	Hourglass shaped turn, 7', 8', 9', 10' door height	\$239
MS2181	Teardrop shaped turn, 7', 8', 9', 10' door height	\$239
MS2182	Flush operator, 7', 8', 9', 10' door height	\$239

**How to Order** Specify quantity and the following information. Order related products separately

PRODUCT NO.	TURN SHAPE	DOOR HEIGHT (FROM FLOOR TO TOP OF DOOR)	FINISH TO MATCH
MS218	0	-07	-130
	0 Hourglass	07 Up to 7' Door	119 to Match 335 Black Anodized
	1 Teardrop	08 Up to 8' Door	121 to Match 313 Dark Bronze Anodized
		09 Up to 9' Door	
	2 Flush Operator	10 Up to 10' Door	130 to Match 628 Clear Anodized



## 4189, 4190 Flush Locksets (Including Deadlock)

MODELS & FINISHES	STANDARD LOCK FACE	STAINLESS STEEL LOCK FACE
4189-IB Flush lockset, 119, 121, or 130 finish, individually boxed	\$105	\$116
4190-IB Flush lockset, 119, 121, or 130 finish, individually boxed with cylinder	\$138	\$148
4195-IB Dummy flushset, 119, 121, or 130 finish, individually boxed	\$72	\$83
SPECIAL MODEL		
4189-00 Flush operator without lock	\$83	
4190-00 Flush operator without lock	\$116	



### Kitted Options

MODELS	GRAY
4413-01, 4413-02 Grip pull for use with 4189, 4190	\$25

### How to Order Specify quantity and the following information. Order related products separately

PRODUCT NO.	LOCKSET EXTERIOR	LOCK FACE	STILE THICKNESS	FINISH	KEYING OPTIONS*	PACKAGING
41	90	-09	-1	-130	-01	IB
	89 Without Cylinder	00 Without Lock	1 1" to 1-3/8"	119 To match 335 Black Anodized	00 Without Cylinder	IB Individually Boxed
	90 With Cylinder	09 Radius	2 1-7/16" to 1-5/8"	121 To match 313 Dark Bronze Anodized	01 Keyed Different	
	95 Dummy	09S Radius Stainless Steel	3 1-11/16" to 2"	130 To match 628 Clear Anodized	02 Keyed alike in pairs	
		10 Square				
		10S Square Stainless Steel				

\*Keyed alike 50 are available by special order in quantity of 50 locksets only. Please contact factory for ordering information.

## 4430, 4431 Flush Locksets (Including Deadlock)

MODELS & FINISH	STANDARD LOCK FACE	STAINLESS STEEL LOCK FACE
4430-IB ABS flush lockset, individually boxed	\$72	\$83
4431-IB ABS flush lockset with cylinder, individually boxed	\$110	\$121
4432-IB ABS dummy flushset, individually boxed	\$36	\$46
SPECIAL MODEL		
4430-00 ABS operator without lock	\$51	
4431-00 ABS operator without lock	\$89	



### Kitted Options

MODELS & FINISHES	335
4453-02-335-IB Grip pull for use with 4430, 4431	\$67

### How to Order Specify quantity and the following information. Order related products separately

PRODUCT NO.	LOCKSET EXTERIOR	LOCK FACE	STILE THICKNESS	KEYING OPTIONS*	PACKAGING
44	31	-09	-05	-01	-IB
	30 Without Cylinder	00 Without Lock	00 1" to 1-5/16"	00 Without Cylinder	IB Individually Boxed
	31 With Cylinder	09 Radius	05 1-3/8" to 1-5/8"	01 Keyed Different	
	32 Dummy	09S Radius Stainless Steel	08 1-3/4" to 2"	02 Keyed alike in pairs	
		10 Square			
		10S Square Stainless Steel			

\*Keyed alike 50 are available by special order in quantity of 50 locksets only. Please contact factory for ordering information.

## EXIT DEVICES

Alarm option cannot be combined with any other Device Option or Monitoring Option. Split finishes (faceplate/pushbar) are not available. Matching end cap option available for US finishes only. Please contact factory for specific ordering questions.

### 8099 Dummy Pushbar



MODELS & FINISHES	313, 335, 628	US4, US32D	US3, US32
8099-00 Dummy pushbar without mechanism, for doors NOT requiring an exit device.	\$265	\$559	\$627
8099-M0 Active dummy bar without latching mechanism, without monitoring switches.	\$346	—	—
8099-M1 Active dummy bar with monitoring switch but without latching mechanism. May be wired normally open or normally closed to operate maglock, alarm or similar.	\$408	\$702	\$770
8099-M2 Active dummy bar with two monitoring switches but without latching mechanism. May be wired normally open or normally closed to operate maglock, alarm or similar.	\$477	\$771	\$839

**How to Order** Specify quantity and the following information. Order related products separately

PRODUCT NO.	MONITOR	DOOR TYPE	PUSHBAR FINISH	WIDTH	US FINISH
8099	-M1	-3	0	36	-US32
	00 Inactive Dummy Bar	3 Aluminum	0 US Finish	30 30 inches	US3 Bright Brass
	M0 Active Dummy Bar, no monitoring switches	4 Wood or hollow metal	1 Clear Anodized 628	36 36 inches	US4 Satin Brass
	M1 Active Dummy Bar, one monitoring switch		2 Dark Bronze Anodized 313	42 42 inches	32 Bright Stainless
	M2 Active Dummy Bar, two monitoring switches		3 Black Anodized 335	48 48 inches	32D Satin Stainless

### 8100 | 3100 Surface Vertical Rod Exit Device

MODELS & FINISHES	313, 335, 628	US4, US32D	US3, US32
8100 Surface vertical rod exit device for wood and hollow metal	\$1,047	\$1,393	\$1,576
8100T Top rod only (less bottom rod) SVR exit device	\$960	\$1,306	\$1,489
3100 Fire-rated surface vertical rod exit device for wood and hollow metal	\$1,334	\$1,680	\$1,863
3100T Fire-rated top rod only (less bottom rod) for metal doors	\$1,248	\$1,594	\$1,777
3100W Fire-rated top rod only (less bottom rod) for wood doors	\$1,248	\$1,594	\$1,777

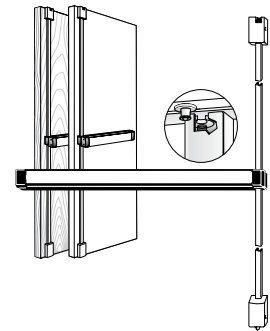

#### Kitted Options

MODELS & FINISHES	313, 335, 628	US4, US32D	US3, US32
3055 Tall door kit for doors up to 10' tall, for use with 3100	\$134	\$170	\$201

**How to Order** Specify quantity and the following information. Order related products separately

MODEL	PUSHBAR FINISH	ROD TYPE	DEVICE OPTIONS	MONITORING OPTION	DOOR OPENING WIDTH ON PAIR OF DOORS, SPECIFY HALF OF THE TOTAL EXIT OPENING	US FINISH	END CAPS OPTION FOR US FINISH
81	00	-	MLR	M2	-30	-US32D	MEC
31 Fire-Rated	00 US Finish	T Top Rod only	LR Electric Latch Retraction (solenoid)	M Single Switch	30 30 inches*	US3 Bright Brass	MEC Matching END Caps
81 Life-Safety	11 Clear Anodized 628	W Top Rod only - Wood doors	MLR Motorized Latch Retraction	M2 Dual Switch	36 36 inches	US4 Satin Brass	
	22 Dark Bronze Anodized 313	- Standard rod	C Cylinder Dogging (non-fire rated devices ONLY)	(BLANK) NO Monitor	42 42 inches	US32 Bright Stainless	
	33 Black Anodized 335		ED Electric Dogging		48 48 inches	US32D Satin Stainless	
			(BLANK) No Option		AXXB Alarmed Exit Device where XX is door opening width		

\*Please note that 30" exit devices cannot accommodate monitoring options EXCEPT when ordered in conjunction with the MLR option.



## 8200 Narrow Stile Surface Vertical Rod Exit Device

MODELS & FINISHES	313, 335, 628	US4, US32D	US3, US32
8200 Narrow stile surface vertical rod exit device	\$984	\$1,329	\$1,513
8200T Top rod only (less bottom rod) SVR exit device	\$897	\$1,242	\$1,426
SPECIAL MODELS	313, 335, 628	US4, US32D	US3, US32
8200-99 SVR exit device, less rods	\$867	\$1,206	\$1,387

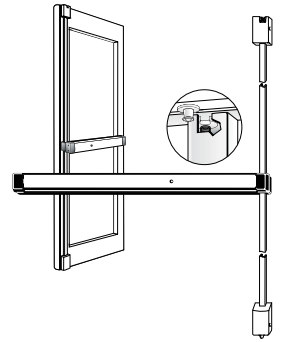

### Kitted Options

MODELS & FINISHES	313, 335, 628	US4, US32D	US3, US32
8055-01 Tall door kit for doors up to 10' tall, for use with 8100, 8200	\$128	\$173	\$206

### How to Order Specify quantity and the following information. Order related products separately

MODEL	PUSHBAR FINISH	ROD TYPE	DEVICE OPTIONS	MONITORING OPTION	DOOR OPENING WIDTH ON PAIR OF DOORS, SPECIFY HALF OF THE TOTAL EXIT OPENING	US FINISH	END CAPS OPTION FOR US FINISH
82	00	-	ED	M2	-36	-US3	
82 Life-Safety	00 US Finish	T Top Rod only	LR Electric Latch Retraction (solenoid)	M Single Switch	30 30 inches	US3 Bright Brass	MEC Matching End Caps
	11 Clear Anodized 628	- Standard rod		M2 Dual Switch	36 36 inches	US4 Satin Brass	
	22 Dark Bronze Anodized 313		MLR Motorized Latch Retraction	(BLANK) NO Option	42 42 inches	US32 Bright Stainless	
	33 Black Anodized 335		C Cylinder Dogging		48 48 inches	US32D Satin Stainless	
			ED Electric Dogging		AXXB Alarmed Exit Device where XX is door opening width		
		(BLANK) No Option					

## 8300 | 3300 Mortise Exit Device

MODELS & FINISHES	313, 335, 628	US4, US32D	US3, US32
8300 Mortise exit device for wood and hollow metal	\$811	\$1,157	\$1,237
3300 Fire-rated mortise exit device for wood and hollow metal	\$1,156	\$1,502	\$1,582

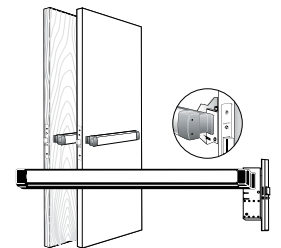

### Kitted Options

MODELS & FINISH	US32D
4009-01 Open back strike for 1-3/4" thick doors	\$150

For complete list of kitted options for mortise exit devices, please refer to 8400 Narrow Stile Mortise Exit Devices on next page.

### How to Order Specify quantity and the following information. Order related products separately

MODEL	FACEPLATE FINISH	FACE SHAPE	DEVICE OPTIONS	MONITORING OPTION	DOOR HANDING	PUSHBAR FINISH	DOOR OPENING WIDTH ON PAIR OF DOORS, SPECIFY HALF OF THE TOTAL EXIT OPENING	US FINISH	END CAPS OPTION FOR US FINISH
83	3	0	ED	M	-7	3	A36B		
33 Fire-Rated	0 US Finish	0 Flat (3300 only)	LR Electric Latch Retraction (solenoid)	M Single Switch	7 RHR	0 US Finish	30 30 inches*	US3 Bright Brass	MEC Matching End Caps
			MLR Motorized Latch Retraction	M2 Dual Switch	8 LHR	1 Clear Anodized 628	36 36 inches	US4 Satin Brass	
			C Cylinder Dogging (non-fire rated devices ONLY)	(BLANK) No Monitor		2 Dark Bronze Anodized 313	42 42 inches	US32 Bright Stainless	
			ED Electric Dogging			3 Black Anodized 335	48 48 inches	US32D Satin Stainless	
83 Life-Safety	1 Clear Anodized 628	2 Bevel (8300 only)	- Without Options				AXXB Alarmed Exit Device where XX is door opening width		

\* Please note that 30" exit devices cannot accommodate monitoring options EXCEPT when ordered in conjunction with the MLR option.

US adamsrite.com | 800.872.3267 | customerservice.adamsrite@assaabloy.com  
 CANADA assaabloydss.ca | 800.461.3007 | sales.dss.ca@assaabloy.com



## 8400 Narrow Stile Mortise Exit Device

MODEL & FINISHES	313, 335, 628	US4, US32D	US3, US32
8400 Narrow stile mortise exit device	\$725	\$1,069	\$1,185

Please contact factory for information on the 8475 Midpanel Mortise Exit Device. Pricing is standard pricing plus unique door cutting charge for custom cut length.

### Kitted Options

MODELS	US32D
8455-01 Long face strike for covering MS strike prep	\$104
8460-17-630 Long lip strike for jambs that project outward 2-1/4" beyond the centerline of door	\$79
91-0995-02-IP 2" thick door kit for use with 8300, 8400	\$19
91-0995-03-IP 2-1/4" thick door kit for use with 8300, 8400	\$19
91-0995-04-IP 2-1/2" thick door kit for use with 8300, 8400	\$22
91-0995-05-IP 2-3/4" thick door kit for use with 8300, 8400	\$27
91-0995-06-IP 3" thick door kit for use with 8300, 8400	\$27
91-0325-01 Thermal door kit, 1/4" cladding, for use with 8400	\$84
91-0325-02 Thermal door kit, 1/2" cladding, for use with 8400	\$153

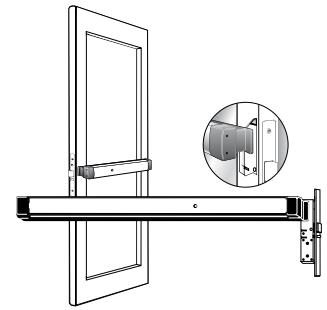

### How to Order Specify quantity and the following information. Order related products separately

MODEL	FACEPLATE FINISH	FACE SHAPE	DEVICE OPTIONS	MONITORING OPTION	BACKSET	DOOR HANDING	PUSHBAR FINISH	DOOR OPENING WIDTH ON PAIR OF DOORS, SPECIFY HALF OF THE TOTAL EXIT OPENING	US FINISH	END CAPS OPTION FOR US FINISH
84	1	4	MLR	M2	-4	7	1	42		
84 Life-Safety	0 US Finish	0 Flat, Radius, Bevel	LR Electric Latch Retraction (solenoid)	M Switch	2 31/32"	7 RHR	0 US Finish	30 30 inches	US3 Bright Brass	MEC Matching End Caps
	1 Clear Anodized 628							36 36 inches		
	2 Dark Bronze Anodized 313	42 42 inches								
	3 Black Anodized 335	48 48 inches								
		4 Radius w/ Weatherstrip*	MLR Motorized Latch Retraction	(BLANK) No Monitor	3 1-1/8"	8 LHR	1 Clear Anodized 628	42 42 inches	US4 Satin Brass	
			C Cylinder Dogging		4 1-1/2"		2 Dark Bronze Anodized 313	48 48 inches	US32 Bright Stainless	
			ED Electric Dogging				3 Black Anodized 335	AXXB Alarmed Exit Device where XX is door opening width	US32D Satin Stainless	
			- Without Options							

\*Radius with weatherstrip faceplate is not available in US finishes.

## 8500 | 3600 Metal Door Concealed Vertical Rod Exit Device

MODELS & FINISHES	313, 335, 628	US4, US32D	US3, US32
8500 Concealed vertical rod exit device for hollow metal	\$765	\$1,111	\$1,227
8500T Top rod only (less bottom rod) CVR exit device	\$678	\$1,024	\$1,140
3600 Fire-rated concealed vertical rod exit device for hollow metal	\$1,248	\$1,594	\$1,710
3600T Fire-rated top rod only (less bottom rod) CVR exit device	\$1,162	\$1,508	\$1,624

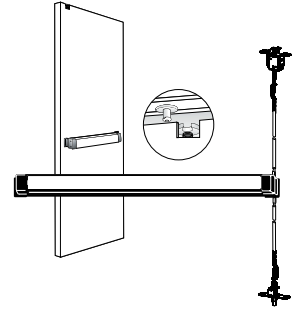

### Kitted Options

MODEL	PRICE
3655 Tall door kit for doors taller than 66" above bar height, up to 10'	\$65

### How to Order Specify quantity and the following information. Order related products separately

MODEL	PUSHBAR FINISH	ROD TYPE	DEVICE OPTIONS	MONITORING OPTION	DOOR OPENING WIDTH ON PAIR OF DOORS, SPECIFY HALF OF THE TOTAL EXIT OPENING	US FINISH	END CAPS OPTION FOR US FINISH
85	00	T	ED	M	-36	-US32D	
36 Fire-Rated	00 US Finish	T Top Rod only	LR Electric Latch Retraction (solenoid)	M Single Switch	30 30 inches*	US3 Bright Brass	MEC Matching End Caps
85 Life-Safety	11 Clear Anodized 628	- Standard rod	MLR Motorized Latch Retraction	M2 Dual Switch	36 36 inches	US4 Satin Brass	
	22 Dark Bronze Anodized 313			(BLANK) No Monitor	42 42 inches	US32 Bright Stainless	
	33 Black Anodized 335			C Cylinder Dogging (non-fire rated devices only)	48 48 inches	US32D Satin Stainless	
				ED Electric Dogging	AXXB Alarmed Exit Device where XX is door opening width		
		(BLANK) No Option					

\* Please note that 30" exit devices cannot accommodate monitoring options EXCEPT when ordered in conjunction with the MLR option.

## 8600 Narrow Stile Concealed Vertical Rod Exit Device

MODELS & FINISHES	313, 335, 628	US4, US32D	US3, US32
8600 Narrow stile concealed vertical rod exit device	\$713	\$1,059	\$1,175
8600T Top rod only (less bottom rod) CVR exit device	\$626	\$972	\$1,088
SPECIAL MODELS			
8600-99 CVR exit device, less rods	\$615	\$961	\$1,077

Please contact factory for information on the 8675 Midpanel CVR Exit Device. Pricing is standard pricing plus unique door cutting charge for custom cut length.

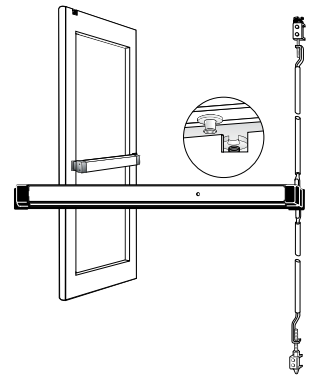

### Kitted Options

MODEL	PRICE
8655 Tall door kit for doors up to 10' for use with 8500, 8600	\$59

### How to Order Specify quantity and the following information. Order related products separately

MODEL	PUSHBAR FINISH	ROD TYPE	DEVICE OPTIONS	MONITORING OPTION	DOOR OPENING WIDTH ON PAIR OF DOORS, SPECIFY HALF OF THE TOTAL EXIT OPENING	US FINISH	END CAPS OPTION FOR US FINISH
86	22	T	MLR	M2	-36		
86 Life-Safety	00 US Finish	T Top Rod only	LR Electric Latch Retraction (solenoid)	M Single Switch	30 30 inches	US3 Bright Brass	MEC Matching End Caps
	11 Clear Anodized 628	- Standard rod	MLR Motorized Latch Retraction	M2 Dual Switch	36 36 inches	US4 Satin Brass	
	22 Dark Bronze Anodized 313			(BLANK) No Monitor	42 42 inches	US32 Bright Stainless	
	33 Black Anodized 335			C Cylinder Dogging	48 48 inches	US32D Satin Stainless	
				ED Electric Dogging	AXXB Alarmed Exit Device where XX is door opening width		
		(BLANK) No Option					

## 8700 | 3700 Rim Exit Device

MODELS & FINISHES	313, 335, 628	US4, US32D	US3, US32
8700 Surface concealed vertical rod exit device for wood	\$524	\$846	\$939
3700 Fire-rated surface concealed vertical rod for wood	\$868	\$1,190	\$1,283

### Kitted Options

MODEL	PRICE
3889-08 Mullion for doors up to 8' for use with 8700, 3700	\$584

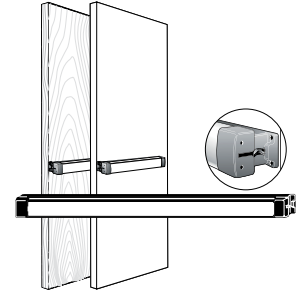

### How to Order Specify quantity and the following information. Order related products separately

MODEL	PUSHBAR FINISH	DEVICE OPTIONS	MONITORING OPTION	DOOR OPENING WIDTH ON PAIR OF DOORS, SPECIFY HALF OF THE TOTAL EXIT OPENING	US FINISH	END CAPS OPTION FOR US FINISH	VOLTAGE
87	00	EL	M2	-36	-US32		-12
37 Fire-Rated	00 US Finish	EL Electric Latch Retraction (solenoid)	M Single Switch	30 30 inches*	US3 Bright Brass	MEC Matching End Caps	12 Volts
87 Life-Safety	01 Clear Anodized 628		M2 Dual Switch	36 36 inches	US4 Satin Brass		24 Volts
	02 Dark Bronze Anodized 313	MLR Motorized Latch Retraction	(BLANK) No Monitor	42 42 inches	US32 Bright Stainless		
		C Cylinder Dogging (non-fire rated devices only)		48 48 inches			
	03 Black Anodized 335	ED Electric Dogging		AXXB Alarmed Exit Device where XX is door opening width	US32D Satin Stainless		
		(BLANK) No Option					

\*Please note that 30" exit devices cannot accommodate monitoring options EXCEPT when ordered in conjunction with the MLR option.

## 8800 Narrow Stile Rim Exit Device

MODEL & FINISHES	313, 335, 628	US4, US32D	US3, US32
8800 Narrow stile rim exit device	\$500	\$822	\$915

### Kitted Options

MODELS	313, 628
3890-08 Aluminum mullion for doors up to 8' for use with 8800	\$610
3890-10 Aluminum mullion for doors up to 10' for use with 8800	\$637

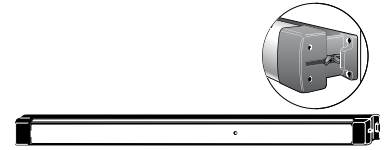

### How to Order Specify quantity and the following information. Order related products separately

MODEL	PUSHBAR FINISH	DEVICE OPTIONS	MONITORING OPTION	DOOR OPENING WIDTH ON PAIR OF DOORS, SPECIFY HALF OF THE TOTAL EXIT OPENING	US FINISH	END CAPS OPTION FOR US FINISH	VOLTAGE
88	01	C	M2	-36			-12
88 Life-Safety	00 US Finish	EL Electric Latch Retraction (solenoid)	M Single Switch	30 30 inches	US3 Bright Brass	MEC Matching End Caps	12 Volts
	01 Clear Anodized 628		M2 Dual Switch	36 36 inches	US4 Satin Brass		24 Volts
	02 Dark Bronze Anodized 313	MLR Motorized Latch Retraction	(BLANK) No Monitor	42 42 inches	US32 Bright Stainless		
		C Cylinder Dogging (non-fire rated devices only)		48 48 inches			
	03 Black Anodized 335	ED Electric Dogging		AXXB Alarmed Exit Device where XX is door opening width	US32D Satin Stainless		
		(BLANK) No Option					

\*Please note that 30" exit devices cannot accommodate monitoring options EXCEPT when ordered in conjunction with the MLR option.

## 8900 | 3900 Wood Door Surface Concealed Vertical Rod Exit Device

MODELS & FINISHES	313, 335, 628	US4, US32D	US3, US32
8900 Surface concealed vertical rod exit device for wood	\$846	\$1,192	\$1,308
3900 Fire-rated surface concealed vertical rod for wood	\$1,328	\$1,674	\$1,790

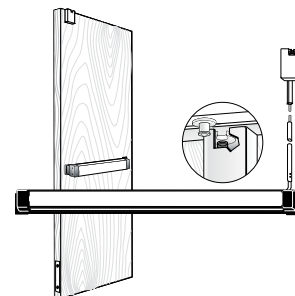

### Kitted Options

MODEL	PRICE
8955-01 Tall door kit for doors up to 10' for use with 8900	\$62
3955-01 Tall door kit for doors up to 10' for use with 3900	\$62

**How to Order** Specify quantity and the following information. Order related products separately

MODEL	PUSHBAR FINISH	DEVICE OPTIONS	MONITORING OPTION	DOOR OPENING WIDTH ON PAIR OF DOORS, SPECIFY HALF OF THE TOTAL EXIT OPENING	US FINISH	END CAPS OPTION FOR US FINISH
89	00	LR	M2	-36	-US32	
39 Fire-Rated	00 US Finish	LR Electric Latch Retraction (solenoid)	M Single Switch	30 30 inches*	US3 Bright Brass	MEC Matching End Caps
89 Life-Safety	11 Clear Anodized 628		M2 Dual Switch	36 36 inches	US4 Satin Brass	
	22 Dark Bronze Anodized 313	MLR Motorized Latch Retraction	(BLANK) No Monitor	42 42 inches	US32 Bright Stainless	
	33 Black Anodized 335	C Cylinder Dogging (non-fire rated devices only)		48 48 inches	US32D Satin Stainless	
		ED Electric Dogging		AXXB Alarmed Exit Device where XX is door opening width		
		(BLANK) No Option				

\*Please note that 30" exit devices cannot accommodate monitoring options EXCEPT when ordered in conjunction with the MLR option.

## Accessories for 8000 | 3000 Series Exit Devices

OPTIONS & FINISHES	N/A	US4, US32D	US3, US32
ALARM Battery-operated alarmed exit device. Alarm option cannot be combined with any other device option or monitoring options.	\$517		
C Cylinder dogging	\$56		
ED Electric dogging	\$456		
EL Electric latch retraction (solenoid) for use with 3700, 8700, 8800 rim exit devices only	\$395		
ELD Electric latch retraction (solenoid) with mechanical dogging for rim exit devices only	\$450		
LR Electric latch retraction (solenoid) for use with CVR, Mortise and SVR exit devices.	\$673		
MEC Matching end caps. For US finishes only, not applicable to anodized finishes		\$89	\$117
M1 Monitor/single signal switch	\$139		
M2 Monitor/dual signal switch	\$206		
MLR Motorized latch retraction	\$724		

### Kitted Options for Exit Devices

MODELS & FINISHES	N/A	313, 335, 628	US4, US32D	US3, US32	119, 121, 652
ALARM EXIT KIT Kit for retrofitting an alarm function to an existing Adams Rite exit device Includes new pushbar, end caps and installation hardware		\$657	\$906	\$973	
91-0897-01 Single signal switch kit, retrofits to 3000/8000	\$118				
91-0897-02 Dual signal switch kit, retrofits to 3000/8000	\$185				
26-0584-XXX-MP Sex bolts, 2 per bag, 2 kits required per exit device					\$29

## Modification Options for 8000 | 3000 Series Exit Devices

Please contact factory for all product modifications.

MODELS	ADD
THICK DOOR For doors thicker than 1-3/4" and/or door skins plus reinforcement thicker than those specified in the Adams Rite Master Reinforcement Sheet template, for CVR and Mortise Exit Devices	\$72
UNIQUE DOOR Cutting charges for non-standard custom cut lengths between 30" and 48"	\$95

Please note that thick door modification options are available for 8300, 8400, and 8600 series exit devices only.

US [adamsrite.com](http://adamsrite.com) | 800.872.3267 | [customerservice.adamsrite@assaabloy.com](mailto:customerservice.adamsrite@assaabloy.com)  
 CANADA [assaabloydss.ca](http://assaabloydss.ca) | 800.461.3007 | [sales.dss.ca@assaabloy.com](mailto:sales.dss.ca@assaabloy.com)

Patent pending and/or patent [www.assaabloydss.com/patents](http://www.assaabloydss.com/patents). Copyright © 2019, Hanchett Entry Systems, Inc., an ASSA ABLOY Group company. All rights reserved. Reproduction in whole or in part without the express written permission of Hanchett Entry Systems, Inc. is prohibited.

UPDATED October 31, 2019



## EX76 Concealed Vertical Rod Exit Device

MODEL & FINISHES	313, 335, 628
EX76 CVR exit device for aluminum and hollow metal applications	\$820



## EX80 Dummy Push Bar

MODEL & FINISHES	313, 335, 628
EX80 Dummy push bar for aluminum, hollow metal or wood applications. Includes two monitoring switches. Field selectable for active or inactive configuration	\$549



## EX88 Interlocking Rim Exit Device

MODEL & FINISHES	313, 335, 628
EX88 Interlocking rim exit device for aluminum, hollow metal or wood applications.	\$575



## EX89 Pullman Rim Exit Device

MODEL & FINISHES	313, 335, 628
EX89 Pullman rim exit device for aluminum, hollow metal or wood applications.	\$575



## EX Series How to Order

Specify quantity and the following information. Order related products separately

FAMILY	RATING	LENGTH	FINISHES	DEVICE OPTIONS*
EX89	-	R	628	
EX76	Life Safety	R Regular (36")	313 Dark Bronze Anodized	M Monitoring
EX80		M Midlength (42")	335 Black Anodized	BLANK standard, no options
EX88		L Long (48")	628 Clear Anodized	
EX89				

\*Device options not applicable to Dummy Push Bar. Dummy Push Bar comes standard with dual monitoring switches.

## EX Series Options

MODELS	ADD
MONITOR Dual Signal Switch	\$224

# ELECTRIC STRIKES

## 7100, 7101 Electric Strikes

MODELS & FINISHES	313, 335, 628	626
<b>7100</b> For aluminum jambs	\$195	\$220
<b>7101</b> For radius aluminum stiles	\$195	—
<b>7100-XX7, 7100-XX9</b> Monitoring signal switches	\$300	\$325

Lip Extensions up to 3" for center-hung or non-flush doors add \$36.



How to Order Specify quantity and the following information. Order related products separately

PRODUCT NO.	FACEPLATE SHAPE	VOLTAGE	CURRENT AND DUTY	FEATURES*	FINISH**	LIP EXTENSIONS (DIM. A)*** (DOOR CENTERLINE TO JAMB EDGE)	
710	0	-3	1	0	-628	-00	
	0 Flat	3 12 Volt	1 DC Continuous or Intermittent	0 Standard/Fail-Secure	313 Dark Bronze Anodized	00 1-1/16" or less	05 2"
	1 Radius	4 16 Volt		5 Fail-Safe	335 Black Anodized	01 1-1/2"	07 2-1/4"
		5 24 Volt	4 AC Intermittent	7 Monitored/ Fail-Safe	626 Satin Chrome	02 1-5/8"	09 2-1/2"
				9 Monitored/ Fail-Secure	628 Clear Anodized	03 1-3/4"	12 2-7/8"

\*Fail-secure can be converted to fail-safe and vice versa. \*\*7101 available in 313, 335, 628 only \*\*\*Lip Extensions not available on 7101.

## 7110, 7111 Electric Strikes

MODELS & FINISHES	652
<b>7110</b> For wood jambs	\$230
<b>7111</b> For wood jambs, long faceplate	\$230
<b>7110-XX7, 7110-XX9</b> Monitoring signal switches	\$335

Lip Extensions up to 3" for center-hung or non-flush doors add \$36.



How to Order Specify quantity and the following information. Order related products separately

PRODUCT NO.	FACEPLATE LENGTH	VOLTAGE	CURRENT AND DUTY	FEATURES*	FINISH	LIP EXTENSIONS (DIM. A) (DOOR CENTERLINE TO JAMB EDGE)	
711	0	-3	1	0	-652	-00	
	0 7-15/16"	3 12 Volt	1 DC Continuous or Intermittent	0 Standard/Fail-Secure	652 Satin Chrome	00 1-1/16" or less	05 2"
	1 10-1/4"	4 16 Volt		5 Fail-Safe		01 1-1/2"	07 2-1/4"
		5 24 Volt	4 AC Intermittent	7 Monitored/ Fail-Safe		02 1-5/8"	09 2-1/2"
				9 Monitored/ Fail-Secure		03 1-3/4"	12 2-7/8"

\*Fail-secure can be converted to fail-safe and vice versa.

## 7130, 7131 Electric Strikes

MODELS & FINISHES	313, 335, 628
<b>7130</b> For aluminum jambs, pre-cut for MS lock strike plate	\$199
<b>7131</b> For radius aluminum stiles, pre-cut for MS lock strike plate	\$199
<b>7130-XX7, 7130-XX9</b> Monitoring signal switch	\$304

Lip Extensions up to 3" for center-hung or non-flush doors add \$36.



How to Order Specify quantity and the following information. Order related products separately

PRODUCT NO.	FACEPLATE SHAPE	VOLTAGE	CURRENT AND DUTY	FEATURES*	FINISH	LIP EXTENSIONS (DIM. A)** (DOOR CENTERLINE TO JAMB EDGE)	
713	0	-3	1	0	-313	-00	
	0 Flat	3 12 Volt	1 DC Continuous or Intermittent	0 Standard/Fail-Secure	313 Dark Bronze Anodized	00 1-1/16" or less	05 2"
	1 Radius	4 16 Volt	4 AC Intermittent	5 Fail-Safe	335 Black Anodized	01 1-1/2"	07 2-1/4"
		5 24 Volt		7 Monitored/ Fail-Safe	628 Clear Anodized	02 1-5/8"	09 2-1/2"
				9 Monitored/ Fail-Secure		03 1-3/4"	12 2-7/8"

\*Fail-secure can be converted to fail-safe and vice versa. \*\*Lip extensions not available on 7131.

## 7140 Electric Strike

MODEL & FINISHES	313, 335, 628	626
<b>7140</b> ANSI size for hollow metal and wood jambs	\$195	\$220
<b>7140-XX7, 7140-XX9</b> Monitoring signal switch	\$300	\$325

Lip Extensions up to 3" for center-hung or non-flush doors add \$36.



How to Order Specify quantity and the following information. Order related products separately

PRODUCT NO.	VOLTAGE	CURRENT AND DUTY	FEATURES*	FINISH	LIP EXTENSIONS (DIM. A) (DOOR CENTERLINE TO JAMB EDGE)	
7140	-3	1	0	-628	-00	
	3 12 Volt	1 DC Continuous or Intermittent	0 Standard/ Fail-Secure	313 Dark Bronze Anodized	00 1-1/16" or less	05 2"
	4 16 Volt	4 AC Intermittent	5 Fail-Safe	335 Black Anodized	50 1-3/8"	07 2-1/4"
	5 24 Volt		7 Monitor/Fail-Safe	626 Satin Chrome	01 1-1/2"	09 2-1/2"
			9 Monitor/Fail-Secure	628 Clear Anodized	02 1-5/8"	12 2-7/8"
					03 1-3/4"	

\*Fail-secure can be converted to fail-safe and vice versa.

## 7160 Electric Strike

MODELS & FINISHES	313, 335, 628	626
<b>7160</b> For aluminum jambs	\$249	\$275
<b>7160-XX7, 7160-XX9</b> Monitoring signal switches	\$354	\$380

Lip Extensions up to 3" for center-hung or non-flush doors add \$36.



How to Order Specify quantity and the following information. Order related products separately

PRODUCT NO.	VOLTAGE	CURRENT AND DUTY	FEATURES*	FINISH	LIP EXTENSIONS (DIM. A) (DOOR CENTERLINE TO JAMB EDGE)	
7160	-3	1	0	-628	-00	
	3 12 Volt	1 DC Continuous or Intermittent	0 Standard/Fail-Secure	313 Dark Bronze Anodized	00 1-1/16" or less	05 2"
	4 16 Volt	4 AC Intermittent	5 Fail-Safe	335 Black Anodized	01 1-1/2"	07 2-1/4"
	5 24 Volt		7 Monitor/Fail-Safe	626 Satin Chrome	02 1-5/8"	09 2-1/2"
			9 Monitor/Fail-Secure	628 Clear Anodized	03 1-3/4"	12 2-7/8"

\*Fail-secure can be converted to fail-safe and vice versa.



## 7170 Electric Strike

MODELS & FINISHES	313, 335, 628	626
7170 For hollow metal and wood jambs	\$249	\$275
7170-XX7, 7170-XX9 Monitoring signal switches	\$354	\$380

Lip Extensions up to 3" for center-hung or non-flush doors add \$36.



How to Order Specify quantity and the following information. Order related products separately

PRODUCT NO.	VOLTAGE	CURRENT AND DUTY	FEATURES*	FINISH	LIP EXTENSIONS (DIM. A) DOOR CENTERLINE TO JAMB EDGE	
7170	-3	1	0	-628	-00	
	3 12 Volt	1 DC Continuous or Intermittent	0 Standard/Fail-Secure	313 Dark Bronze Anodized	00 1-1/16" or less	05 2"
	4 16 Volt		5 Fail-Safe	335 Black Anodized	50 1-3/8"	07 2-1/4"
	5 24 Volt	4 AC Intermittent	7 Monitor/Fail-Safe	626 Satin Chrome	01 1-1/2"	09 2-1/2"
			9 Monitor/Fail-Secure	628 Clear Anodized	02 1-5/8"	12 2-7/8"
					03 1-3/4"	

\*Fail-secure can be converted to fail-safe and vice versa.

## 7100 Series Electric Strike Components

STRIKE BODY KITS	PRICE
7103A For use with 7100/7101, 7110/7111, 7130/7131, 7140	\$165
7173A For use with 7160, 7170	\$213

One strike body kit matched with one faceplate kit makes a complete electric strike assembly.

FACEPLATE KITS & FINISHES	313, 335, 628	626	605
FPK00 For use with body kits: 7103A, 7173A	\$33	\$59	\$65
FPK01 For use with body kit: 7103A	\$33		
FACEPLATE KITS & FINISHES		652	632
FPK10 For use with body kit: 7103A		\$69	\$97
FPK11 For use with body kits: 7103A		\$69	\$97
FACEPLATE KITS & FINISHES	313, 335, 628	626	605
FPK30 For use with body kit: 7103A	\$38		
FPK31 For use with body kits: 7103A	\$38		
FPK40 For use with body kit: 7103A, 7173A	\$33	\$59	\$65
FPK45 For use with body kit: 7103A, for installing electric strike in previous prep, 4901, 4501 strike cover.	\$38		

Faceplate kits contain all hardware to mount electric strike.

## Kitted Options

MODELS	PRICE
91-0171-01-IP THROUGH -13-IP Lip extension kits for use with 7100 through 7140	\$38
91-0171-50-IP Lip extension kits for use with 7100 through 7140 interior framing systems	\$38
91-0172-01-IP THROUGH -13-IP Lip extension kits for use with 7160 and 7170	\$38
91-0172-50-IP Lip extension kits for use with 7160 and 7170 interior framing systems	\$38

How to Order Specify quantity and the following information. Order related products separately

PRODUCT NO.	VOLTAGE	CURRENT AND DUTY	FEATURES*
7103A	3	1	0
7103A	3 12 Volt	1 DC Continuous or Intermittent	0 Standard/Fail-Secure
7173A	4 16 Volt	4 AC Intermittent	5 Fail-Safe
	5 24 Volt		

\*Fail-secure can be field converted to fail-safe or vice versa.

US [adamsrite.com](http://adamsrite.com) | 800.872.3267 | [customerservice.adamsrite@assaabloy.com](mailto:customerservice.adamsrite@assaabloy.com)  
 CANADA [assaabloydss.ca](http://assaabloydss.ca) | 800.461.3007 | [sales.dss.ca@assaabloy.com](mailto:sales.dss.ca@assaabloy.com)

Patent pending and/or patent [www.assaabloydss.com/patents](http://www.assaabloydss.com/patents). Copyright © 2019, Hanchett Entry Systems, Inc., an ASSA ABLOY Group company. All rights reserved. Reproduction in whole or in part without the express written permission of Hanchett Entry Systems, Inc. is prohibited.

UPDATED October 31, 2019

 Adams  
Rite  
**ASSA ABLOY**

## 7240 Fire-Rated Electric Strike

MODELS & FINISH		630
7240	Fire-rated, for cylindrical latches	\$375
7240-50	Lip extension for interior frame systems	\$412
7240-XX9	Monitoring signal switches	\$482



How to Order Specify quantity and the following information. Order related products separately

PRODUCT NO.	VOLTAGE	CURRENT AND DUTY	FEATURES*	FINISH	LIP EXTENSIONS (DIM. A) DOOR CENTERLINE TO JAM EDGE FOR INTERIOR FRAMES
7240	-3	1	0	-630	-50
	3 12 Volt	1 DC Continuous or Intermittent	0 Fail-Secure	630 Satin Stainless	00 1-1/16" or less
	5 24 Volt	4 AC Intermittent	9 Monitor/Fail-Secure		50 1-3/8"

\*Not available in fail-safe.

## 7270 Fire-Rated Electric Strike

MODELS & FINISH		630
7270	Fire-rated, for mortise latches	\$435
7270-50	Lip extension for interior frame systems	\$471
7270-XX9	Monitoring signal switches	\$542



How to Order Specify quantity and the following information. Order related products separately

PRODUCT NO.	VOLTAGE	CURRENT AND DUTY	FEATURES*	FINISH	LIP EXTENSIONS (DIM. A) DOOR CENTERLINE TO JAM EDGE FOR INTERIOR FRAMES
7270	-3	1	0	-630	-50
	3 12 Volt	1 DC Continuous or Intermittent	0 Fail-Secure	630 Satin Stainless	00 1-1/16" or less
	5 24 Volt	4 AC Intermittent	9 Monitor/Fail-Secure		50 1-3/8"

\*Not available in fail-safe.

## 7400, 7401 Ultraline Electric Strikes

MODELS & FINISHES		313, 335, 628	630	605, 606, 629	119, 121, 130
7400	For radius jambs	\$267	\$300	\$311	
7400M	Monitoring signal switches	\$372	\$400	\$418	
7401	For radius aluminum stiles				\$267
7401M	Monitoring signal switches				\$379



How to Order Specify quantity and the following information. Order related products separately

PRODUCT NO.	FACEPLATE SHAPE	FEATURES	FINISH		
740	0	M	628		
	0 Flat	- None	7400 ONLY		7401 ONLY
	1 Radius	M Monitored A Modular Pack - Body Kit	313 Dark Bronze Anodized	628 Clear Anodized	119 To match 335 Black Anodized
			335 Black Anodized	629 Bright Stainless	121 To match 313 Dark Bronze Anodized
			605 Bright Brass	630 Satin Stainless	130 To match 628 Clear Anodized
			606 Satin Brass		

Fail-secure can be converted to fail-safe and vice versa.

## 7410, 7411 Ultraline Electric Strikes

MODELS & FINISHES	313, 335, 628	630
<b>7410</b> For wood jambs, 7-15/16" faceplate	\$300	\$327
<b>7410M</b> Monitoring signal switches	\$413	\$432
<b>7411</b> For wood jambs, 10-1/4" faceplate, not available in 335 Finish	\$306	\$333
<b>7411M</b> Monitoring signal switches		\$432

How to Order Specify quantity and the following information. Order related products separately

PRODUCT NO.	FACEPLATE LENGTH	FEATURES	FINISH	
741	0	-	628	
	0 7-15/16"	- None	313 Dark Bronze Anodized	628 Clear Anodized
	1 10-1/4"	M Monitored	335 Black Anodized	630 Satin Stainless

*Fail-secure can be converted to fail-safe and vice versa.*

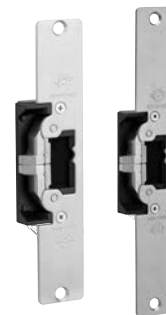

## 7430, 7431 Ultraline® Electric Strikes

MODELS & FINISHES	313, 335, 628	119, 121, 130
<b>7430</b> For aluminum jambs, flat faceplate	\$273	
<b>7430M</b> Monitoring signal switches	\$385	
<b>7431</b> For aluminum stiles, radius faceplate		\$273
<b>7431M</b> Monitoring signal switches, not available in 119 finish.		\$385

How to Order Specify quantity and the following information. Order related products separately

PRODUCT NO.	FACEPLATE SHAPE	FEATURES	FINISH	
743	0	M	628	
	0 Flat	- None	313 Dark Bronze Anodized	119 To match 335 Black Anodized
	1 Radius	M Monitored	335 Black Anodized	121 To match 313 Dark Bronze Anodized
			628 Clear Anodized	130 To match 628 Clear Anodized

*Fail-secure can be converted to fail-safe and vice versa.*



## 7440 Ultraline Electric Strikes

MODELS & FINISHES	313, 335, 628	630	605, 606, 629
<b>7440</b> For steel and wood, jambs and doors	\$267	\$295	\$311
<b>7440M</b> Monitoring signal switches	\$372	\$400	\$418

*Fail-secure can be converted to fail-safe and vice versa.*

How to Order Specify quantity and the following information. Order related products separately

PRODUCT NO.	FEATURES	FINISH		
7440	M	628		
	- None	313 Dark Bronze Anodized	606 Satin Brass	629 Bright Stainless
	M Monitored	335 Black Anodized	628 Clear Anodized	630 Satin Stainless
		605 Bright Brass		

*Fail-secure can be converted to fail-safe and vice versa.*



## 74R1 Ultraline Electric Strikes

MODELS & FINISHES	119, 121, 130
<b>74R1</b> For use with rim exit devices with 3/4" latchbolt	<b>\$364</b>
<b>74R1M</b> Monitoring signal switches	<b>\$469</b>

How to Order Specify quantity and the following information. Order related products separately

PRODUCT NO.	FEATURES	FINISH
74R1	M	-130
	- None	119 To match 335 Black Anodized
	M Monitored	121 To match 313 Dark Bronze Anodized
		130 To match 628 Clear Anodized

*Fail-secure can be converted to fail-safe and vice versa.*



## 74R2 Ultraline Electric Strike

MODELS & FINISHES	119, 121, 130
<b>74R2</b> For use with narrow stile rim exit devices with 1/2" latchbolt	<b>\$364</b>

How to Order Specify quantity and the following information. Order related products separately

PRODUCT NO.	FINISH
74R2	-130
	119 To match 335 Black Anodized
	121 To match 313 Dark Bronze Anodized
	130 To match 628 Clear Anodized

*Fail-secure can be field converted to fail-safe or vice-versa.*



MODULAR PACKING PROGRAM — match strike body kit with faceplate kit for complete electric strike.  
Select 7400A for standard jambs and 7401A for radius stile mounting. No finish designation required for strike body kits.

## 7400 Series Electric Strike Components

STRIKE BODY KITS	PRICE
7400A Standard body, for use in single door applications	\$248
7401A Radius body, for use in applications with pairs of doors	\$248

Match one strike body kit with one faceplate kit to make a complete electric strike assembly.

FACEPLATE KITS & FINISHES	313, 335, 628	630	605, 606, 629	119, 121, 130
FPK7400 For use with body kit: 7400A	\$27	\$55	\$65	
FPK7401 For use with body kit: 7401A				\$27
FPK7410 For use with body kit: 7400A	\$60	\$84		
FPK7411 For use with body kit: 7400A, not available in 335 finish	\$65	\$90		
FPK7430 For use with body kit: 7400A	\$32			
FPK7431 For use with body kit: 7401A				\$32
FPK7440 For use with body kit: 7400A	\$27	\$55	\$65	
FPK7445 For use with body kit: 7400A, not available in 335 finish. For installing electric strike in previous prep 4901, 4501, strike cover	\$38			

Faceplate kits contain all hardware to mount electric strike.

### Kitted Options

MODELS	PRICES
LEK7400 Lip extension kits for use with 7400 series electric strikes, for flat faceplates only	\$47
VA7400-12 12 VDC adapter cable for 7400 electric strikes	\$13
VA7400-16VDC 16 VDC adapter kit for 7400 electric strikes	\$21
VA7400-24 24 VDC adapter cable for 7400 electric strikes	\$13
WDC7400 Wood door cover plate for use when mounting 7400 in the inactive leaf of a wood door pair (to simplify the mortising operation)	\$14
ELX ElectroLynx™ Adapter to connect Adams Rite products to the ElectroLynx system	\$33

How to Order Specify quantity and the following information. Order related products separately

PRODUCT NO.	LIP EXTENSIONS (DISTANCE FROM VERTICAL CENTERLINE OF THE DOOR IN THE CLOSED POSITION TO THE EDGE OF THE JAMB)							
LEK7400	-00							
	01 1-1/2"	03 1-3/4"	05 2"	07 2-1/4"	09 2-1/2"	11 2-3/4"	13 3"	
	02 1-5/8"	04 1-7/8"	06 2-1/8"	08 2-3/8"	10 2-5/8"	12 2-7/8"	50 1-3/8"	

## 7800 Series Electric Strike

MODELS & FINISHES	630	613E, 628E, BSP	606	605,629
7800 For use with Starwheel and Interlocking rim exit devices.	\$625	\$657	\$698	\$711

### Accessories

MODELS & FINISHES	630, 613E, 628E, BSP
7800-116-XXX 1/16" Spacer plate	\$28
7800-108-XXX 1/8" Spacer plate	\$31
7800-SMB Surface Mounting Box	\$212

How to Order Specify quantity and the following information. Order related products separately

PRODUCT NO.	FEATURES*	FINISH
7800	—	628
	- None	605 Bright Brass
	L Latchbolt monitor (coming soon)	606 Satin Brass
	M Monitored (coming soon)	613E Dark Oxidized Satin Bronze Powder
		628E Satin Aluminum Clear Anodized
		629 Bright Stainless
		630 Satin Stainless
		BSP Black Suede Powder

\*Fail-secure can be field converted to fail-safe and vice versa.







# TRIM

## 1000 Series Turns

MODELS & FINISHES	119, 121, 130
1000-01, 1000-02 Turn for use with MS1847 deadlock	\$29
1000-11, 1000-21 Stainless steel turn and escutcheon for use with MS1847 deadlock	\$35
1004 Turn for use with 5015, 5017 deadlock	\$35
1015 Turn for use with 5015, 5017 deadlock	\$35
1016 Outside escutcheon	\$29



How to Order Specify quantity and the following information. Order related products separately

PRODUCT NO.	TURN TYPE	SPINDLE LENGTH	FINISH																																																																								
1000	-21	-14	-130																																																																								
	<b>TURN WITHOUT ESCUTCHEON</b> FURNISHED Unassembled  <b>-01</b> PARALLEL Drive  <b>-02</b> PENDICULAR Drive	DASH CHART <table border="1"> <thead> <tr> <th>NO.</th> <th>"L"</th> <th>MM</th> <th>NO.</th> <th>"L"</th> <th>MM</th> </tr> </thead> <tbody> <tr><td>-11</td><td>17/32</td><td>13</td><td>-22</td><td>1-15/64</td><td>31</td></tr> <tr><td>-12</td><td>39/64</td><td>15</td><td>-23</td><td>1-19/64</td><td>33</td></tr> <tr><td>-13</td><td>43/64</td><td>17</td><td>-24</td><td>1-23/64</td><td>35</td></tr> <tr><td>-14</td><td>47/64</td><td>19</td><td>-25</td><td>1-27/64</td><td>36</td></tr> <tr><td>-15</td><td>51/64</td><td>20</td><td>-26</td><td>1-31/64</td><td>38</td></tr> <tr><td>-16</td><td>55/64</td><td>22</td><td>-27</td><td>1-33/64</td><td>39</td></tr> <tr><td>-17</td><td>59/64</td><td>23</td><td>-28</td><td>1-39/64</td><td>41</td></tr> <tr><td>-18</td><td>63/64</td><td>25</td><td>-29</td><td>1-43/64</td><td>42</td></tr> <tr><td>-19</td><td>1-3/64</td><td>26</td><td>-30</td><td>1-47/64</td><td>44</td></tr> <tr><td>-20</td><td>1-7/64</td><td>28</td><td>-31</td><td>1-51/64</td><td>46</td></tr> <tr><td>-21</td><td>1-11/64</td><td>30</td><td>-32</td><td>1-55/64</td><td>47</td></tr> </tbody> </table>	NO.	"L"	MM	NO.	"L"	MM	-11	17/32	13	-22	1-15/64	31	-12	39/64	15	-23	1-19/64	33	-13	43/64	17	-24	1-23/64	35	-14	47/64	19	-25	1-27/64	36	-15	51/64	20	-26	1-31/64	38	-16	55/64	22	-27	1-33/64	39	-17	59/64	23	-28	1-39/64	41	-18	63/64	25	-29	1-43/64	42	-19	1-3/64	26	-30	1-47/64	44	-20	1-7/64	28	-31	1-51/64	46	-21	1-11/64	30	-32	1-55/64	47	119 To match 335 Black Anodized 121 To match 313 Dark Bronze Anodized 130 To match 628 Clear Anodized
NO.	"L"	MM	NO.	"L"	MM																																																																						
-11	17/32	13	-22	1-15/64	31																																																																						
-12	39/64	15	-23	1-19/64	33																																																																						
-13	43/64	17	-24	1-23/64	35																																																																						
-14	47/64	19	-25	1-27/64	36																																																																						
-15	51/64	20	-26	1-31/64	38																																																																						
-16	55/64	22	-27	1-33/64	39																																																																						
-17	59/64	23	-28	1-39/64	41																																																																						
-18	63/64	25	-29	1-43/64	42																																																																						
-19	1-3/64	26	-30	1-47/64	44																																																																						
-20	1-7/64	28	-31	1-51/64	46																																																																						
-21	1-11/64	30	-32	1-55/64	47																																																																						
	<b>TURN WITH ESCUTCHEON</b> FURNISHED Assembled  <b>-11</b> PARALLEL Drive  <b>-21</b> PENDICULAR Drive																																																																										

## 3000 Fixed Pull

MODELS & FINISH	US32D
3001 Tubular fixed pull for hollow metal or wood doors	\$209
3002 Flat fixed pull for hollow metal or wood doors	\$232

How to Order Specify quantity and the following information. Order related products separately

PRODUCT NO.	HANDLE	CYLINDER HOLE	EXIT DEVICE	FINISH
300	1	-1	1	-US32D
	1 Round	1 Without Hole	1 Mortise, Rim	US32D Satin Stainless
	2 Flat	2 With Hole	2 CVR	
			3 SVR	

Not for use with the following narrow stile exit devices: 8200 SVR, 8400 Mortise, 8600 CVR, 8800 Rim Exit Devices.

## 3080 Series Entry Trim

MODELS & FINISHES		STANDARD TRIM		ELECTRIFIED TRIM	
		US4, US32D, 10B	US3, US32	US4, US32D, 10B	UUS3, US32
STANDARD LEVER	3080 Entry trim with standard lever (01, 02, 03)	\$372	\$410	\$720	\$758
	3080-M Entry trim with standard lever (01, 02, 03) with matching trim cover finish	\$469	\$507	\$817	\$855
	3080-U Entry trim with standard lever (01, 02, 03) with universal trim kit includes tailpieces and trimplates for use with all Adams Rite exit devices	\$398	\$436	\$746	\$784
	3080-U, M Entry trim with standard lever (01, 02, 03), matching trim cover and universal trim kit	\$495	\$533	\$843	\$881
DESIGNER LEVER	3080-MX Entry trim with designer lever series (MD through MW)	\$420	\$458	\$768	\$806
	3080-MX, M Entry trim with designer lever series (MD through MW) with matching trim cover	\$517	\$555	\$865	\$903
	3080-MX, U Entry trim with designer lever series (MD through MW) with universal trim kit	\$446	\$484	\$794	\$832
	3080-MX, U, M Entry trim with designer lever series (MD through MW), universal trim kit and matching trim cover	\$543	\$581	\$891	\$929

Tactile strip now available as a Kitted Option (below) for standard levers 01 and 03.



### Kitted Options

MODELS	PRICE
91-0686 Adaptor kit for 3080 trim and G86 exit device	\$32
91-0118 Tactile strip for 3080 standard levers 01, 03	\$39

### How to Order Specify quantity and the following information. Order related products separately

PRODUCT NO.	ELECTRIFIED	HANDLE	HANDING	CYLINDER HOLE	EXIT DEVICE	VOLTAGE	FEATURES	TRIM COVER FINISH	FINISH
3080	E	-01	-0	-3	7	-3	0	M	US32D
	(BLANK) Standard	STANDARD Handles	0 No Handing	3 With Hole	1 SVR	ELECTRIFIED Trim Only	ELECTRIFIED Trim Only	- Standard (Black)	US3 Bright Brass
	E Electrified Trim	01 Curve	7 Left Hand*	9 Without Hole	3 Mortise	3 12 Volt DC	0 Fail-Secure	M Matching Finish	US4 Satin Brass
		02 Round	8 Right Hand*		4 SCVR	5 24 Volt DC	5 Fail-Safe		10B Dark Bronze
		03 Square			6 CVR				US32 Bright Stainless
		DESIGNER Series			7 Rim	U Universal Kit	US32D Satin Stainless		
		MD MJ							
		ME MN* (Handed)							
		MG MV* (Handed)							
		MI MW							

\* Handing must be specified for MN and MV Designer Levers.



## 3090 eForce® Keyless Entry

MODELS & FINISHES	FOR DEADLATCHES & EXITS	FOR DEADLOCKS
		626, 121
3090-01, 3090-02 eForce keyless entry with keypad	3090-01	3090-02
	\$795	\$818

### Kitted Options

MODELS	PRICE
RSK-3090 Remote switch input connector	\$18

How to Order Specify quantity and the following information. Order related products separately

PRODUCT NO.	COMPATIBLE PRODUCTS	FINISH
3090	-01	-626
	01 Adams Rite latches or 8000 Series Exit Devices, Yale 7200 series, Corbin Russwin ED4000 series exit devices only	121 To match 313 Dark Bronze Anodized
	02 Adams Rite MS® deadlocks	626 Satin Chrome

NOTE: Adams Rite eForce 3090P & 3090C were discontinued as of November 16, 2018. Customers can continue to order eForce 3090-150 and the A100-3090H (Aperio).



## A100-3090H Keyless Entry and Aperio® Hub Pre-Paired Kit

MODELS & FINISHES	FOR DEADLATCHES & EXITS	FOR DEADLOCKS
		121, 626
A100-3090HC Keyless entry paired with hub, iCLASS reader	\$1,970	\$1,994
A100-3090HP Keyless entry paired with hub, PROX reader	\$1,970	\$1,994

*Special pricing program discounts apply to Aperio products. Please contact your sales representative for pricing information.*

### Kitted Options

MODELS	PRICE
DPS-C-38G A100 Door Position Switch	\$36

How to Order Specify quantity and the following information. Order related products separately

PRODUCT NO.	CREDENTIAL	COMPATIBLE PRODUCTS	FINISH
A100-3090H	C	-1	-626
	P 125 kHz HID® Prox	1 Adams Rite latches or 8000 Series Exit Devices, Yale 7200 series, Corbin Russwin ED4000 series exit devices only (select REX enabled version).	121 To match 313 Dark Bronze Anodized
	C 13.56 MHz HID iCLASS	2 Adams Rite MS® deadlocks	626 Satin Chrome

NOTE: The Adams Rite A100 narrow stile trim is available as either a pre-paired lock and hub kit (no certification required) or as a field configurable component (requires Aperio® Certified Integrator certification). Pre-paired kits support limited features, field configured devices are required in order to support all options. Visit [www.IntelligentOpenings.com](http://www.IntelligentOpenings.com) to learn more.



## 4060 Turn

MODEL & FINISH	130
4060 Turn for 1875 deadlock, 1-1/2", 1-3/4", or 2" door thickness	\$64

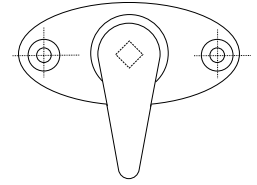

**How to Order** Specify quantity and the following information. Order related products separately

PRODUCT NO.	DOOR THICKNESS	FINISH
4060	-05	-130
	05 1-1/2"	130 To match 628 Clear Anodized
	06 1-3/4"	
	07 2"	

Please contact factory regarding mounting spacers, bolts, guides and strikes for particular door designs.

## 4550 MS® Deadlock Lever

MODEL & FINISHES	119, 121, 130
4550, 01 Deadlock lever, 1-3/4" to 2" door thickness	\$208
4550, 02 Deadlock lever, 2-1/8" to 2-3/8" door thickness	\$250



**How to Order** Specify quantity and the following information. Order related products separately

PRODUCT NO.	DOOR HAND	DOOR THICKNESS	FINISH
4550	R	-01	-130
	R RH or RHR	01 1-3/4" to 2"	119 To match 335 Black Anodized
	L LH or LHR	02 2-1/8" to 2-3/8"	121 To match 313 Dark Bronze Anodized
			130 To match 628 Clear Anodized

## 4560, 4565 Series Deadlatch Handles for 4300, 4500, 4900 Deadlatches

MODELS & FINISHES	119, 121, 130
4560-X01 For door thickness (01) 1-3/4" to 2"	\$56
4560-X02 For door thickness (02) 2-1/4" to 2-1/2"	\$77
4560-X03 For door thickness (03) 2-3/4" to 3"	\$77
4560-X04 For door thickness (04) 3-1/4"	\$77
4565-X01 For door thickness (01) 1-3/4" to 2"	\$56
4565-X02 For door thickness (02) 2-1/4" to 2-1/2"	\$77
4565-X03 For door thickness (03) 2-3/4" to 3"	\$77
4565-X04 For door thickness (04) 3-1/4"	\$77



## 4560-010, 4565-010 Series Deadlatch Handles for MS+1890 Deadlock/Deadlatch

MODELS & FINISHES	119, 121, 130
4560-011 For door thickness (11) 1-3/4"	\$41
4560-012 For door thickness (12) 1-3/4" to 2-1/4"	\$51
4560-013 For door thickness (13) 2-15/16" to 2-3/4"	\$51
4565-011 For door thickness (11) 1-3/4"	\$41
4565-012 For door thickness (12) 1-3/4" to 2-1/4"	\$51

How to Order Specify quantity and the following information. Order related products separately

PRODUCT NO.	HANDLE TYPE	HANDING	DOOR THICKNESS		FINISH
456	0	-5	01		-130
	0 Lever	0 Using MS+1890	FOR 4300, 4500, 4900 Series Deadlatches	FOR MS+1890	119 To match 335 Black Anodized
	5 Turn	5 LH or LHR			121 To match 313 Dark Bronze Anodized
		6 RH or RHR	01 1-3/4" to 2"	11 1-3/4"	130 To match 628 Clear Anodized
			02 2-1/4" to 2-1/2"	12 1-3/4" to 2-1/4"	
			03 2-3/4" to 3"	13 2-5/16" to 2-3/4"	
			04 3-1/4"		

## 4568, 4569 Eurostyle Deadlatch Handles for 4300, 4500, 4900 Deadlatches

MODELS & FINISHES	119, 121, 130
4568-X01 For door thickness (01) 1-3/4" to 2"	\$67
4568-X02 For door thickness (02) 2-1/4" to 2-1/2"	\$83
4568-X03 For door thickness (03) 2-3/4" to 3"	\$83
4568-X04 For door thickness (04) 3-1/4"	\$83
4569-X01 For door thickness (01) 1-3/4" to 2"	\$76
4569-X02 For door thickness (02) 2-1/4" to 2-1/2"	\$91
4569-X03 For door thickness (03) 2-3/4" to 3"	\$91
4569-X04 For door thickness (04) 3-1/4"	\$91



## 4568-010, 4569-010 Series Deadlatch Handles for MS+1890 Deadlock/Deadlatch

MODELS & FINISHES	119, 121, 130
4568-011 For door thickness (11) 1-3/4" to 1-15/16"	\$55
4568-012 For door thickness (12) 2" to 2-1/4"	\$65
4568-013 For door thickness (13) 2-15/16" to 2-3/4"	\$65
4568-014 For door thickness (14) 3"	\$65
4569-011 For door thickness (11) 1-3/4" to 1-15/16"	\$60
4569-012 For door thickness (12) 2" to 2-1/4"	\$70
4569-013 For door thickness (13) 2-15/16" to 2-3/4"	\$70
4569-014 For door thickness (14) 3"	\$70

How to Order Specify quantity and the following information. Order related products separately

PRODUCT NO.	LEVER TYPE	HANDING	DOOR THICKNESS		FINISH
456	8	-5	01		-130
	8 Straight	0 Using MS+1890	FOR 4300, 4500, 4900 Series Deadlatches	FOR MS+1890	119 To match 335 Black Anodized
	9 Return End	5 LH or LHR			121 To match 313 Dark Bronze Anodized
		6 RH or RHR	02 2-1/4" to 2-1/2"	12 2" to 2-1/4"	130 To match 628 Clear Anodized
			03 2-3/4" to 3"	13 2-5/16" to 2-3/4"	
			04 3-1/4"	14 3"	

## 4590 Deadlatch Paddle for 4300, 4500, 4900 Deadlatches

MODELS & FINISHES		313, 335, 628
4590-0X-00	For door thickness (00) 1-3/4"	\$110
4590-0X-01	For door thickness (01) 1-13/16" to 2"	\$131
4590-0X-02	For door thickness (02) 2-1/4" to 2-1/2"	\$131
4590-0X-03	For door thickness (03) 2-3/4" to 3"	\$131
4590-0X-04	For door thickness (04) 3-1/4"	\$131

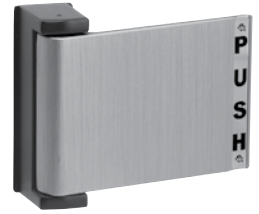

## 4590 Deadlatch Paddle for MS+1890, 2190 Deadlocks

MODELS & FINISHES		313, 335, 628
4590-1X-00	For door thickness (00) 1-3/4"	\$93
4590-1X-01	For door thickness (01) 1-3/4" to 2-1/4"	\$114
4590-1X-02	For door thickness (02) 2-5/16" to 2-1/2"	\$114
4590-1X-03	For door thickness (03) 2-9/16" to 2-3/4"	\$114

How to Order Specify quantity and the following information. Order related products separately

PRODUCT NO.	OPERATION			DOOR THICKNESS		FINISH*
4590	02			-00		-313
	FIRST DASH FOR LATCH SERIES	OPERATION	USE	FOR 4300, 4500, 4900 SERIES Deadlatches	FOR MS+1890, 2190	313 Dark Bronze Anodized 335 Black Anodized 628 Clear Anodized
	-01 4300/4500/4900	PULL TO LEFT		OUTSIDE of left hand reverse door or inside of right hand	00 1-3/4"	00 1-3/4"
	-11 MS+1890/2190				01 1-13/16" to 2"	
	-02 4300/4500/4900	PUSH TO LEFT		OUTSIDE of left hand door or inside of right hand reverse	02 2-1/4" to 2-1/2"	02 2-5/16" to 2-1/2"
	-12 MS+1890/2190				03 2-3/4" to 3"	
	-03 4300/4500/4900	PULL TO RIGHT		OUTSIDE of right hand reverse door or inside or left hand	04 3-1/4"	
	-13 MS+1890/2190					
	-04 4300/4500/4900	PUSH TO RIGHT		OUTSIDE of right hand door or inside of left hand reverse	04 3-1/4"	
	-14 MS+1890/2190					
	<b>LH</b>  -03 OR -13 -02 OR -12		<b>RH</b>  -01 OR -11 -04 OR -14			
	<b>LHR</b>  -04 OR -14 -01 OR -11		<b>RHR</b>  -02 OR -12 -03 OR -13			

\*Finish applied to paddle assembly only, not escutcheon.

## 4591 Deadlatch Paddle for 4300, 4500, 4900 Deadlatches

MODELS & FINISHES	313, 335, 628	US3, US26D
4591-0X-00 For door thickness (00) 1-3/4"	\$131	\$247
4591-0X-01 For door thickness (01) 1-13/16" to 2"	\$153	\$269
4591-0X-02 For door thickness (02) 2-1/4" to 2-1/2"	\$153	\$269
4591-0X-03 For door thickness (03) 2-3/4" to 3"	\$153	\$269
4591-0X-04 For door thickness (04) 3-1/4"	\$153	\$269







## 4591 Deadlatch Paddle for MS+1890, 2190 Deadlocks

MODELS & FINISHES	313, 335, 628	US3, US26D
4591-1X-00 For door thickness (00) 1-3/4"	\$113	\$229
4591-1X-01 For door thickness (01) 1-3/4" to 2-1/4"	\$135	\$251
4591-1X-02 For door thickness (02) 2-5/16" to 2-1/2"	\$135	\$251
4591-1X-03 For door thickness (03) 2-9/16" to 2-3/4"	\$135	\$251

### Options

MODELS	PRICES
4591MA Active paddle, latch activator with monitor switch	Add \$118
4591M Paddle with switch, no latch activator	Add \$102
91-0914 Monitor switch kit for 4591, field installation	\$118

How to Order Specify quantity and the following information. Order related products separately

PRODUCT NO.	OPTIONS*	OPERATION			DOOR THICKNESS		FINISH**	
4591	M	02			-00		-313	
	- Standard Paddle	FIRST DASH FOR LATCH SERIES	OPERATION	USE	FOR 4300, 4500, 4900 SERIES DEADLATCHES	FOR MS+1890, 2190	313 Dark Bronze Anodized	
	M Paddle w/ switch only	-01 4300/4500/4900	PULL TO LEFT		OUTSIDE of left hand reverse door or inside OF right hand	00 1-3/4"	00 1-3/4"	335 Black Anodized
	MA Active paddle w/ switch	-11 MS+1890/2190	PUSH TO LEFT		OUTSIDE of left hand door or inside of right hand reverse	01 1-13/16" to 2"	01 1-3/4" to 2-1/4"	628 Clear Anodized
		-02 4300/4500/4900				02 2-1/4" to 2-1/2"	02 2-5/16" to 2-1/2"	US26D Satin Chrome
		-12 MS+1890/2190	PULL TO RIGHT		OUTSIDE of right hand reverse door or inside OR left hand	03 2-3/4" to 3"	03 2-9/16" to 2-3/4"	
		-03 4300/4500/4900				04 3-1/4"		
		-13 MS+1890/2190	PUSH TO RIGHT		OUTSIDE of right hand door or inside of left hand reverse			
		-04 4300/4500/4900						
		-14 MS+1890/2190						

\*M and MA options available on push paddles only, not pull paddles. \*\*Finish applied to paddle assembly only, not escutcheon.

## 4600 Heavy Duty Designer Deadlatch Handles

MODELS & FINISHES		LEVER OPERATOR FOR 4300, 4500, 4900 SERIES DEADLATCHES		LEVER OPERATOR FOR 2190, 2290 INTERCONNECTED DEADBOLT/DEADLATCH	
		10B, US4, US32D	US3, US32	10B, US4, US32D	US3, US32
STANDARD LEVER	4600 Trim with standard lever (01, 02, 03)	\$152	\$192	\$135	\$175
	4600-M Trim with standard lever (01, 02, 03) with form 'C' switch option to indicate when lever is actuated	\$208	\$248	\$191	\$231
	4600-THICK DOOR Trim with standard lever (01, 02, 03) for door thickness greater than 1-7/8"	\$175	\$215	\$158	\$198
DESIGNER LEVER	4600-MX Trim with designer lever series (MD through MW)	\$198	\$238	\$181	\$221
	4600-MX, M Trim with designer lever series (MD through MW) with form 'C' switch option	\$254	\$294	\$237	\$277
	4600-MX, THICK DOOR Trim with designer lever series (MD through MW) for door thickness greater than 1-7/8"	\$221	\$261	\$204	\$244



### Kitted Options

MODELS	PRICES
REX-4600 Request to exit kit	\$44
DTK-4600 Fixed lever (dummy) kit	\$14
TDK-4600-XX Thick door kit. Specify door thickness.*	\$29
TBK-4600-XX Through-bolt mounting kit for back-to-back mounting on wood doors. Specify door thickness.*	\$31

\*For door thickness (01) 1-3/4", (02) 2", (03) 2-1/4", (04) 2-1/2" and (05) 2-3/4".

How to Order Specify quantity and the following information. Order related products separately

PRODUCT NO.	REX	HANDLE	HANDING**	DOOR THICKNESS	COMPATIBLE PRODUCTS	FINISH	
4600	M	-01	-5	1	1	-32D	
	(BLANK) Standard	STANDARD HANDLES	5 LH or LHR	1 1-3/4" to 1-7/8"	1 2190, 2290 Interconnected Deadbolt/Deadlatch	US3 Bright Brass	
	M Switch Option	01 Curve	6 RH or RHR	2 2" to 2-1/8"	2 4300, 4500, 4900 Series Deadlatches	US4 Satin Brass	
		02 Round		3 2-1/4" to 2-3/8"		10B Dark Bronze	
		03 Square		4 2-1/2" to 2-5/8"		US32 Bright Stainless	
		DESIGNER SERIES		5 2-3/4" to 2-7/8"		US32D Satin Stainless	
		MD MJ					
		ME MN* (Handed)					
		MG MV* (Handed)					
	MI MW						

\*Handing must be specified for MN and MV Designer Levers. \*\*Handing - assuming lever on interior of door.

US [adamsrite.com](http://adamsrite.com) | 800.872.3267 | [customerservice.adamsrite@assaabloy.com](mailto:customerservice.adamsrite@assaabloy.com)  
 CANADA [assaabloydss.ca](http://assaabloydss.ca) | 800.461.3007 | [sales.dss.ca@assaabloy.com](mailto:sales.dss.ca@assaabloy.com)

UPDATED October 31, 2019

Patent pending and/or patent [www.assaabloydss.com/patents](http://www.assaabloydss.com/patents). Copyright © 2019, Hanchett Entry Systems, Inc., an ASSA ABLOY Group company. All rights reserved. Reproduction in whole or in part without the express written permission of Hanchett Entry Systems, Inc. is prohibited.

 Adams  
Rite  

# CYLINDERS & ACCESSORIES

## 4024, 4025, 4026 Cylinder Pulls

MODELS & FINISHES	119, 121, 130
4024-00-01, 02 Cylinder pull, Schlage keyway	\$66
4024-06-01, -02 Cylinder pull, Weiser keyway	\$66
4025-00-01, 02 Cylinder pull, Schlage keyway	\$71
4025-06-01, 02 Standard cylinder pull, Weiser keyway	\$71
4025-100-02, CYL X CYL Cylinder both sides pullset, Schlage keyway	\$143
4025-106-02, CYL X CYL Cylinder both sides pullset, Weiser keyway	\$143
4026-00-01, 02 Cylinder pull for use with 5015, 5017 Wood Door Deadlock, Schlage keyway	\$73
4026-06-01, 02 Cylinder pull for use with 5015, 5017 Wood Door Deadlock, Weiser keyway	\$73

Please contact factory for special cylinder requirements.



How to Order Specify quantity and the following information. Order related products separately

PULL TYPE	PULL NO./CYLINDER INCLUDED	KEYING	FINISH
4024	-00	-01	-130
4024 Trim Plate Mounted	00 Schlage "C" Keyway	01 Keyed Different	119 To match 335 Black Anodized
4025 Stile Mounted with through - screws	06 Weiser Keyway	02 Keyed Alike in Pairs	121 To match 313 Dark Bronze Anodized
4026 For Wood Applications			130 To match 628 Clear Anodized

## 4036 Mortise Cylinder

MODEL & FINISHES	313, 335, 628
4036 Five pin cylinder. 2 keys and 1/4" ring, KD, KA2 only For 3300, 3600, 8300, 8400, 8500, 8600, or entry trim. Can be installed directly in latch case of 8400, 8300, or 3300.	\$46



How to Order Specify quantity and the following information. Order related products separately

PRODUCT NO.	LOCK TYPE	KEY OPTIONS*	FINISH
4036	-01	-01	-628
	01 For MS Locks, Deadlatches, 2190	01 Keyed different	313 Dark Bronze Anodized
	02 For 4070 Deadlock	02 Keyed alike in pairs	335 Black Anodized
	03 For 2331 Deadlock		628 Clear Anodized

\* Keyed alike 50 (KA50) are available by special order in quantity of 50 cylinders only. Please contact factory for ordering information.



## MS4043 Cylinder Guard

MODELS & FINISHES	119, 121, 130
MS4043-00 Cylinder guard, 1/8" stile wall, 5 or 6 pin cylinder	\$40
MS4043-01 Cylinder guard, 1/4" stile wall, 5 or 6 pin cylinder	\$45
MS4043-02 Cylinder guard, 1/8" stile wall, 1-5/16" to 1-7/16" long cylinder	\$63



How to Order Specify quantity and the following information. Order related products separately

PRODUCT NO.	STILE WALL & CYLINDER		FINISH
MS4043	-01		-130
	STILE WALL	CYLINDER	119 To match 335 Black Anodized
	00 1/8"	5 or 6 pin	121 To match 313 Dark Bronze Anodized
	01 1/4"	5 or 6 pin	130 To match 628 Clear Anodized
	02 1/8"	1-5/16" to 1-7/16" long	

## 4066 Thumbturn

MODEL & FINISHES	130, 313, 335
4066 Thumbturn cylinder with 1/4" ring	\$46



How to Order Specify quantity and the following information. Order related products separately

PRODUCT NO.	LOCK TYPE	FINISH
4066	-01	-130
	01 For MS Locks, Deadlatches	130 To match 628 Clear Anodized
	02 For 4070 Deadlock	313 Dark Bronze Anodized
	03 For 2331 Deadlock	335 Black Anodized

## 4580 Cam Disc

MODELS	PRICES
4580-X00, 4580-X01 Included with lever handles, door thickness 2" or less	\$20
4580-X02, 4580-X03 Included with lever handles, door thickness greater than 2"	\$28



## 4581 Universal Cam Disc

MODELS	PRICES
4581-01 Universal cam disc, non-handed, for 1-3/4" door thickness (included in 4600)	\$27
4581-02 Universal cam disc, non-handed, for 2" door thickness	\$36
4581-03 Universal cam disc, non-handed, for 2-1/4" door thickness	\$36



How to Order

Specify quantity and the following information. Order related products separately

PRODUCT NO.	DOOR THICKNESS
4581	01
	01 1-3/4"
	02 2"
	03 2-1/4"

## 8650 Cylinder Escutcheon Kit

MODELS & FINISHES	119, 121, 130	313, 335, 628	US4, US32D	US3, US32
8650 Cylinder escutcheon kit for 3600, 8500, 8600 exit devices	\$39	\$66	\$76	\$86
8650 For wall thickness over 1/8" *	\$72	\$98	\$109	\$118

\*Please contact factory for wall thickness greater than 1/8"



## 8736 Rim Cylinder

MODEL & FINISHES	313, 335, 628
8736 Five-pin Rim cylinder for use with 3100, 3700, 8100, 8200, 8700, 8800 exit devices.	\$50

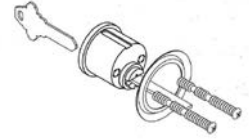

## 4014 Two-Point Conversion Kit

MODEL	PRICE
4014-01 Two-point conversion kit for MS1861 Bottom Rail Deadlock	\$40

## 4015 Threshold Bolt

MODEL & FINISHES	603
4015-18-IB Two-point converter, threshold bolt, standard cylinder height.	\$48
4015-XX-IB Two-point converter, threshold bolt, specify cylinder height greater than 53", 60" maximum.	\$72

How to Order Specify quantity and the following information. Order related products separately

PRODUCT NO.	ADD DASH NUMBER FOR "UNIVERSAL SIZE"	PACKAGING
4015	-18	-IB
		IB Individually Boxed

Please specify cylinder height if ordering in volumn quantity.



## 4016 Header Bolt

MODEL	PRICE
4016 Three-point converter, provides upper bolt for MS1850/1870 Deadlocks	\$62

How to Order Specify quantity and the following information. Order related products separately

PRODUCT NO.	LOCK BACKSET	DOOR HEIGHT
4016	-30	-01
	10 1-1/2"	01 7' Door
	20 31/32"	02 10' Door
	30 1-1/8"	



## 4085 Header Bolt (Pairs of Doors Only)

MODELS & FINISHES	PRICE
4085-01-IB Positioner bolt and header strike, specify cylinder height for 7' door height	\$92
4085-02-IB, 4085-03-IB, 4085-04-IB Positioner bolt and header strike, specify cylinder height for door height greater than 7', door height 10' maximum.	\$114

How to Order Specify quantity and the following information. Order related products separately

PRODUCT NO.	DIMENSION 'A'	PACKAGING
4085	-02	-IB
	01 30" - 52"	IB Individually Boxed
	02 52" - 67"	
	03 67" - 79"	
	04 79" - 92"	

Contact factory for door height greater than 7'.

EXAMPLE			
DOOR Height	CYLINDER Height	A	
96"	- 40"	=	56"

7' Door is 84"  
8' Door is 96"  
9' Door is 108"  
10' Door is 120"



## 4089 Exit Indicator

MODELS & FINISHES	119, 121, 130
4089-00, 4089-01 Indicator for 1-3/4" door, includes both UBC and IBC signs	\$59
4089-20 Indicator for 2" to 2-1/2" door, includes both UBC and IBC signs	\$98

## Accessories

MODELS	PRICES
91-0912 Adapter plate for converting MS1850/4089 installation to deadlatch and lever handle or paddle. Select 121 or 130 finish.	\$36
20-0255-IP Header sign "...During Business Hours"	\$8
20-0256-IP IBC header sign "...Building is Occupied"	\$8

How to Order Specify quantity and the following information. Order related products separately

PRODUCT NO	OPTIONS	FINISH
4089	-01	-130
	00 Standard 1-3/4" Door	119 To match 335 Black Anodized
	01 For Inverted Lock	121 To match 313 Dark Bronze Anodized
	20 For Doors up to 2-1/2"	130 To match 628 Clear Anodized



## 4104 Mounting Bridges

MODELS	PRICE
4104-01 Radius mounting bridge	\$11
4104-02 Flat mounting bridge	\$11
4104-03 Left hand bevel mounting bridge	\$11
4104-04 Right hand bevel mounting bridge	\$11



## 91-0965 Universal Mounting Tab Kits for Installing MS® Locks &amp; Latches

MODELS	PRICE
91-0965 Mounting tab kits for flat/radius stiles	\$17
91-0966 Mounting tab kits for beveled stiles, includes tabs for right hand and left hand bevel doors and mounting screws for clear and dark bronze.	\$17



US [adamsrite.com](http://adamsrite.com) | 800.872.3267 | [customerservice.adamsrite@assaabloy.com](mailto:customerservice.adamsrite@assaabloy.com)  
CANADA [assaabloydss.ca](http://assaabloydss.ca) | 800.461.3007 | [sales.dss.ca@assaabloy.com](mailto:sales.dss.ca@assaabloy.com)

Patent pending and/or patent [www.assaabloydss.com/patents](http://www.assaabloydss.com/patents). Copyright © 2019, Hanchett Entry Systems, Inc., an ASSA ABLOY Group company. All rights reserved. Reproduction in whole or in part without the express written permission of Hanchett Entry Systems, Inc. is prohibited.

UPDATED October 31, 2019

Adams  
Rite  
ASSA ABLOY

## B1921, B1923 Reinforcing Pivots

MODELS & FINISH	PRICE
B1921 1/2" offset to match pivot point of 4" wide butt hinge	\$94
B1923 3/4" offset to match pivot point of 4-1/2" wide butt hinge	\$82



How to Order Specify quantity and the following information. Order related products separately

PRODUCT NO.	MODEL
B192	1
	1 4"
	3 4-1/2"

## STRIKES

### 2190 Dual Force® Interconnected Deadbolt/Deadlatch Strikes

MODELS & FINISHES	630	119, 121
2101-01 Standard flat strike with dust box	\$28	\$35
2101-02 Standard radius strike with dust box	\$28	\$35
MODELS & FINISHES	630	121
2101-XX Strike with extended lip, 4.5" only, flat strike.	\$44	\$51
2102-01 Retrofit strike extended height 7-5/8" with dust box.	\$41	\$48

### 2290 Dual Force® Interconnected Deadbolt/Deadlatch Strikes

MODELS & FINISHES	630	119, 121
2206-01 Standard flat strike with dust box	\$28	\$35
2206-XX Strike with extended lip, specify dimension from strike centerline to frame face, to 4.5" maximum, flat strike only	\$44	

### 4000 Series MS® Deadlock Strikes

MODELS & FINISHES	630	313, 335, 628	US3, US26D	119, 121
4000 Trim Strike		\$29		
4001 Box Strike, includes dust box		\$29	\$51	
MS4002 Armored Strike		\$60	\$82	
4003 ANSI strike, available in 121 or US26D only			\$73	\$73
4005 Strike for 4015 Threshold Bolt	\$22			
4006 Strike for 1830 Bottom Rail Deadlock, also available in 130 finish	\$46			\$53
4009-01 Open back strike for 3300, 8300 Series Mortise Exit Device	\$150			
4170 Trim strike for 4070 Short Throw Deadbolt, not available in 335 finish		\$29		
4505-01 Flat armored box strike for MS+1890 Deadlock/Deadlatch	\$51			\$58
4505-02 Radius armored box strike for MS+1890 Deadlock/Deadlatch	\$51			\$58
4505-17, 4505-21 Flat long lip armored box strike	\$65			\$71



How to Order Specify quantity and the following information. Order related products separately

STRIKE MODEL	TRIM PLATE SHAPE	COMPATIBLE DEADLOCK	TRIM PLATE CORNERS	FINISH
4001	-0	1	1	-313
4000 Trim Strike	0 Flat	1 All Standard MS® locks with 1-3/8" Bolt Throw	1 Square	313 Dark Bronze Anodized
4001 Box Strike	1 Radius	2 1850A-020 with 3/4" Bolt Throw Only	2 Round	335 Black Anodized
MS4002 Armored Strike		3 All MS-050 Hookbolt locks		628 Clear Anodized

## 4800, MS4804 Series Strikes

MODELS & FINISHES	603	630
MS4804-10-630 Reinforcing strike and screws, two-part with reinforcement for strengthening metal jamb		\$22
4801 Metal strike, specify dash number indicating shim quantity	\$18	\$25
4802 Wood strike, specify dash number indicating shim quantity	\$18	\$25
4810-01, 4810-02 Box strike for 5017 Wood Door Deadlock/Deadlatch	\$18	



How to Order Specify quantity and the following information. Order related products separately

PRODUCT NO.	TYPE OF JAMB	DIMENSION 'A'	FINISH
480	1	-02	-630
	1 Metal	01 3/32"	603 Zinc Plated Steel
	2 Wood	02 3/16"	630 Satin Stainless
		03 9/32"	

## 4901, 4902 Deadlatch Strikes

MODELS & FINISHES	630	119, 121
4901-01 Flush mount flat strike, mortised with dust box	\$19	\$25
4901-02 Flush mount radius strike, mortised with dust box	\$19	\$25
4901-XX Extended lip strike, specify lip dim 'A', 2.5" maximum*	\$40	\$43
4902-01 Short box strike, flat with dust box, mounting plate	\$19	\$25
4902-02 Short type box strike, radius with dust box, mounting plate	\$19	\$25
4902-XX Extended lip strike, specify lip dim 'A', 2.5" maximum*	\$40	\$46
4506 Strike for use with 4920AN, not available in 119 finish	\$40	\$46



\*See dim. 'A' dash chart table below.

How to Order Specify quantity and the following information. Order related products separately

PRODUCT NO.	STRIKE TYPE	FACEPLATE SHAPE				FINISH
490	1	-02				630
		STANDARD LIP				119 To match 335 Black Anodized
	1 Long	01	Flat		121 To match 313 Dark Bronze Anodized	
	2 Short	02	Radius		630 Satin Stainless Steel	
		LONG LIP FOR CENTER HUNG DOOR	DIM. 'A'	LONG LIP FOR CENTER HUNG DOOR	DIM. 'A'	
		03 2-1/4" Wide Jamb	1-1/8	13 3-1/2" Wide Jamb	1-3/4	
		05 2-1/2" Wide Jamb	1-1/4	15 3-3/4" Wide Jamb	1-7/8	
		07 2-3/4" Wide Jamb	1-3/8	17 4" Wide Jamb	2	
		09 3" Wide Jamb	1-1/2	19 4-1/4" Wide Jamb	2-1/8	
		11 3-1/4" Wide Jamb	1-5/8	21 4-1/2" Wide Jamb	2-1/4	

## 4304 Deadlatch Strikes

MODEL & FINISHES	630	119, 121
4304 Surface mount strike for 4300 Electrified Deadlatch	\$22	\$29

## THICK DOOR KITS

### 2190, 2290 Dual Force® Interconnected Deadbolt/Deadlatch Thick Door Kit

MODELS	PRICE
2190-TDK-XX Thick door kit for 2190, 2290 standard exterior trim set. Specify door thickness.*	\$65
2190-TDK-CL1, -CL2 Thick door kit for 2190, 2290 clad doors. CL-1 for a standard 1-3/4" thick door with 1/4" cladding. CL-2 for a standard 1-3/4" thick door with 1/2" cladding.	\$65
TDK-4600-XX Thick door kit for 2190, 2290 low profile trim set. Specify door thickness.*	\$29

\*For door thickness (01) 1-3/4", (02) 2", (03) 2-1/4", (04) 2-1/2", (05) 2-3/4", (06) 3", (07) 3-1/4".

### 4568, 4569 Eurostyle Deadlatch Handle Thick Door Kits

MODELS	PRICE
91-0128-02, 91-0128-03, 91-0128-04 Thick door kits for 4568, 4569	\$21
26-0203-01, 26-0203-02, 26-0203-03 Thick door kits for 4568-11, 4569-11	\$21

## FACEPLATES

### MS1850S Deadlock Faceplates

MODELS & FINISHES	313, 628
BFK-MS1850-10 Blank faceplate kit, flat, 1" x 6-7/8"	\$25
BFK-MS1850-11 Blank faceplate kit, radius, 1" x 6-7/8"	\$25

### MS1850S, MS1950 Deadlock (Standard Bolt) Faceplates

MODELS & FINISHES	313, 335, 628	US4, US26D	US3, US26
24-0384-010 Flat faceplate	\$9	\$32	\$37
24-0384-110 Radius faceplate	\$9	\$32	\$37
24-0384-210 Left hand bevel faceplate	\$9	\$32	\$37
24-0384-310 Right hand bevel faceplate	\$9	\$32	\$37
24-0384-410 Radius with weatherstrip	\$12		
SPECIAL MODELS	313, 628		
24-0384-110-313-B100, 24-0384-110-628-B100 Radius faceplates, bulk package of 100 units	\$712		
24-0384-210-313-B100, 24-0384-210-628-B100 Left hand bevel faceplates, bulk package of 100 units	\$712		
24-0384-310-313-B100, 24-0384-310-628-B100 Right hand bevel faceplates, bulk package of 100 units	\$712		
24-0384-410-313-B100, 24-0384-410-628-B100 Radius with weatherstrip faceplates, bulk package of 100 units	\$978		

Please note that all 100 faceplates in the bulk package are of the same finish.

## MS1850S, MS1950 Deadlock (Hookbolt and Short Bolt) Faceplates

MODELS & FINISHES	313, 335, 628	US4, US26D	US3, US26
24-0384-020 Flat faceplate	\$9	\$32	\$37
24-0384-120 Radius faceplate	\$9	\$32	\$37
24-0384-220 Left hand bevel faceplate	\$9	\$32	\$37
24-0384-320 Right hand bevel faceplate	\$9	\$32	\$37
24-0384-420 Radius with weatherstrip	\$12		
SPECIAL MODELS	313, 628		
24-0384-020-313-B100, 24-0384-020-628-B100 Flat faceplates, bulk package of 100 units	\$712		
24-0384-120-313-B100, 24-0384-120-628-B100 Radius faceplates, bulk package of 100 units	\$712		
24-0384-220-313-B100, 24-0384-220-628-B100 Left hand bevel faceplates, bulk package of 100 units	\$712		
24-0384-320-313-B100, 24-0384-320-628-B100 Right hand bevel faceplates, bulk package of 100 units	\$712		
24-0384-420-313-B100, 24-0384-420-628-B100 Radius with weatherstrip faceplates, bulk package of 100 units	\$978		

Please note that all 100 faceplates in the bulk package are of the same finish.

## MS1850SN Deadlock (Standard Bolt) Faceplates

MODELS & FINISHES	313, 335, 628
24-0226-010 Flat faceplate	\$12
24-0226-110 Radius faceplate	\$12
24-0226-210 Left hand bevel faceplate	\$12
24-0226-310 Right hand bevel faceplate	\$12

## MS1850SN-45X Deadlock (Hookbolt) Faceplates

MODELS & FINISHES	313, 335, 628
24-0226-020 Flat faceplate	\$12
24-0226-120 Radius faceplate	\$12
24-0226-220 Left hand bevel faceplate	\$12
24-0226-320 Right hand bevel faceplate	\$12

## 1870 Flushbolt Faceplates

MODELS & FINISHES	313, 335, 628
24-0168-00 Flat faceplate	\$18
24-0168-01 Radius faceplate	\$18
24-0168-02 Left hand bevel faceplate	\$18
24-0168-03 Right hand bevel faceplate	\$18
24-0168-04 Radius with weatherstrip	\$21

## MS+1890 Deadlock Faceplates

MODELS & FINISHES	313, 335, 628
24-0270-020 Flat faceplate	\$11
24-0270-120 Radius faceplate	\$11
24-0270-220 Left hand bevel faceplate	\$11
24-0270-320 Right hand bevel faceplate	\$11
24-0270-420 Radius with weatherstrip	\$15

## 2190 Dual Force® Interconnected Deadbolt/Deadlatch Faceplates

MODELS & FINISHES	313, 628
91-0266-01-313-IP, 91-0266-01-628-IP Flat faceplate and radius faceplate kit for aluminum (2190)	\$40
91-0266-04-313-IP, 91-0266-04-628-IP Flat faceplate and radius faceplate kit for wood or hollow metal (2290)	\$40

## 2331 Heavy Duty Deadbolt Faceplates

MODELS & FINISHES	121	US26D	US3
22-0170 Flat faceplate	\$40	\$40	\$44
22-0032 Strike plate	\$40	\$40	\$44

## 3300 Fire-Rated Mortise Exit Device Faceplates

MODEL & FINISHES	335, 628
24-0015-020 Flat faceplate	\$11

## 4070 Short Throw Deadbolt Faceplates

MODELS & FINISHES	313, 335, 628
24-0136-00 Flat faceplate	\$11
24-0136-10 Radius faceplate	\$11
24-0136-20 Left hand bevel faceplate	\$11
24-0136-30 Right hand bevel faceplate	\$11

## 4500 Standard Duty Deadlatch Faceplates

MODELS & FINISHES	313, 335, 628
24-0017-0220 Flat faceplate	\$9
24-0017-1220 Radius faceplate	\$9
24-0017-2220 Left hand bevel faceplate	\$9
24-0017-3220 Right Hand bevel faceplate	\$9
24-0017-4220 Radius with weatherstrip	\$12

Please note that all 100 faceplates in the bulk package are of the same finish.

## 4530 Standard Duty Deadlatch Faceplates

MODELS & FINISHES	313, 335, 628
24-0016-020 Flat faceplate	\$15
24-0016-120 Radius faceplate	\$15
24-0016-220 Left hand bevel faceplate	\$15
24-0016-320 Right hand bevel faceplate	\$15

## 4900 Heavy Duty Deadlatch Faceplates

MODELS & FINISHES	313, 335, 628	US4, US26D	US3, US26
24-0137-01 Flat or bevel faceplate	\$9	\$32	\$37
24-0137-02 Radius faceplate	\$9	\$32	\$37
24-0137-03 Radius with weatherstrip	\$12		



## 4900 Heavy Duty Deadlatch Special Faceplates

MODELS & FINISHES	313, 628
24-0140 Radius with weatherstrip seal (1-1/8" x 6-7/8")	\$18
24-0144-01 Flat or beveled doors (1-1/8" x 7-1/4")	\$15
24-0144-03 Radius with weatherstrip (1-1/8" x 7-1/4")	\$18

## 4920, 8300 Faceplates

MODEL & FINISHES	313, 335, 628
24-0138-01 Flat or bevel faceplate	\$25

## 7100, 7160 Electric Strike Faceplates

MODEL & FINISHES	313, 335, 628
24-0685-01 Round corner faceplate (1-1/4" x 4-7/8")	\$23

## 7101 Electric Strike Faceplates

MODEL & FINISHES	313, 335, 628
24-0685-02 Radius faceplate (1-1/4" x 4-7/8")	\$23

## 7110 Electric Strike Faceplates

MODEL & FINISH	652
22-0558 Round corner faceplate (1-7/16" x 7-15/16")	\$23

## 7111 Electric Strike Faceplates

MODEL & FINISH	652, 630
22-0557 Round corner faceplate (1-7/16" x 10-1/4")	\$23

## 7130 Electric Strike Faceplates

MODEL & FINISHES	313, 335, 628
24-0686-01 Round corner faceplate (1-1/4" x 6-7/8")	\$28

## 7131 Electric Strike Faceplates

MODEL & FINISHES	313, 335, 628
24-0686-02 Radius faceplate (1-1/4" x 6-7/8")	\$28

## 7140, 7170 Electric Strike Faceplates

MODEL & FINISHES	313, 335, 628
24-0687-01 Radius faceplate (1-1/4" x 4-7/8")	\$23

# POWER

## PS-1 Power Supply

MODEL	PRICE
PS-1 Power supply, 12/24 VDC boxed P/S 1 Amp	\$318



## PS-LR Power Supply

MODEL	PRICE
PS-LR Power supply for exit devices with LR latch retraction option	\$806



### Kitted Option

MODEL	PRICE
BBK-LR Add-on board to the PS-LR, must be supplied with 2 each 12V - 7AH batteries (by others)	\$223

## PS-SE Power Supply

MODEL	PRICE
PS-SE Power supply for exit devices with SE motorized latch retraction option	\$652



### Kitted Option

MODEL	PRICE
BBK-SE Add-on board to the PS-SE, must be supplied with 2 each 12V - 7AH batteries (by others)	\$223

## 4612 Power Transfer Device

MODELS	PRICE
4612-1 Wire transfer, 105° swing	\$165
4612-2 Wire transfer, 180° swing	\$212
4612-1SC Wire transfer, swing clear 90° swing	\$283
4612EL-1 Wire transfer, 105° swing with ElectroLynx(TM) Adapter	\$193
4612EL-1SC Wire transfer, 90° swing with ElectroLynx(TM) Adapter	\$311



## 4603, 4605, 4606 Transformer/Rectifier/Piezo Horn

MODELS	PRICE
4603 Rectifier	\$17
4605 Transformer, 115 VAC to 12/24 VAC	\$58
4606 Plug-in transformer, 115 VAC to 24 VAC only	\$95
29-0218 Piezo electric horn	\$23
ELX ElectroLynx™ Adapter to connect Adams Rite products to the ElectroLynx system	\$33



# DEMO MOUNTS

## DEADLOCKS & DEADLATCHES

### RT1050 RITE Touch® Digital Glass Door Lock

MODEL & FINISH	PRICE
RT1050D-DEMO RITE Touch digital glass door lock with thumbturn, for all-glass doors	\$835
RT1050L-DEMO RITE Touch digital glass door lock with lever, for full-glass doors	\$835

### 2190 Dual Force® Interconnected Deadbolt/Deadlatch

MODELS & FINISH	US32D
2190-MOUNT Dual Force® 2190 Interconnected Deadbolt/Deadlatch mounted complete with electrified trim set	\$1,051

### 4300 Steel Hawk® Electrified Deadlatch

MODELS & FINISH	US32D
4300-MOUNT Steel Hawk® 4300 Electrified Deadlatch mounted complete with 4600 Heavy Duty Designer Deadlatch Lever Trim with MN designer lever	\$910

## EXIT DEVICES

### 8400 Narrow Stile Mortise Exit Device

MODELS & FINISH	628
8400MLR-MOUNT 8400 Series Narrow Stile Mortise Exit Device featuring MLR motorized latch retraction option	\$1,771

## ELECTRIC STRIKES

### 7400 UltraLine® Electric Strikes

MODELS & FINISH	PRICE
7440-MOUNT UltraLine 7440 Electric Strike mounted complete with 4-7/8" faceplate, 628 finish	\$803
74R1-MOUNT UltraLine 74R1 Electric Strike for rim exit devices with 3/4" Pullman latches mounted complete, 130 finish	\$826
74R2-MOUNT UltraLine 74R2 Electric Strike for rim exit devices with 1/2" Pullman latches mounted complete, 130 finish	\$826

**TRIM****A100-3090H Keyless Entry and Aperio® Hub Wholesale Kit**

MODELS & FINISH		626
<b>A100-3090C-MOUNT</b>	Aperio® A100 Keyless Entry Control and Aperio Hub with HID® iClass credentials, mounted complete with 4900 Heavy Duty Deadlatch, 4600 Heavy Duty Designer Deadlatch Lever Trim	\$2,799
<b>A100-3090CK-MOUNT</b>	Aperio® A100 Keyless Entry Control and Aperio Hub with keypad and HID® iClass credentials, mounted complete with 4900 Heavy Duty Deadlatch, 4600 Heavy Duty Designer Deadlatch Lever Trim	\$2,959

**3090 eForce® Keyless Entry**

MODELS & FINISH		626
<b>3090-MOUNT</b>	eForce® 3090-150 Keyless Entry Trim mounted complete with 4900 Heavy Duty Deadlatch	\$1,224

**4600 Heavy Duty Designer Deadlatch Handles**

MODELS & FINISH		US32D
<b>4600-MOUNT</b>	4600 Heavy Duty Designer Deadlatch Lever Trim with MN designer levers, mounted complete with Dual Force® 2190 Deadbolt/Deadlatch (lock)	\$1,102

## GENERAL INFORMATION

### Adams Rite Limited Warranty

Adams Rite warrants that its products sold under the Adams Rite brand in the United States of America are warranted free from defects in workmanship and materials under normal use and service. This warranty does not cover defects or damage arising from improper installation, lack of or improper maintenance, improper storage, shipping and handling, corrosion, erosion, ordinary wear and tear, misuse, abuse, accident, unauthorized service, or use with unauthorized non-Adams Rite products or parts. This warranty is void if any modification is made to the product, regardless of whether the modification causes or contributes to the alleged defect. All modifications are made at the risk of the party making the modification.

Should any defect of manufacture (in material or workmanship) occur in its products, Adams Rite, upon prompt notification and proof to its satisfaction that the product was defective in manufacture for the use intended by Adams Rite, will at its option, exchange the product, repair the product, or refund the price charged by Adams Rite, FOB factory within the stated time frame listed below.

- 10 years on all mechanical products from the date of manufacture
- 5 years on the following electromechanical product categories from the date of manufacture, deadlocks, dead latches, exit devices\*, electric strikes, trims, power supply & accessories
  - \* NOTE: The SE option (motorized electric latch retraction) is supported by a 1-year electro mechanical warranty. When powered by an Adams Rite PS-SE power supply the 1-year warranty is upgraded to 5 years
- 3 years on the following access control products from the date of manufacture, RT1050, 3090-150, 3090P/C & A100 (Integrated Wiegand).

### General RMA Procedure

Product repair or replacement, or associated charges, will not be accepted under this warranty unless prior authorization from Adams Rite has been given. Upon receipt of products returned for repair or replacement, Adams Rite will determine whether products qualify for repair or replacement under this warranty. Adams Rite has no liability to pay any costs of repair performed by anyone other than qualified personnel authorized by Adams Rite prior to the work being done.

Written notice of a product or component part believed to be defective as covered by this warranty should be sent to Adams Rite, 10027 S. 51st Street, Suite 102, Phoenix, Arizona 85044 or [customer.care@assaabloy.com](mailto:customer.care@assaabloy.com) and should include your name and address, an identification of the product or component part and a brief description of the defect.

Notice of a product or component part believed to be defective as covered by this warranty may also be accepted over the telephone by Adams Rite, 800.872.3267

#### CUSTOMER CARE FORM (CCF)

Upon receipt of such notice, if the customer has an account with Adams Rite or a valid credit card, an advance replacement product may be ordered whereby Adams Rite will ship a replacement product to the customer free of charge. If Adams Rite does not receive the original defective product from the customer within 60 days, Adams Rite will charge the customer's account or credit card for the price of the advanced replacement product plus freight costs. Upon inspection of the returned product by Adams Rite, a decision will be made whether or not to charge the customer for the advanced replacement Adams Rite product. This decision will be made solely by Adams Rite in accordance with the provisions of these Terms. Obsolete products will not be accepted for return. Return Material Authorizations (RMAs) will be closed if the goods are not received within 60 days of issuance.

If Adams Rite receives original defective product from the customer within 60 days of RMA issuance, and if the customer is requesting credit for the defective material, the customer must reference the valid Adams Rite Purchase Order number upon which the product was originally ordered. If the original Purchase Order number is not available, at Adams Rite's option a credit may be issued at the customer's current cost. This decision will be made solely by Adams Rite in accordance with the provisions of these Terms.

Transportation charges and insurance on all returned materials must be prepaid by the purchaser when merchandise is ordered in error. On goods returned for customer convenience, when the purchaser returns materials in compliance with these Terms which are accepted by Adams Rite, the purchaser may be issued a credit for 65% of the purchase price, with 35% charged by Adams Rite for handling and reprocessing. All refunds will be in the form of a credit.

### Cancellation

As an industry leader, Adams Rite is committed to maintaining the highest standard of quality and ensuring strict compliance to industry codes. Adams Rite's proud history of customer service and manufacturing agility allow quick response times to customer's changing needs, which may include special orders or product modifications. Please be advised that all product modifications require special authorization to ensure the order fully meets customer's expectations. Customers are asked to allow for an extended lead time on all special orders. Please note that at Adams Rite's option, product modifications and other special orders cannot be changed, canceled, or returned once a ship date has been provided on an order acknowledgment by Adams Rite.

Adams Rite prides itself on introducing new, industry-relevant, feature-rich products. Since new solutions will surpass the capabilities of older product lines, historical products may be subsequently discontinued. Every effort will be made to announce new product introductions as well as product discontinuations in a manner that allows customers advanced notice of these events. Once a product line is discontinued orders will be fulfilled in order of receipt, although Adams Rite cannot guarantee all orders can be filled. Repair services and spare parts for discontinued product lines will be available for some reasonable time period. Adams Rite reserves the right to replace discontinued product with an equivalent product as deemed by Adams Rite.

THIS WARRANTY IS IN LIEU OF ALL OTHER EXPRESS WARRANTIES. TO THE EXTENT PERMITTED BY LAW, ALL IMPLIED WARRANTIES ARE LIMITED TO THE DURATION OF THIS WARRANTY. ADAMS RITE IS A DIVISION OF HANCHETT ENTRY SYSTEMS, INC. HANCHETT ENTRY SYSTEMS, INC. SHALL NOT BE LIABLE FOR ANY INCIDENTAL OR CONSEQUENTIAL DAMAGES. SOME STATES DO NOT ALLOW LIMITATIONS ON HOW LONG AN IMPLIED WARRANTY LASTS OR THE EXCLUSION OR LIMITATION OF INCIDENTAL OR CONSEQUENTIAL DAMAGES, SO THE ABOVE LIMITATION OR EXCLUSIONS MAY NOT APPLY TO YOU. THIS WARRANTY GIVES YOU SPECIFIC LEGAL RIGHTS, AND YOU MAY ALSO HAVE OTHER RIGHTS WHICH VARY FROM STATE TO STATE.

### Canada

Customers purchasing from Door Security Solutions Canada can find Canadian Terms and Conditions at [www.assaabloy.ca/terms](http://www.assaabloy.ca/terms).





The ASSA ABLOY Group is the global leader in access solutions. Every day, we help billions of people experience a more open world.

ASSA ABLOY Opening Solutions leads the development within door openings and products for access solutions in homes, businesses and institutions. Our offering includes doors, frames, door and window hardware, locks, perimeter fencing, access control and service.

## USA

800.872.3267 | f: 800.232.7329 | [adamsrite.com](http://adamsrite.com)

[customerservice.adamsrite@assaabloy.com](mailto:customerservice.adamsrite@assaabloy.com)

[techsupport.adamsrite@assaabloy.com](mailto:techsupport.adamsrite@assaabloy.com)

[orders.adamsrite@assaabloy.com](mailto:orders.adamsrite@assaabloy.com)

## Canada

800.461.3007 | f: 800.461.8989 | [assaabloydss.ca](http://assaabloydss.ca)

[sales.dss.ca@assaabloy.com](mailto:sales.dss.ca@assaabloy.com)

[orders.dss.ca@assaabloy.com](mailto:orders.dss.ca@assaabloy.com)

Patent pending and/or patent [www.assaabloydss.com/patents](http://www.assaabloydss.com/patents).  
Copyright © 2019, Hanchett Entry Systems, Inc., an ASSA ABLOY Group company.  
All rights reserved. Reproduction in whole or in part without the express written permission of Hanchett Entry Systems, Inc. is prohibited. AR-053-1019



**ASSA ABLOY**

Experience a safer  
and more open world